

PREPARED BY :    DATE	 TFT Liquid Crystal Display Group SHARP CORPORATION  <b>SPECIFICATION</b>	SPEC No. LD-11104A
		FILE No.
APPROVED BY :    DATE		ISSUE : Mar. 4 1999
		PAGE : 17 pages
		APPLICABLE GROUP TFT Liquid Crystal Display Group

DEVICE SPECIFICATION FOR  
**TFT-LCD Module**  
 MODEL No.  
**LQ150X1DG16**

**NOTICE**

The intended purpose of this product does not include military vehicles or civilian aircraft cockpit applications. Should any product be used in these applications no warranty or representation is made that the product is free from claims of patent infringement and no indemnification against such claims will be provided.

CUSTOMER'S APPROVAL

DATE \_\_\_\_\_

BY \_\_\_\_\_

PRESENTED

BY Makoto Takeda

M. TAKEDA

Assistant Department General Manager

Development Engineering Department

TFT Division 2

TFT LIQUID CRYSTAL DISPLAY GROUP

SHARP CORPORATION





## 1. Application

This specifications applies to a color TFT-LCD module, LQ150X1DG16.

- ©These specification sheets are the proprietary product of SHARP CORPORATION("SHARP) and include materials protected under copyright of SHARP. Do not reproduce or cause any third party to reproduce them in any form or by any means, electronic or mechanical, for any purpose, in whole or in part, without the express written permission of SHARP .
- ©The device listed in these specification sheets was designed and manufactured for use in OA equipment .
- ©In case of using the device for applications such as control and safety equipment for transportation(aircraft, trains, automobiles, etc. ), rescue and security equipment and various safety related equipment which require higher reliability and safety, take into consideration that appropriate measures such as fail-safe functions and redundant system design should be taken .
- ©Do not use the device for equipment that requires an extreme level of reliability, such as aerospace applications, telecommunication equipment(trunk lines), nuclear power control equipment and medical or other equipment for life support .
- ©SHARP assumes no responsibility for any damage resulting from the use of the device which does not comply with the instructions and the precautions specified in these specification sheets .
- ©Contact and consult with a SHARP sales representative for any questions about this device .

## 2. Overview

This module is a color active matrix LCD module incorporating amorphous silicon TFT (Thin Film Transistor). It is composed of a color TFT-LCD panel, driver ICs, control circuit, power supply circuit and a back light unit. Graphics and texts can be displayed 1024×3×768 dots on a panel with 262,144 colors by supplying 36 bit data signals(6 bit×2pixel×RGB), four timing signals, +5V DC supply voltage for TFT-LCD panel driving and supply voltage for back light .

It is a wide viewing-angle-module (Vertical viewing angle:120° Horizontal viewing angle:140° ).

Input signal timing conform with 75Hz mode of VESA standard.

## 3. Mechanical Specifications

Parameter	Specifications	Unit
Display size	38 (Diagonal)	cm
	15.0 (Diagonal)	inch
Active area	304.1 (H)×228.1 (V)	mm
Pixel format	1024 (H)×768 (V)	pixel
	(1 pixel=R+G+B dots)	
Pixel pitch	0.297 (H)×0.297 (V)	mm
Pixel configuration	R,G,B vertical stripe	
Display mode	Normally white	
Unit outline dimensions *1	355(W)×257.9 (H)×15.9(D)	mm
Mass	1400 (max.)	g
Surface treatment	Anti-glare and hard-coating 2H (Haze value = 28)	

\*1.Note: excluding back light cables .

The thickness of module (D) doesn't contain the projection .

\*2.Outline dimension is shown in Fig.1

## 4. Input Terminals

## 4-1. TFT-LCD panel driving

CN1                      The module-side connector : FX8-60S-SV (Hirose Electric Co., Ltd.)

                            The user-side connector : FX8-60P-SV (Hirose Electric Co., Ltd.)

Pin No.	Symbol	Function	Remark
1	GND	GND	
2	RB0	RED even data signal (LSB)	
3	RB1	RED even data signal	
4	RB2	RED even data signal	
5	RB3	RED even data signal	
6	RB4	RED even data signal	
7	RB5	RED even data signal (MSB)	
8	GND	GND	
9	GB0	GREEN even data signal (LSB)	
10	GB1	GREEN even data signal	
11	GB2	GREEN even data signal	
12	GB3	GREEN even data signal	
13	GB4	GREEN even data signal	
14	GB5	GREEN even data signal (MSB)	
15	GND	GND	
16	BB0	BLUE even data signal (LSB)	
17	BB1	BLUE even data signal	
18	BB2	BLUE even data signal	
19	BB3	BLUE even data signal	
20	BB4	BLUE even data signal	
21	BB5	BLUE even data signal (MSB)	
22	GND	GND	
23	RA0	RED odd data signal (LSB)	
24	RA1	RED odd data signal	
25	RA2	RED odd data signal	
26	RA3	RED odd data signal	
27	RA4	RED odd data signal	
28	RA5	RED odd data signal (MSB)	
29	GND	GND	
30	GA0	GREEN odd data signal (LSB)	
31	GA1	GREEN odd data signal	
32	GA2	GREEN odd data signal	
33	GA3	GREEN odd data signal	
34	GA4	GREEN odd data signal	
35	GA5	GREEN odd data signal (MSB)	
36	GND	GND	
37	BA0	BLUE odd data signal (LSB)	
38	BA1	BLUE odd data signal	
39	BA2	BLUE odd data signal	
40	BA3	BLUE odd data signal	

Pin No.	Symbol	Function	Remark
41	BA4	BLUE odd data signal	
42	BA5	BLUE odd data signal (MSB)	
43	GND	GND	
44	GND	GND	
45	GND	GND	
46	Vsync	Vertical synchronous signal	
47	Hsync	Horizontal synchronous signal	
48	ENAB	Data enable signal (Signal to settle the display position)	【Note 1】
49	GND	GND	
50	GND	GND	
51	CKB	Clock B signal for sampling even data signal	
52	CKA	Clock A signal for sampling odd data signal	
53	GND	GND	
54	GND	GND (Reserve)	
55	GND	GND (Reserve)	
56	MODE	Timing signal select	【Note 1】
57	Vcc	+5V power supply	
58	Vcc	+5V power supply	
59	Vcc	+5V power supply	
60	Vcc	+5V power supply	

※The shielding case is connected with GND in the module .

【Note 1】 In case MODE is fixed “Low”, the display start timing is determined by Vsync and ENAB.

The vertical display start position and horizontal display start position are determined as described in 7-1-2, 7-1-3. Do not keep ENAB “high” during operation.

In case MODE is fixed “High” or “Open”, the display start timing is determined by only ENAB.

#### 4-2. Back light driving

CN2,CN3

The module-side connector : BHR-03VS-1(JST)

The user-side connector : SM02(8.0)B-BHS-1(JST)

Pin no.	symbol	Function
1	V <sub>HIGH</sub>	Power supply for lamp (High voltage side)
2	NC	This is electrically opened.
3	V <sub>LOW</sub>	Power supply for lamp (Low voltage side)

#### 5. Absolute Maximum Ratings

Parameter	Symbol	Condition	Ratings	Unit	Remark
Input voltage	V <sub>I</sub>	T <sub>a</sub> =25°C	-0.3 ~ +5.5	V	【Note1】
+5.0V supply voltage	Vcc	T <sub>a</sub> =25°C	0 ~ +6	V	
Storage temperature	T <sub>stg</sub>	—	-25 ~ +60	°C	【Note2】
Operating temperature (Ambient)	T <sub>opa</sub>	—	0 ~ +50	°C	

【Note1】 CKA, CKB, RA0~RA5, GA0~GA5, BA0~BA5, RB0~RB5, GB0~GB5, BB0~BB5,  
Hsync, Vsync, ENAB, MODE

【Note2】 Humidity : 95%RH Max. ( T<sub>a</sub> ≤ 40°C )

Maximum wet-bulb temperature at 39°C or less ( T<sub>a</sub> > 40°C )

6. Electrical Characteristics

6-1. TFT-LCD panel driving

Ta=25°C

Parameter		Symbol	Min.	Typ.	Max.	Unit	Remark
Vcc	Supply voltage	Vcc	+4.5	+5.0	+5.5	V	【Note1】
	Current dissipation	Icc	—	300	450	mA	【Note2】
Permissible input ripple voltage		V <sub>RF</sub>	—	—	100	mVp-p	V <sub>cc</sub> =+5.0V
Input voltage (Low)		V <sub>IL</sub>	GND	—	0.6	V	【Note3】
Input voltage (High)		V <sub>IH</sub>	2.6	—	Vcc	V	【Note3】
Input current (Low)		I <sub>IL</sub>	—	—	10	μA	V <sub>I</sub> =GND 【Note3】
			—	—	400	μA	V <sub>I</sub> =GND 【Note4】
Input current (High)		I <sub>IH</sub>	—	—	10	μA	V <sub>I</sub> =Vcc 【Note3】
			—	—	600	μA	V <sub>I</sub> =Vcc 【Note4】

※ 3.3(v) logic is recommended as input signals .

【Note1】

On-off conditions for supply voltage

$0 < t_1 \leq 10\text{ms}$

$t_4 \geq 1\text{s}$

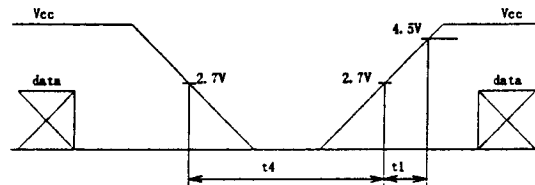

Vcc-dip conditions

- 1)  $2.7\text{V} \leq V_{cc} < 4.5\text{V}$   
 $t_d \leq 10\text{ms}$

- 2)  $V_{cc} < 2.7\text{V}$

Vcc-dip conditions should also follow the on-off conditions

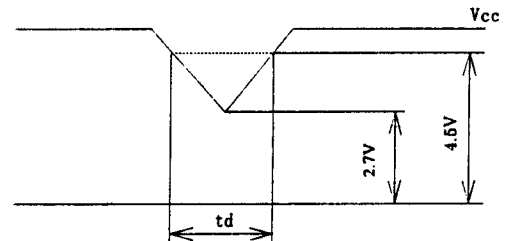

【Note2】 Typical current situation : 16-gray-bar pattern.

Vcc=+5.0V,

Gray scale : GS(4n)

$n=0 \sim 15$

The explanation of each gray scale ,GS(4n), is described below section (8).

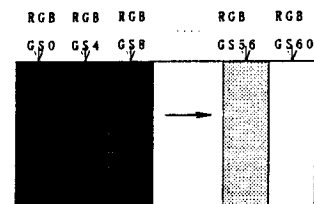

【Note3】 CKA, CKB, RA0~RA5, GA0~GA5, BA0~BA5, RB0~RB5, GB0~GB5, BB0~BB5,

Hsync, Vsync, ENAB

【Note4】 MODE

Input circuit of MODE is shown in right figure.

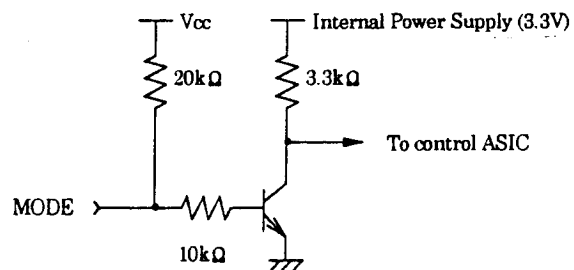

## 6-2. Back light driving

The back light system is an edge-lighting type with a couple of CCFT (Cold Cathode Fluorescent Tube). The characteristics of the lamp are shown in the following table .

The value mentioned below is at the case of one CCFT .

Parameter	Symbol	Min.	Typ.	Max.	Unit	Remark
Lamp current range	$I_L$	2.5	6.0	6.5	mArms	【Note1】
Lamp voltage	$V_L$	—	690	—	Vrms	Ta=25°C
Lamp power consumption	$P_L$	—	4.1	—	W	【Note2】
Lamp frequency	$F_L$	20	60	70	KHz	【Note3】
Kick-off voltage	$V_s$	—	—	850	Vrms	Ta=25°C 【Note4】
		—	—	1450	Vrms	Ta=0°C 【Note4】
Lamp life time	$L_L$	50000	—	—	hour	【Note5】

【Note1】 A lamp can be light in the range of lamp current shown above .

Maximum rating for current is measured by high frequency current measurement equipment connected to  $V_{LOW}$  at circuit showed below . (Note : To keep enough kick-off voltage and necessary steady voltage for CCFT .)

Lamp frequency : 20~60kHz

Ambient temperature : 0~50°C

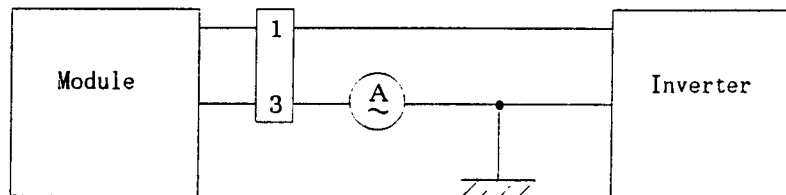

\* 3pin is  $V_{LOW}$

【Note2】 Referential data per one CCFT by calculation ( $I_L \times V_L$ ).

The data doesn't include loss at inverter .

【Note3】 Lamp frequency of inverter may produce interference with horizontal synchronous frequency, and this may cause horizontal beat on the display. Therefore, adjust lamp frequency, and keep inverter as far as from module or use electronic shielding between inverter and module to avoid interference.

【Note4】 The voltage above this value should be applied to the lamp for more than 1 second to startup. Otherwise the lamp may not be turned on .

【Note5】 Lamp life time is defined as the time when either ① or ② occurs in the continuous operation under the condition of Ta=25°C and  $I_L=6.0 \pm 0.5$ mArms .

① Brightness becomes 50% of the original value under standard condition .

② Kick-off voltage at Ta=0°C exceeds maximum value, 1450Vrms .

《Note》 The performance of the back light, for example life time or brightness, is much influenced by the characteristics of the DC-AC inverter for the lamp .When you design or order the inverter, please make sure that a poor lighting caused by the mismatch of the back light and the inverter (miss-lighting, flicker, etc.) never occurs . When you confirm it, the module should be operated in the same condition as it is installed in your instrument .



## 7. Timing characteristics of input signals

## 7-1. H-V mode (MODE = "Low" )

Timing diagrams of input signal are shown in Fig.2 .

## 7-1-1. Timing characteristics

Parameter		Symbol	Min.	Typ.	Max.	Unit	Remark
Clock A	Frequency	1/Tc	25	32.5	40	MHz	
	Clock B	High time	Tch	9	—	—	ns
Low time		Tcl	9	—	—	ns	
Duty ratio		Tch/ Tcl	0.67	1.00	1.50	—	
Data	Setup time	Tds	8	—	—	ns	
	Hold time	Tdh	8	—	—	ns	
Horizontal sync. signal	Cycle	TH	16.6	20.7	—	$\mu s$	
			528	672	860	clock	
	Pulse width	THp	2	68	—	clock	
Horizontal data start		THbp	—	148	—	clock	
Hsync-Clock phase difference		TFc	5	—	—	ns	
Vertical sync. signal	Cycle	TV	—	16.7	—	ms	【Note1】
			773	806	990	line	
	Pulse width	TVp	1	6	—	line	
Vertical data start		TVbp	35	35	35	line	
Hsync-Vsync phase difference		TVh	1	—	TH-THp	clock	

【Note1】 In case of lower frequency, the deterioration of display quality, flicker etc may be occurred .

## 7-1-2. Horizontal display position

- ① The horizontal display position is determined by ENAB signal and the input data corresponding to the rising edge of ENAB signal is displayed at the left end of the active area .

Parameter		symbol	Min.	Typ.	Max.	Unit	Remark
ENAB signal	Setup time	Tes	8	—	Tc-10	ns	
	Pulse width	Tep	10	512	512	clock	
Hsync-ENAB phase difference		THE	THp+1	148	TH-512	clock	

- ② Do not keep ENAB "Low" during operation.

## 7-1-3. Vertical display position

The vertical display start position is the 35th line from the falling edge of Vsync .(cf. Fig.2)



## 7-2. ENAB mode (MODE = "High" or "Open")

Timing diagrams of input signal are shown in Fig.3.

### 7-2-1. Timing characteristics

Parameter		Symbol	Min.	Typ.	Max.	Unit
Clock A	Frequency	1/Tc	25	32.5	40	MHz
	Clock B	High time	Tch	9	—	—
Low time		Tcl	9	—	—	ns
Duty ratio		Tch/ Tcl	0.67	1.00	1.50	—
Data	Setup time	Tds	8	—	—	ns
	Hold time	Tdh	8	—	—	ns
Data enable signal	Setup time	Tes	8	—	Tc-10	ns
	Horizontal period	TH	16.6	20.7	—	$\mu$ s
			528	672	860	clock
	Horizontal period (High)	THp	10	512	512	clock
	Vertical period	TV	770	806	990	line
Vertical blanking width	TVb	2	38	222	line	

【Note】 In case of using the long vertical period, the deterioration of display quality, flicker etc., may be occurred.

## 7-3. Input Data Signals and Display Position on the screen

Graphics and texts can be displayed  $1024 \times 3 \times 768$  dots on a panel with 262,144 colors by supplying 36 bit data signal (6bit/color [64 gray scale] x 3 x 2 pixels) .

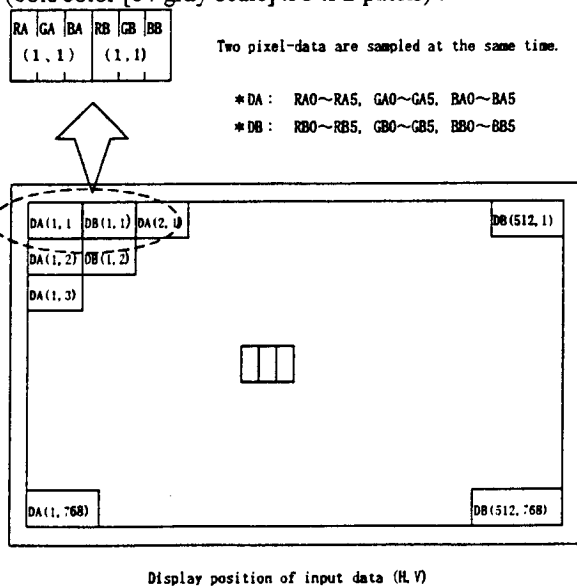

## 7-4. Sleep Mode

This LCD module stops operation, and the picture of the LCD module becomes wholly white, if ENAB signal stays "Low" for over 0.5 sec. Follow the above input signal timing for normal operation.



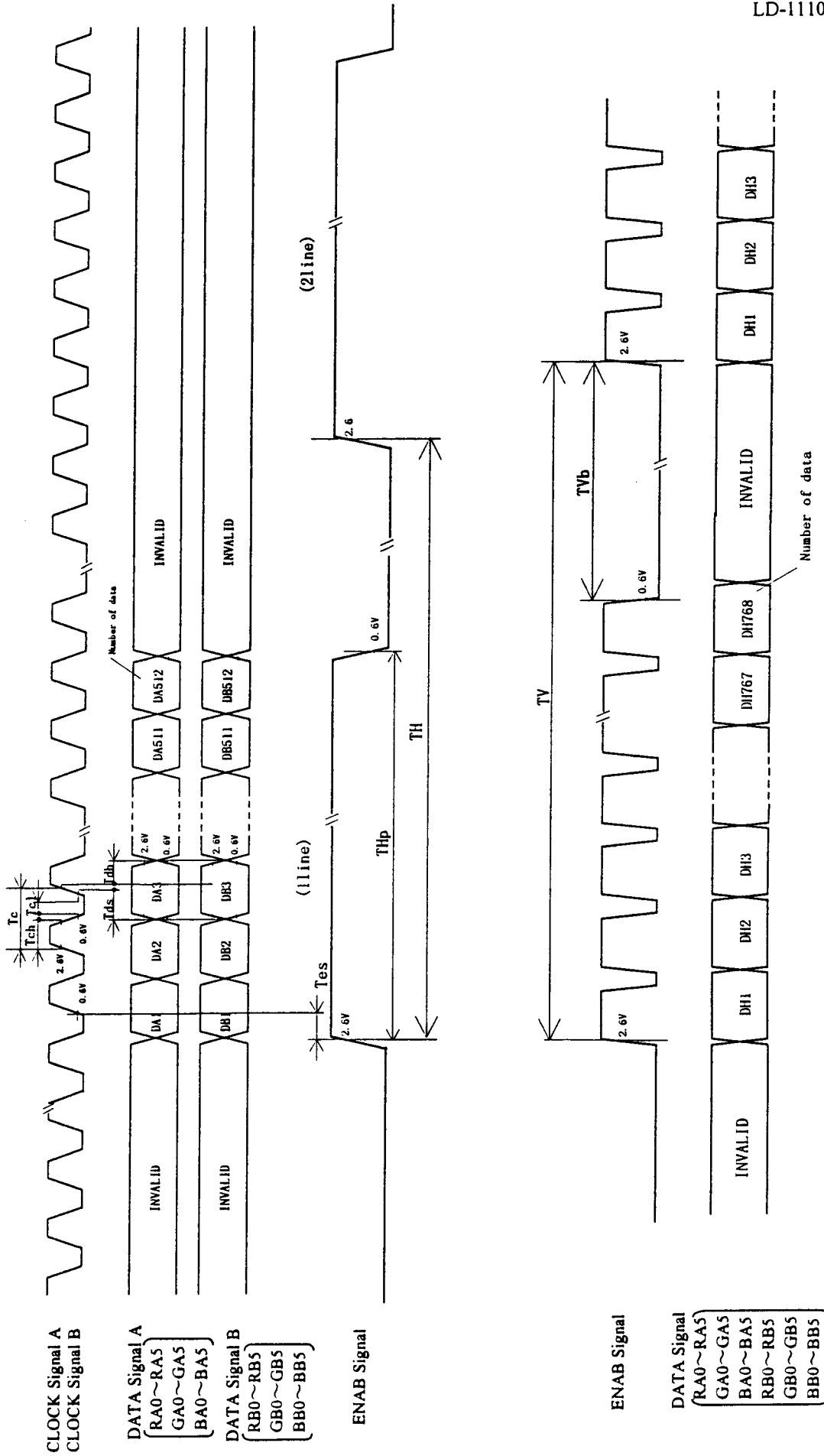

Fig.3 Input Signal Waveforms(ENAB mode)

## 8. Input Signals, Basic Display Colors and Gray Scale of Each Color

	Colors & Gray scale	Data signal																		
		Gray Scale	RA0	RA1	RA2	RA3	RA4	RA5	GA0	GA1	GA2	GA3	GA4	GA5	BA0	BA1	BA2	BA3	BA4	BA5
			RB0	RB1	RB2	RB3	RB4	RB5	GB0	GB1	GB2	GB3	GB4	GB5	BB0	BB1	BB2	BB3	BB4	BB5
Basic Color	Black	—	0	0	0	0	0	0	0	0	0	0	0	0	0	0	0	0	0	0
	Blue	—	0	0	0	0	0	0	0	0	0	0	0	0	1	1	1	1	1	1
	Green	—	0	0	0	0	0	0	1	1	1	1	1	1	0	0	0	0	0	0
	Cyan	—	0	0	0	0	0	0	1	1	1	1	1	1	1	1	1	1	1	1
	Red	—	1	1	1	1	1	1	0	0	0	0	0	0	0	0	0	0	0	0
	Magenta	—	1	1	1	1	1	1	0	0	0	0	0	0	1	1	1	1	1	1
	Yellow	—	1	1	1	1	1	1	1	1	1	1	1	1	0	0	0	0	0	0
	White	—	1	1	1	1	1	1	1	1	1	1	1	1	1	1	1	1	1	1
Gray Scale of Red	Black	GS0	0	0	0	0	0	0	0	0	0	0	0	0	0	0	0	0	0	0
	↑	GS1	1	0	0	0	0	0	0	0	0	0	0	0	0	0	0	0	0	0
	Darker	GS2	0	1	0	0	0	0	0	0	0	0	0	0	0	0	0	0	0	0
	↑	↓			↓				↓				↓							
	↓	↓			↓				↓				↓							
	Brighter	GS61	1	0	1	1	1	1	0	0	0	0	0	0	0	0	0	0	0	0
	↓	GS62	0	1	1	1	1	1	0	0	0	0	0	0	0	0	0	0	0	0
	Red	GS63	1	1	1	1	1	1	0	0	0	0	0	0	0	0	0	0	0	0
Gray Scale of Green	Black	GS0	0	0	0	0	0	0	0	0	0	0	0	0	0	0	0	0	0	0
	↑	GS1	0	0	0	0	0	0	1	0	0	0	0	0	0	0	0	0	0	0
	Darker	GS2	0	0	0	0	0	0	0	1	0	0	0	0	0	0	0	0	0	0
	↑	↓			↓				↓				↓							
	↓	↓			↓				↓				↓							
	Brighter	GS61	0	0	0	0	0	0	1	0	1	1	1	1	0	0	0	0	0	0
	↓	GS62	0	0	0	0	0	0	0	1	1	1	1	1	0	0	0	0	0	0
	Green	GS63	0	0	0	0	0	0	1	1	1	1	1	1	0	0	0	0	0	0
Gray Scale of Blue	Black	GS0	0	0	0	0	0	0	0	0	0	0	0	0	0	0	0	0	0	0
	↑	GS1	0	0	0	0	0	0	0	0	0	0	0	0	1	0	0	0	0	0
	Darker	GS2	0	0	0	0	0	0	0	0	0	0	0	0	0	1	0	0	0	0
	↑	↓			↓				↓				↓							
	↓	↓			↓				↓				↓							
	Brighter	GS61	0	0	0	0	0	0	0	0	0	0	0	0	1	0	1	1	1	1
	↓	GS62	0	0	0	0	0	0	0	0	0	0	0	0	0	1	1	1	1	1
	Blue	GS63	0	0	0	0	0	0	0	0	0	0	0	0	1	1	1	1	1	1

0 : Low level voltage, 1 : High level voltage

Each basic color can be displayed in 64 gray scales from 6 bit data signals. According to the combination of total 18 bit data signals, the 262,144-color display can be achieved on the screen.

## 9. Optical Characteristics

Ta=25°C, Vcc=+5V

Parameter		Symbol	Condition	Min.	Typ.	Max.	Unit	Remark
Viewing angle range	Horizontal	$\theta 21, \theta 22$	CR>5	60	70	—	Deg.	【Note1,4】
	Vertical	$\theta 11$		45	60	—	Deg.	
		$\theta 12$		50	60	—	Deg.	
Contrast ratio		C R n	$\theta = 0^\circ$	200	300	—		【Note2,4】
Response time	Rise	$\tau r$	$\theta = 0^\circ$	—	10	25	m s	【Note3,4】
	Decay	$\tau d$		—	35	50	m s	
Chromaticity of white		x		0.283	0.313	0.343		【Note4】
		y		0.299	0.329	0.359		
Chromaticity of red		x		0.548	0.578	0.608		【Note4】
		y		0.302	0.332	0.362		
Chromaticity of green		x		0.280	0.310	0.340		【Note4】
		y		0.520	0.550	0.580		
Chromaticity of blue		x		0.123	0.153	0.183		【Note4】
		y		0.100	0.130	0.160		
Luminance of white		$Y_{L1}$		150	200	—	cd/m <sup>2</sup>	$I_L=6.0\text{mArms}$ 【Note4】
White Uniformity		$\delta_w$		—	—	1.35		【Note5】

▲ 1

※The measurement shall be executed 30 minutes after lighting at rating .

(typical condition: $I_L=6.0\text{mArms}$ )

The optical characteristics shall be measured in a dark room or equivalent state with the method shown in Fig.4 below .

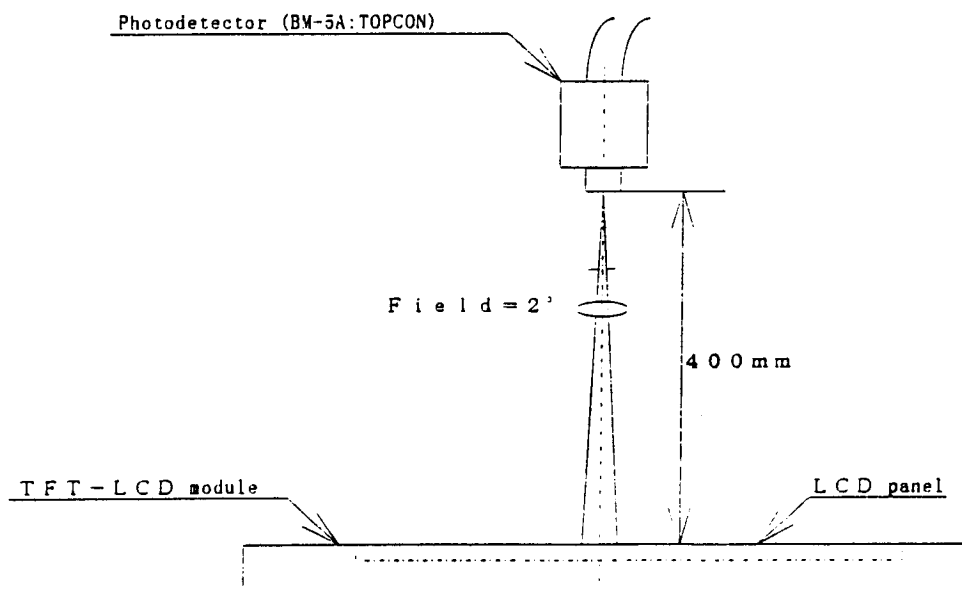

**【Note1】** Definitions of viewing angle range:

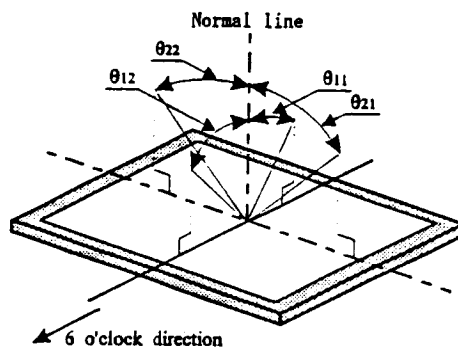

**【Note2】** Definition of contrast ratio:

The contrast ratio is defined as the following .

$$\text{Contrast Ratio (CR)} = \frac{\text{Luminance (brightness) with all pixels white}}{\text{Luminance (brightness) with all pixels black}}$$

**【Note3】** Definition of response time:

The response time is defined as the following figure and shall be measured by switching the input signal for "black" and "white" .

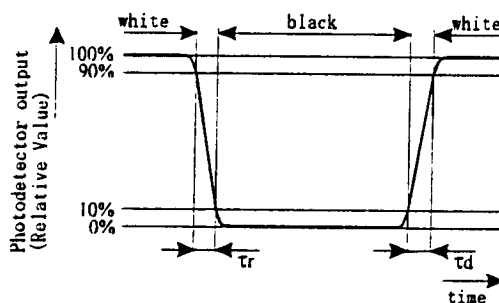

**【Note4】** This shall be measured at center of the screen .

**【Note5】** Definition of white uniformity:

White uniformity is defined as the following with five measurements (A~E) .

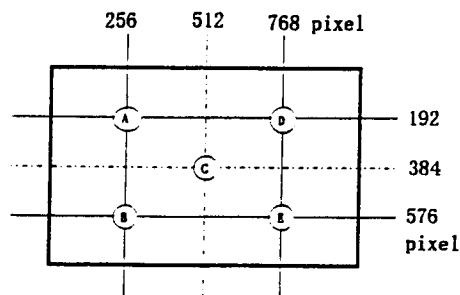

$$\delta_w = \frac{\text{Maximum Luminance of five points (brightness)}}{\text{Minimum Luminance of five points (brightness)}}$$

## 10. Handling Precautions

- a) Be sure to turn off the power supply when inserting or disconnecting the cable .
- b) Be sure to design the cabinet so that the module can be installed without any extra stress such as warp or twist .
- c) Since the front polarize is easily damaged, pay attention not to scratch it .
- d) Since long contact with water may cause discoloration or spots, wipe off water drop immediately .
- e) When the panel surface is soiled, wipe it with absorbent cotton or other soft cloth. .
- f) Since the panel is made of glass, it may break or crack if dropped or bumped on hard surface. Handle with care .
- g) Since CMOS LSI is used in this module, take care of static electricity and take the human earth into consideration when handling .
- h) This module has its circuitry PCBs on the rear side and should be handled carefully in order not to be stressed .
- i) Observe all other precautionary requirements in handling components .
- j) At lamp unit exchange , the screw behind the module need to be removed . So , please consider the necessity for cabinet design .
- k) When some pressure is added onto the module from rear side constantly , it causes display non-uniformity issue , functional defect , etc . So , please avoid such design .
- l) Duaring the module aging , don't put protection film on the module surface.

## 11. Packing form

- a) Piling number of cartons : 5 cartons
- b) Packing quantity in one carton : 5 modules
- c) Carton size : 410mm (W)×500mm (D) ×255mm (H)
- d) Total mass of one carton filled with full modules : 8850 g
- e) Packing form is shown in Fig .5



## 12. Reliability test items

No.	Test item	Conditions
1	High temperature storage test	Ta=60°C 240h
2	Low temperature storage test	Ta=-25°C 240h
3	High temperature & high humidity operation test	Ta=40°C ; 95%RH 240h (No condensation)
4	High temperature operation test	Ta=50°C 240h (The panel temp. must be less than 60°C)
5	Low temperature operation test	Ta=0°C 240H
6	Vibration test (non- operating)	Frequency : 10~57Hz/Vibration width (one said) : 0.075mm : 58~500Hz/Gravity : 9.8m/s <sup>2</sup> Sweep time : 11minutes Test period : 3 hours (1 hours for each direction X,Y,Z)
7	Shock test (non- operating)	Max, gravity : 490m/s <sup>2</sup> Pulse width : 11 ms, sine wave Direction : ±X, ±Y, ±Z once for each direction

## 【Result Evaluation Criteria】

Under the display quality test conditions with normal operation state, these shall be no change which may affect practical display function .

## 13. Others

1) Lot No. and indication Label:

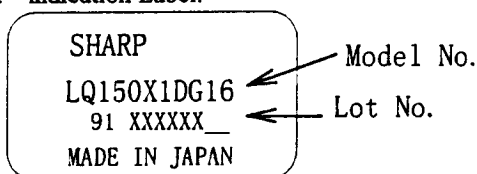

How to express Lot No.

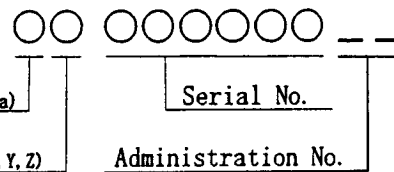

- 2) Adjusting volume have been set optimally before shipment, so do not change any adjusted value .  
If adjusted value is changed, the specification may not be satisfied .
- 3) Disassembling the module can cause permanent damage and should be strictly avoided .
- 4) Please be careful since image retention may occur when a fixed pattern is displayed for a long time .
- 5) When any question or issue occurs , it shall be solved by mutual discussion .



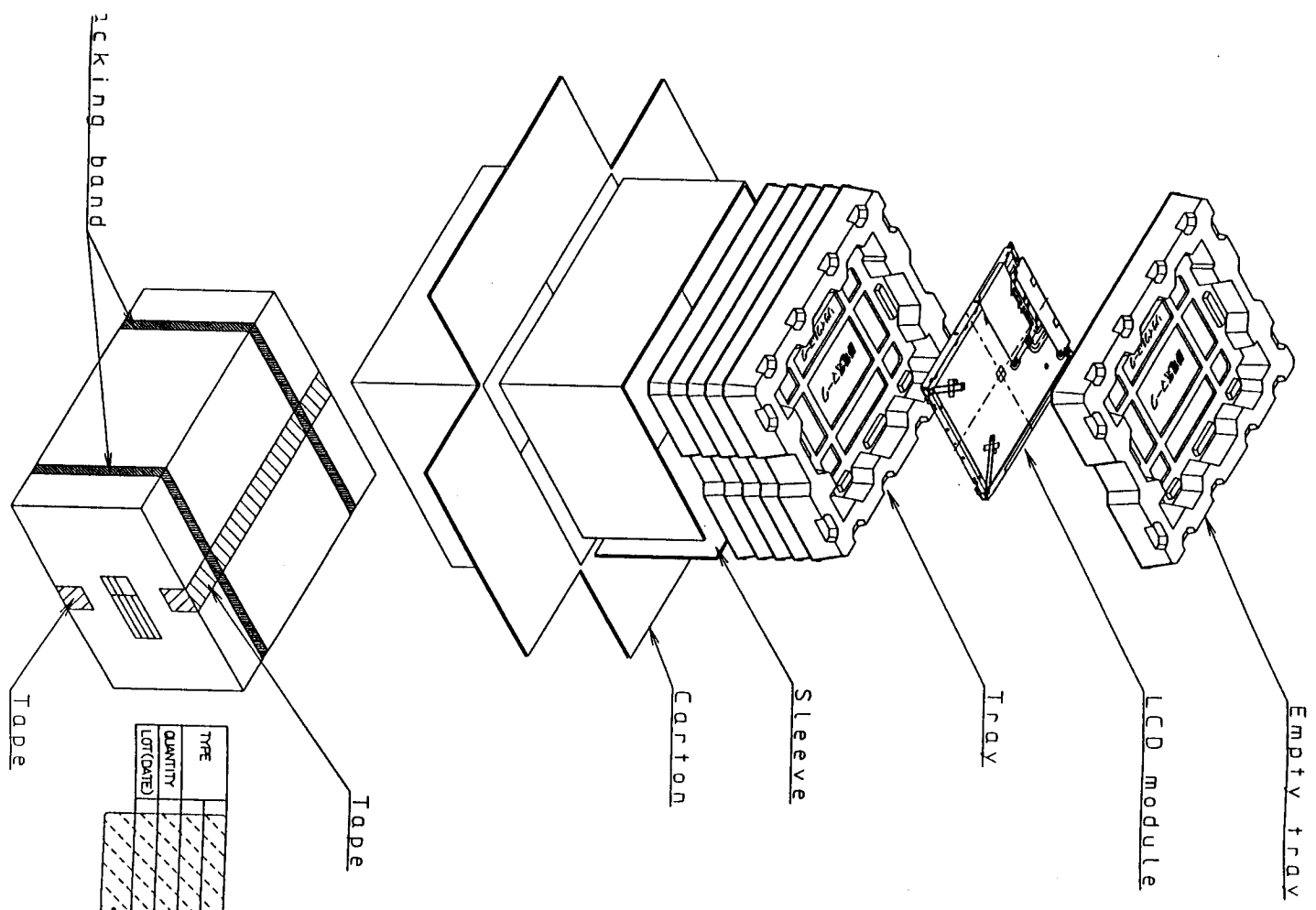

- Packing barcode label -

仕掛品番: (4S)L0150X1D616	①
Lot No. : (1T)1998.05.15 1	②
Quantity: (0) 5 pcs	③
ユーザー品番 :	④
5桁-7桁の数字	⑤

- ① Model No.
- ② Lot No. (Date)
- ③ Quantity
- ④ User model No.
- ⑤ Sharp model No.

Fig. 5 PACKING FOR

TFT, Monitor, LQ150X1DG16