

Fast Switching Diode

Features

- Silicon Epitaxial Planar Diode
- Electrical data identical with the device 1N4150
- Quadro Melf package

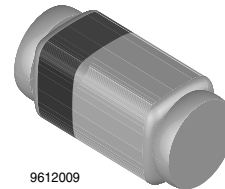

Applications

High speed switch and general purpose use in computer and industrial applications

Mechanical Data

Case:QuadroMELF Glass Case (SOD-80)

Weight: approx. 34 mg

Cathode Band Color: Black

Packaging Codes/Options:

GS18 / 10 k per 13" reel (8 mm tape), 10 k/box

GS08 / 2.5 k per 7" reel (8 mm tape), 12.5 k/box

Parts Table

Part	Type differentiation	Ordering code	Remarks
LS4150	$V_{RRM} = 50\text{ V}$	LS4150-GS18 or LS4150-GS08	Tape and Reel

Absolute Maximum Ratings

$T_{amb} = 25\text{ }^{\circ}\text{C}$, unless otherwise specified

Parameter	Test condition	Symbol	Value	Unit
Repetitive peak reverse voltage		V_{RRM}	50	V
Reverse voltage		V_R	50	V
Peak forward surge current	$t_p = 1\text{ }\mu\text{s}$	I_{FSM}	4	A
Forward current		I_F	600	mA
Average forward current	$V_R = 0$	I_{FAV}	300	mA
Power dissipation		P_V	500	mW

Thermal Characteristics

$T_{amb} = 25\text{ }^{\circ}\text{C}$, unless otherwise specified

Parameter	Test condition	Symbol	Value	Unit
Junction ambient	on PC board 50 mm x 50 mm x 1.6 mm	R_{thJA}	500	K/W
Junction temperature		T_j	175	$^{\circ}\text{C}$
Storage temperature range		T_{stg}	- 65 to + 175	$^{\circ}\text{C}$

Electrical Characteristics

$T_{amb} = 25\text{ }^{\circ}\text{C}$, unless otherwise specified

Parameter	Test condition	Symbol	Min	Typ.	Max	Unit
Forward voltage	$I_F = 1\text{ mA}$	V_F	0.54		0.62	V
	$I_F = 10\text{ mA}$	V_F	0.66		0.74	V
	$I_F = 50\text{ mA}$	V_F	0.76		0.86	V
	$I_F = 100\text{ mA}$	V_F	0.82		0.92	V
	$I_F = 200\text{ mA}$	V_F	0.87		1.0	V
Reverse current	$V_R = 50\text{ V}$	I_R			100	nA
	$V_R = 50\text{ V}, T_j = 150\text{ }^{\circ}\text{C}$	I_R			100	nA
Diode capacitance	$V_R = 0, f = 1\text{ MHz}, V_{HF} = 50\text{ mV}$	C_D			2.5	pF
Reverse recovery time	$I_F = I_R = 10\text{ to }100\text{ mA},$ $i_R = 0.1 \times I_R, R_L = 100\text{ }\Omega$	t_{rr}			4	ns

Typical Characteristics ($T_{amb} = 25\text{ }^{\circ}\text{C}$ unless otherwise specified)

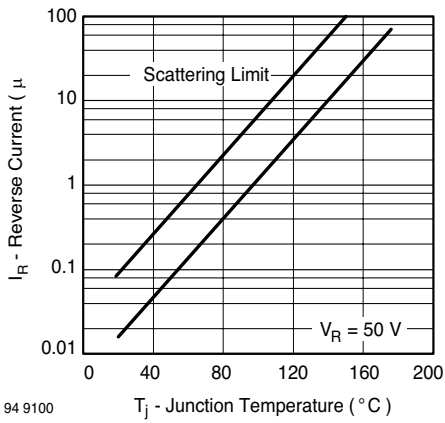

Fig. 1 Reverse Current vs. Junction Temperature

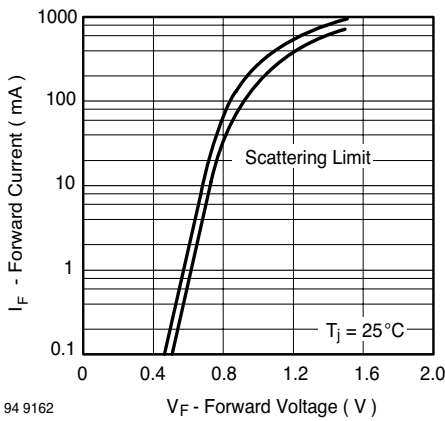
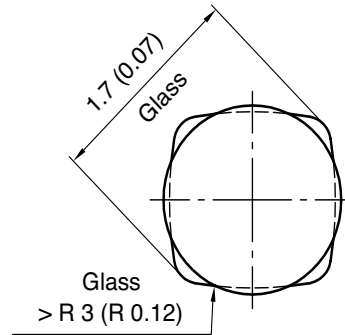
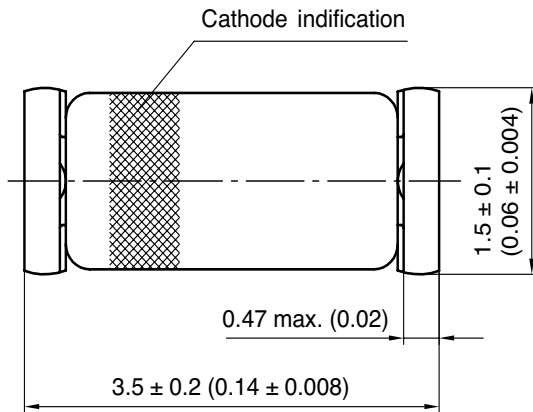
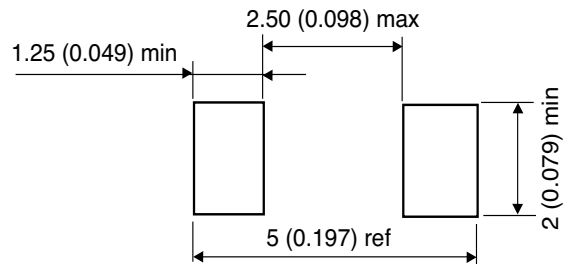
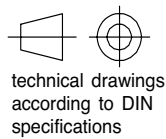

Fig. 2 Forward Current vs. Forward Voltage

Package Dimensions in mm (Inches)



Mounting Pad Layout



Glass case
Quadro Melf / SOD 80
JEDEC DO 213 AA

96 12071

Ozone Depleting Substances Policy Statement

It is the policy of **Vishay Semiconductor GmbH** to

1. Meet all present and future national and international statutory requirements.
2. Regularly and continuously improve the performance of our products, processes, distribution and operating systems with respect to their impact on the health and safety of our employees and the public, as well as their impact on the environment.

It is particular concern to control or eliminate releases of those substances into the atmosphere which are known as ozone depleting substances (ODSs).

The Montreal Protocol (1987) and its London Amendments (1990) intend to severely restrict the use of ODSs and forbid their use within the next ten years. Various national and international initiatives are pressing for an earlier ban on these substances.

Vishay Semiconductor GmbH has been able to use its policy of continuous improvements to eliminate the use of ODSs listed in the following documents.

1. Annex A, B and list of transitional substances of the Montreal Protocol and the London Amendments respectively
2. Class I and II ozone depleting substances in the Clean Air Act Amendments of 1990 by the Environmental Protection Agency (EPA) in the USA
3. Council Decision 88/540/EEC and 91/690/EEC Annex A, B and C (transitional substances) respectively.

Vishay Semiconductor GmbH can certify that our semiconductors are not manufactured with ozone depleting substances and do not contain such substances.

**We reserve the right to make changes to improve technical design
and may do so without further notice.**

Parameters can vary in different applications. All operating parameters must be validated for each customer application by the customer. Should the buyer use Vishay Semiconductors products for any unintended or unauthorized application, the buyer shall indemnify Vishay Semiconductors against all claims, costs, damages, and expenses, arising out of, directly or indirectly, any claim of personal damage, injury or death associated with such unintended or unauthorized use.

Vishay Semiconductor GmbH, P.O.B. 3535, D-74025 Heilbronn, Germany
Telephone: 49 (0)7131 67 2831, Fax number: 49 (0)7131 67 2423



Notice

Specifications of the products displayed herein are subject to change without notice. Vishay Intertechnology, Inc., or anyone on its behalf, assumes no responsibility or liability for any errors or inaccuracies.

Information contained herein is intended to provide a product description only. No license, express or implied, by estoppel or otherwise, to any intellectual property rights is granted by this document. Except as provided in Vishay's terms and conditions of sale for such products, Vishay assumes no liability whatsoever, and disclaims any express or implied warranty, relating to sale and/or use of Vishay products including liability or warranties relating to fitness for a particular purpose, merchantability, or infringement of any patent, copyright, or other intellectual property right.

The products shown herein are not designed for use in medical, life-saving, or life-sustaining applications. Customers using or selling these products for use in such applications do so at their own risk and agree to fully indemnify Vishay for any damages resulting from such improper use or sale.