

LT1030C QUADRUPLE LOW-POWER LINE DRIVER

SLLS048F – APRIL 1989 – REVISED APRIL 1998

- Low Supply Voltage . . . ± 5 V to ± 15 V
- Supply Current . . . 500 μ A Typical
- Zero Supply Current When Shut Down
- Outputs Can Be Driven ± 30 V
- Output Open When Off (3-State)
- 10-mA Output Drive
- Outputs of Several Devices Can Be Connected in Parallel
- Meets or Exceeds the Requirements of ANSI EIA/TIA-232-F Specifications
- Designed to Be Interchangeable With Linear Technology LT1030

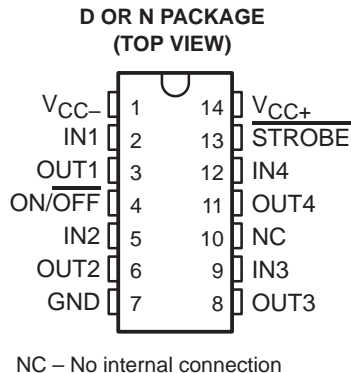

description

The LT1030C is an EIA/TIA-232-F line driver that operates over a ± 5 -V to ± 15 -V supply-voltage range on low supply current. The device can be shut down to zero supply current. Current limiting fully protects the outputs from externally applied voltages of ± 30 V. Since the output swings to within 200 mV of the positive supply and to within 1 V of the negative supply, supply-voltage requirements are minimized.

A major advantage of the LT1030C is the high-impedance output state when the device is off or powered down. This feature allows several different drivers on the same bus.

The device can be used as an EIA/TIA-232-F driver, micropower interface, or level translator, among others.

The LT1030C is characterized for operation from 0°C to 70°C.

AVAILABLE OPTIONS

PACKAGE	
SMALL OUTLINE (D)	PLASTIC DIP (N)
LT1030CD	LT1030CN

The D package is available taped and reeled. Add the suffix R to the device type (i.e., LT1030CDR).



Please be aware that an important notice concerning availability, standard warranty, and use in critical applications of Texas Instruments semiconductor products and disclaimers thereto appears at the end of this data sheet.

PRODUCTION DATA information is current as of publication date. Products conform to specifications per the terms of Texas Instruments standard warranty. Production processing does not necessarily include testing of all parameters.

 **TEXAS
INSTRUMENTS**

POST OFFICE BOX 655303 • DALLAS, TEXAS 75265

Copyright © 1998, Texas Instruments Incorporated

LT1030C QUADRUPLE LOW-POWER LINE DRIVER

SLLS048F – APRIL 1989 – REVISED APRIL 1998

logic symbol†

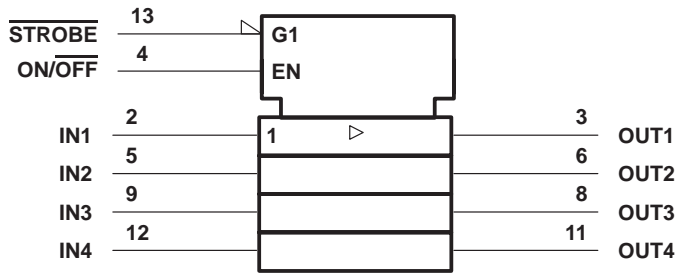

† This symbol is in accordance with ANSI/IEEE Std 91-1984 and IEC Publication 617-12.

logic diagram

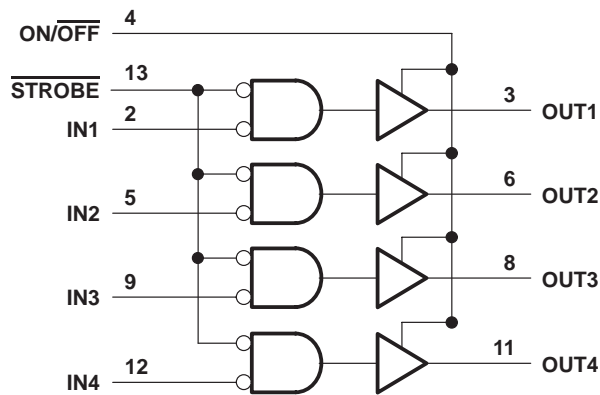

Terminal Functions

TERMINAL NAME	NO.	DESCRIPTION
GND	7	Ground terminal
IN1 IN2 IN3 IN4	2 5 9 12	Logic inputs. IN _x operate properly on TTL or CMOS levels. Output valid from $V_I = V_{CC-} + 2\text{ V}$ to 15 V. Connect to 5 V when not used.
ON/OFF	4	ON/OFF shuts down the entire circuit. It cannot be left open. For normally on operation, connect between 5 V and 10 V. If V_{IL} is at or near 0.8 V, significant settling time may be required.
OUT1 OUT2 OUT3 OUT4	3 6 8 11	Line driver outputs
STROBE	13	STROBE forces all outputs low. Drive with 3 V. Strobe terminal input impedance is approximately 2 kΩ to GND. Leave STROBE open when not used.
V _{CC+}	14	Positive supply
V _{CC-}	1	Negative supply

LT1030C QUADRUPLE LOW-POWER LINE DRIVER

SLLS048F – APRIL 1989 – REVISED APRIL 1998

absolute maximum ratings over operating free-air temperature range (unless otherwise noted)†

Supply voltage range, V_{CC+} (see Note 1)	0 V to 15 V
Supply voltage range, V_{CC-}	0 V to -15 V
Input voltage range, logic inputs, V_I	V_{CC-} to 25 V
Input voltage range at ON/OFF, V_I	0 V to 12 V
Output voltage range, V_O (any output)	$V_{CC+} - 30$ V to $V_{CC-} + 30$ V
Duration of output short circuit to ± 30 V at (or below) 25°C (see Note 2)	Unlimited
Package thermal impedance, θ_{JA} (see Note 3): D package	127°C/W
N package	78°C/W
Storage temperature range, T_{stg}	-65°C to 150°C
Lead temperature 1,6 mm (1/16 inch) from case for 10 seconds	260°C

† Stresses beyond those listed under “absolute maximum ratings” may cause permanent damage to the device. These are stress ratings only, and functional operation of the device at these or any other conditions beyond those indicated under “recommended operating conditions” is not implied. Exposure to absolute-maximum-rated conditions for extended periods may affect device reliability.

- NOTES:
1. All voltage values, except differential voltages, are with respect to GND.
 2. The output may be shorted to either supply. Temperature and/or supply voltages must be limited to ensure that the maximum dissipation rating is not exceeded.
 3. The package thermal impedance is calculated in accordance with JESD 51, except for through-hole packages, which use a trace length of zero.

recommended operating conditions

	MIN	MAX	UNIT
Supply voltage, V_{CC+}	5	15	V
Supply voltage, V_{CC-}	-5	-15	V
High-level input voltage, V_{IH} (see Note 4)	2	15	V
Low-level input voltage, V_{IL} (see Note 4)		0.8	V
Operating free-air temperature, T_A	0	70	°C

NOTE 4: These V_{IH} and V_{IL} specifications apply only for inputs IN1–IN4. For operating levels for ON/OFF, see Figure 2.

electrical characteristics over operating free-air temperature range, $V_{CC\pm} = \pm 5$ V to ± 15 V (unless otherwise noted)

PARAMETER	TEST CONDITIONS	MIN	TYP‡	MAX	UNIT
V_{OM+} Maximum positive peak output voltage swing	$I_O = -2$ mA, $T_A = 25^\circ\text{C}$	$V_{CC+} - 0.3$	$V_{CC+} - 0.1$		V
V_{OM-} Maximum negative peak output voltage swing	$I_O = 2$ mA, $T_A = 25^\circ\text{C}$		$V_{CC-} + 0.9$	$V_{CC-} + 1.4$	V
I_{IH} High-level input current	$V_I \geq 2$ V, $T_A = 25^\circ\text{C}$		2	20	μA
I_{IL} Low-level input current	$V_I \leq 0.8$ V, $T_A = 25^\circ\text{C}$		-10	-20	μA
I_I Input current, ON/OFF	$V_I = 0$		-0.1	-10	μA
	$V_I = 5$ V		30	65	
I_O Output current	$T_A = 25^\circ\text{C}$	5	12		mA
I_{OZ} Off-state output current	$V_O = \pm 15$ V, $T_A = 25^\circ\text{C}$, ON/OFF at 0.4 V		± 2	± 100	μA
I_{CC} Supply current (all outputs low)	$V_I \geq$ at 2.4 V, $I_O = 0$		500	1000	μA
$I_{CC(off)}$ Off-state supply current	ON/OFF at 0.4 V			10	μA
	ON/OFF at 0.1 V		10	150	

‡ All typical values are at $V_{CC\pm} = \pm 12$ V, $T_A = 25^\circ\text{C}$.



LT1030C QUADRUPLE LOW-POWER LINE DRIVER

SLLS048F – APRIL 1989 – REVISED APRIL 1998

operating characteristics, $V_{CC\pm} = \pm 5 \text{ V to } \pm 15 \text{ V}$, $T_A = 25^\circ\text{C}$

PARAMETER	TEST CONDITIONS	MIN	TYP†	MAX	UNIT
SR Driver slew rate	$R_L = 3 \text{ k}\Omega$, $C_L = 51 \text{ pF}$	4	15	30	V/ μs

† All typical values are at $V_{CC\pm} = \pm 12 \text{ V}$, $T_A = 25^\circ\text{C}$.

TYPICAL CHARACTERISTICS

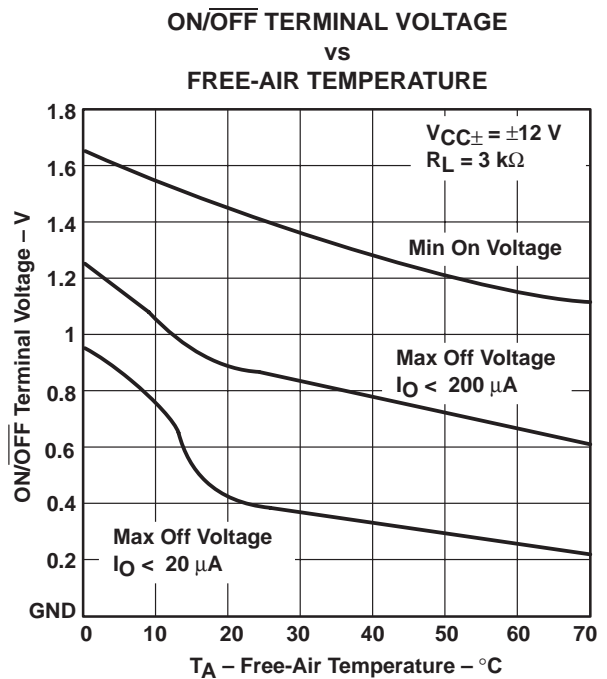
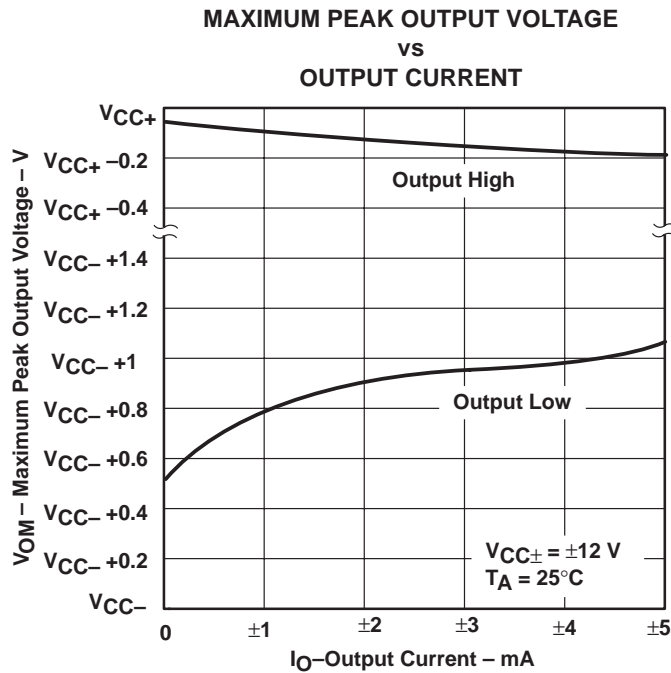

TYPICAL CHARACTERISTICS

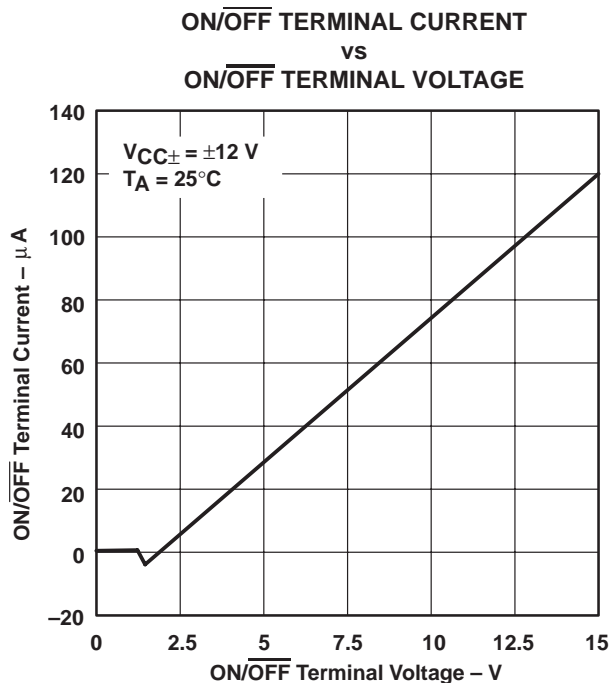
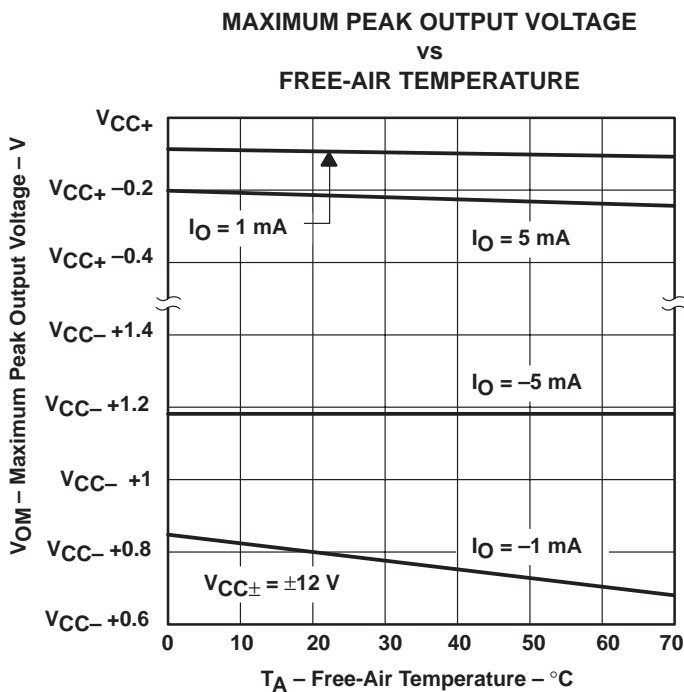

TYPICAL CHARACTERISTICS

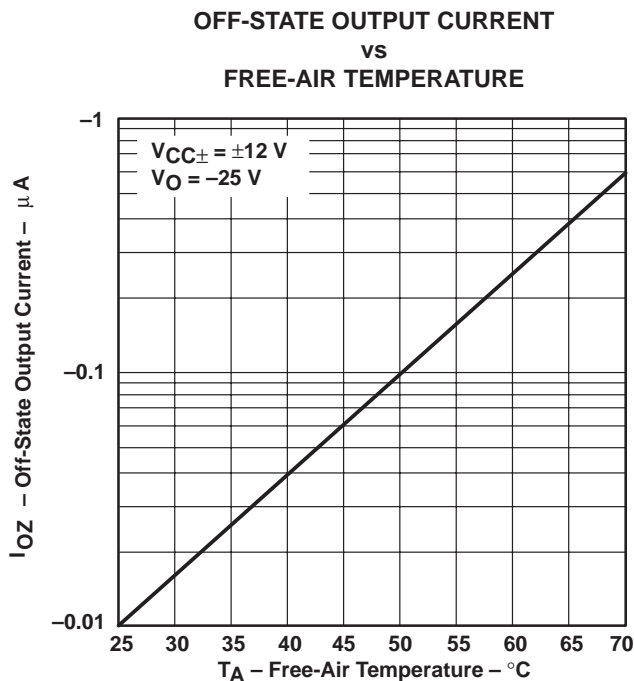
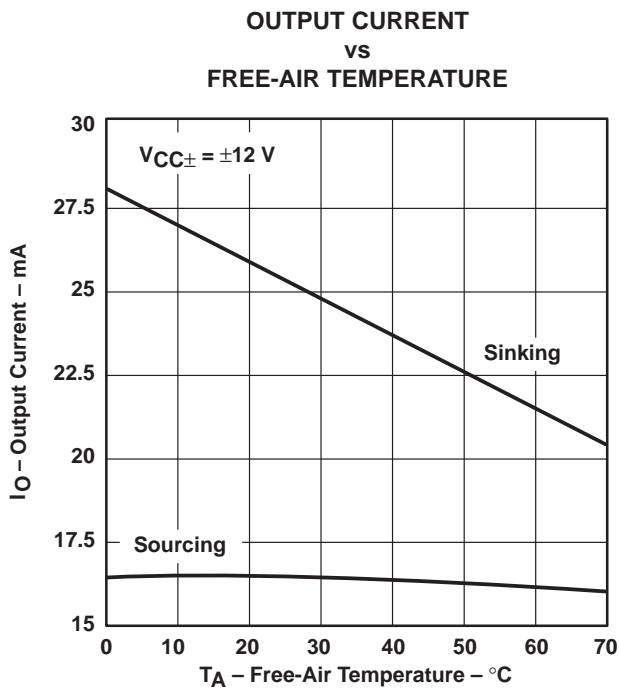

LT1030C QUADRUPLE LOW-POWER LINE DRIVER

SLLS048F – APRIL 1989 – REVISED APRIL 1998

TYPICAL CHARACTERISTICS

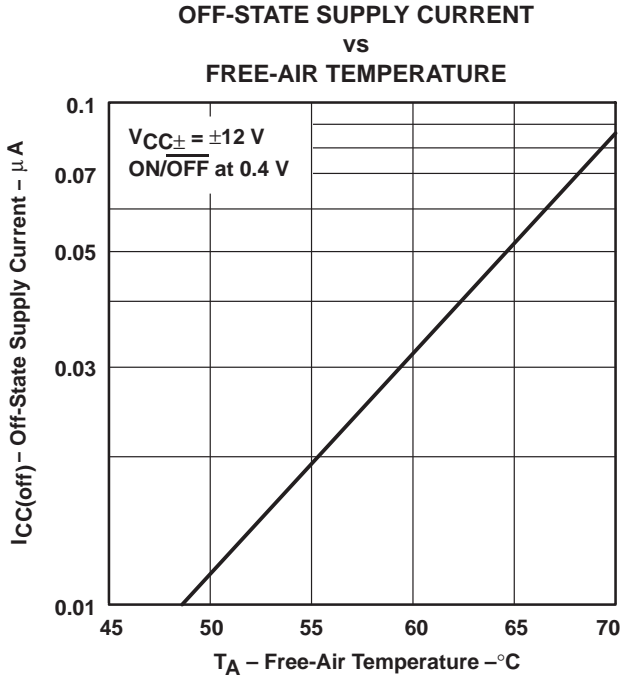

Figure 7

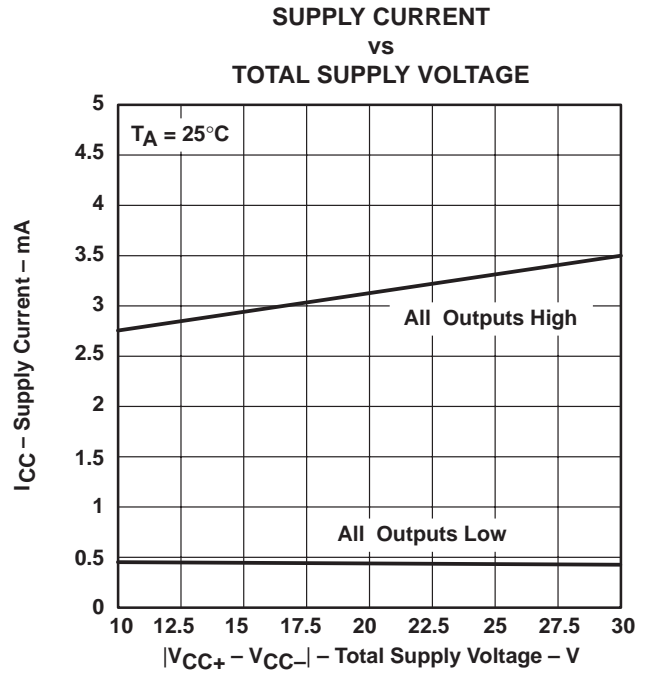

Figure 8

TYPICAL CHARACTERISTICS

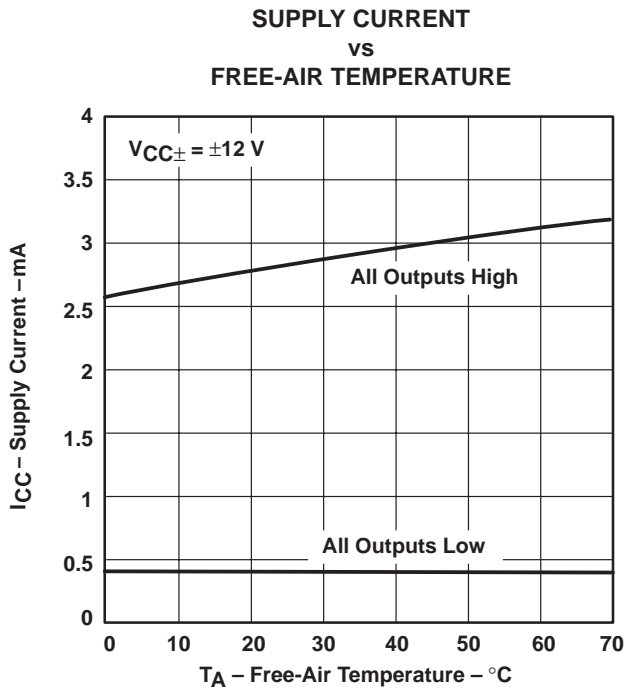

Figure 9

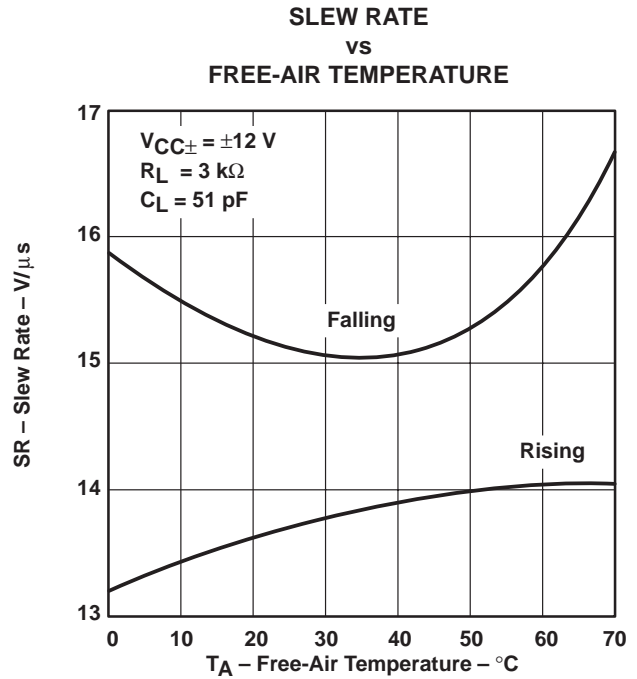

Figure 10



APPLICATION INFORMATION

forward biasing the substrate

As with other bipolar integrated circuits, forward biasing the substrate diode can cause problems. The LT1030C draws high current from V_{CC+} to GND when V_{CC-} is open circuited or pulled above ground. Connecting a diode from V_{CC-} to GND (if possible) prevents the high-current state. Any low-cost diode can be used (see Figure 11).

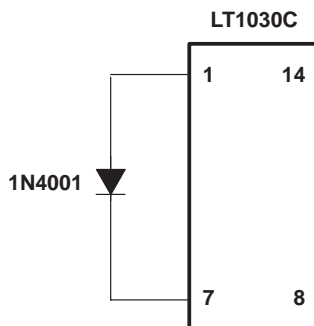

Figure 11. Connecting a Diode From V_{CC-} to GND

PACKAGING INFORMATION

Orderable Device	Status ⁽¹⁾	Package Type	Package Drawing	Pins	Package Qty	Eco Plan ⁽²⁾	Lead/Ball Finish	MSL Peak Temp ⁽³⁾
LT1030CD	ACTIVE	SOIC	D	14	50	Green (RoHS & no Sb/Br)	CU NIPDAU	Level-2-260C-1 YEAR
LT1030CDE4	ACTIVE	SOIC	D	14	50	Green (RoHS & no Sb/Br)	CU NIPDAU	Level-2-260C-1 YEAR
LT1030CDG4	ACTIVE	SOIC	D	14	50	Green (RoHS & no Sb/Br)	CU NIPDAU	Level-2-260C-1 YEAR
LT1030CDR	ACTIVE	SOIC	D	14	2500	Green (RoHS & no Sb/Br)	CU NIPDAU	Level-2-260C-1 YEAR
LT1030CDRE4	ACTIVE	SOIC	D	14	2500	Green (RoHS & no Sb/Br)	CU NIPDAU	Level-2-260C-1 YEAR
LT1030CDRG4	ACTIVE	SOIC	D	14	2500	Green (RoHS & no Sb/Br)	CU NIPDAU	Level-2-260C-1 YEAR
LT1030CN	ACTIVE	PDIP	N	14	25	Pb-Free (RoHS)	CU NIPDAU	N / A for Pkg Type
LT1030CNE4	ACTIVE	PDIP	N	14	25	Pb-Free (RoHS)	CU NIPDAU	N / A for Pkg Type

⁽¹⁾ The marketing status values are defined as follows:

ACTIVE: Product device recommended for new designs.

LIFEBUY: TI has announced that the device will be discontinued, and a lifetime-buy period is in effect.

NRND: Not recommended for new designs. Device is in production to support existing customers, but TI does not recommend using this part in a new design.

PREVIEW: Device has been announced but is not in production. Samples may or may not be available.

OBSOLETE: TI has discontinued the production of the device.

⁽²⁾ Eco Plan - The planned eco-friendly classification: Pb-Free (RoHS), Pb-Free (RoHS Exempt), or Green (RoHS & no Sb/Br) - please check <http://www.ti.com/productcontent> for the latest availability information and additional product content details.

TBD: The Pb-Free/Green conversion plan has not been defined.

Pb-Free (RoHS): TI's terms "Lead-Free" or "Pb-Free" mean semiconductor products that are compatible with the current RoHS requirements for all 6 substances, including the requirement that lead not exceed 0.1% by weight in homogeneous materials. Where designed to be soldered at high temperatures, TI Pb-Free products are suitable for use in specified lead-free processes.

Pb-Free (RoHS Exempt): This component has a RoHS exemption for either 1) lead-based flip-chip solder bumps used between the die and package, or 2) lead-based die adhesive used between the die and leadframe. The component is otherwise considered Pb-Free (RoHS compatible) as defined above.

Green (RoHS & no Sb/Br): TI defines "Green" to mean Pb-Free (RoHS compatible), and free of Bromine (Br) and Antimony (Sb) based flame retardants (Br or Sb do not exceed 0.1% by weight in homogeneous material)

⁽³⁾ MSL, Peak Temp. -- The Moisture Sensitivity Level rating according to the JEDEC industry standard classifications, and peak solder temperature.

Important Information and Disclaimer: The information provided on this page represents TI's knowledge and belief as of the date that it is provided. TI bases its knowledge and belief on information provided by third parties, and makes no representation or warranty as to the accuracy of such information. Efforts are underway to better integrate information from third parties. TI has taken and continues to take reasonable steps to provide representative and accurate information but may not have conducted destructive testing or chemical analysis on incoming materials and chemicals. TI and TI suppliers consider certain information to be proprietary, and thus CAS numbers and other limited information may not be available for release.

In no event shall TI's liability arising out of such information exceed the total purchase price of the TI part(s) at issue in this document sold by TI to Customer on an annual basis.

TAPE AND REEL INFORMATION



QUADRANT ASSIGNMENTS FOR PIN 1 ORIENTATION IN TAPE



*All dimensions are nominal

Device	Package Type	Package Drawing	Pins	SPQ	Reel Diameter (mm)	Reel Width W1 (mm)	A0 (mm)	B0 (mm)	K0 (mm)	P1 (mm)	W (mm)	Pin1 Quadrant
LT1030CDR	SOIC	D	14	2500	330.0	16.4	6.5	9.0	2.1	8.0	16.0	Q1

TAPE AND REEL BOX DIMENSIONS



*All dimensions are nominal

Device	Package Type	Package Drawing	Pins	SPQ	Length (mm)	Width (mm)	Height (mm)
LT1030CDR	SOIC	D	14	2500	346.0	346.0	33.0

D (R-PDSO-G14)

PLASTIC SMALL-OUTLINE PACKAGE



- NOTES:
- A. All linear dimensions are in inches (millimeters).
 - B. This drawing is subject to change without notice.
 - C. Body length does not include mold flash, protrusions, or gate burrs. Mold flash, protrusions, or gate burrs shall not exceed .006 (0,15) per end.
 - D. Body width does not include interlead flash. Interlead flash shall not exceed .017 (0,43) per side.
 - E. Reference JEDEC MS-012 variation AB.

N (R-PDIP-T**)

PLASTIC DUAL-IN-LINE PACKAGE

16 PINS SHOWN



- NOTES:
- A. All linear dimensions are in inches (millimeters).
 - B. This drawing is subject to change without notice.
 - C Falls within JEDEC MS-001, except 18 and 20 pin minimum body length (Dim A).
 - D The 20 pin end lead shoulder width is a vendor option, either half or full width.

4040049/E 12/2002

IMPORTANT NOTICE

Texas Instruments Incorporated and its subsidiaries (TI) reserve the right to make corrections, modifications, enhancements, improvements, and other changes to its products and services at any time and to discontinue any product or service without notice. Customers should obtain the latest relevant information before placing orders and should verify that such information is current and complete. All products are sold subject to TI's terms and conditions of sale supplied at the time of order acknowledgment.

TI warrants performance of its hardware products to the specifications applicable at the time of sale in accordance with TI's standard warranty. Testing and other quality control techniques are used to the extent TI deems necessary to support this warranty. Except where mandated by government requirements, testing of all parameters of each product is not necessarily performed.

TI assumes no liability for applications assistance or customer product design. Customers are responsible for their products and applications using TI components. To minimize the risks associated with customer products and applications, customers should provide adequate design and operating safeguards.

TI does not warrant or represent that any license, either express or implied, is granted under any TI patent right, copyright, mask work right, or other TI intellectual property right relating to any combination, machine, or process in which TI products or services are used. Information published by TI regarding third-party products or services does not constitute a license from TI to use such products or services or a warranty or endorsement thereof. Use of such information may require a license from a third party under the patents or other intellectual property of the third party, or a license from TI under the patents or other intellectual property of TI.

Reproduction of TI information in TI data books or data sheets is permissible only if reproduction is without alteration and is accompanied by all associated warranties, conditions, limitations, and notices. Reproduction of this information with alteration is an unfair and deceptive business practice. TI is not responsible or liable for such altered documentation. Information of third parties may be subject to additional restrictions.

Resale of TI products or services with statements different from or beyond the parameters stated by TI for that product or service voids all express and any implied warranties for the associated TI product or service and is an unfair and deceptive business practice. TI is not responsible or liable for any such statements.

TI products are not authorized for use in safety-critical applications (such as life support) where a failure of the TI product would reasonably be expected to cause severe personal injury or death, unless officers of the parties have executed an agreement specifically governing such use. Buyers represent that they have all necessary expertise in the safety and regulatory ramifications of their applications, and acknowledge and agree that they are solely responsible for all legal, regulatory and safety-related requirements concerning their products and any use of TI products in such safety-critical applications, notwithstanding any applications-related information or support that may be provided by TI. Further, Buyers must fully indemnify TI and its representatives against any damages arising out of the use of TI products in such safety-critical applications.

TI products are neither designed nor intended for use in military/aerospace applications or environments unless the TI products are specifically designated by TI as military-grade or "enhanced plastic." Only products designated by TI as military-grade meet military specifications. Buyers acknowledge and agree that any such use of TI products which TI has not designated as military-grade is solely at the Buyer's risk, and that they are solely responsible for compliance with all legal and regulatory requirements in connection with such use.

TI products are neither designed nor intended for use in automotive applications or environments unless the specific TI products are designated by TI as compliant with ISO/TS 16949 requirements. Buyers acknowledge and agree that, if they use any non-designated products in automotive applications, TI will not be responsible for any failure to meet such requirements.

Following are URLs where you can obtain information on other Texas Instruments products and application solutions:

Products

Amplifiers	amplifier.ti.com
Data Converters	dataconverter.ti.com
DSP	dsp.ti.com
Clocks and Timers	www.ti.com/clocks
Interface	interface.ti.com
Logic	logic.ti.com
Power Mgmt	power.ti.com
Microcontrollers	microcontroller.ti.com
RFID	www.ti-rfid.com
RF/IF and ZigBee® Solutions	www.ti.com/lprf

Applications

Audio	www.ti.com/audio
Automotive	www.ti.com/automotive
Broadband	www.ti.com/broadband
Digital Control	www.ti.com/digitalcontrol
Medical	www.ti.com/medical
Military	www.ti.com/military
Optical Networking	www.ti.com/opticalnetwork
Security	www.ti.com/security
Telephony	www.ti.com/telephony
Video & Imaging	www.ti.com/video
Wireless	www.ti.com/wireless

Mailing Address: Texas Instruments, Post Office Box 655303, Dallas, Texas 75265
Copyright © 2008, Texas Instruments Incorporated