

FEATURES

- Micropower $1.5\mu\text{W}$ (1 Sample/Second)
- Wide Supply Range— +2.8V to +16V
- High Accuracy
 - Center Error $\pm 1\text{mV}$ Max
 - Width Error $\pm 0.15\%$ Max
- Wide Input Voltage Range
V+ to Ground
- TTL Outputs with 5V Supply
- Two Independent Ground-Referred Control Inputs
- Small Size 8-Pin MiniDIP

APPLICATIONS

- Fault Detectors
- Go/No-Go Testing
- Microprocessor Power Supply Monitor

DESCRIPTION

The LTC1042 is a monolithic CMOS window comparator manufactured using Linear Technology's enhanced LTCMOS™ silicon gate process. Two high impedance voltage inputs, CENTER and WIDTH/2, define the middle and width of the comparison window. Whenever the input voltage, V_{IN} , is inside the window the WITHIN WINDOW output is high. The ABOVE WINDOW output is high whenever V_{IN} is above the window. By interchanging V_{IN} and CENTER the ABOVE WINDOW output becomes BELOW WINDOW and is high if V_{IN} is below the window.

Sampling techniques provide high impedance voltage inputs that can common-mode to both supply rails (V^+ and GND). An important feature of the inputs is their non-interaction. Also the device is effectively "chopper stabilized", giving it extremely high accuracy over all conditions of temperature, power supply and input voltage range.

Another benefit of the sampling techniques used to design the LTC1042 is the extremely low power consumption. When the device is strobed, it internally turns on the power to the comparators, samples the inputs, stores the outputs in CMOS latches and then turns off power to the comparators. This all happens in about $80\mu\text{s}$. Average power can be made small, almost arbitrarily, by lowering the strobe rate. The device can be self-strobed using an external RC network or strobed externally by driving the OSC pin with a CMOS gate.

LTCMOS™ is a trademark of Linear Technology Corp.

Battery Powered Remote Freezer Alarm

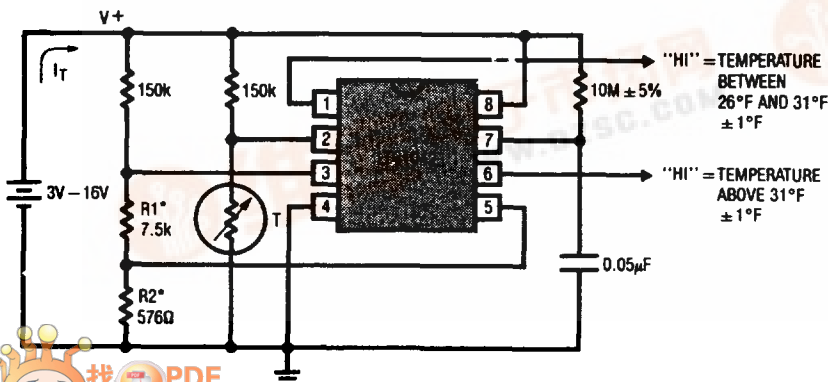

Total Supply Current vs Sampling Frequency

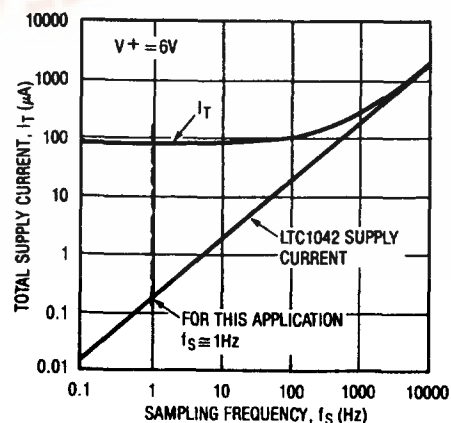

© YELLOW SPRINGS INSTRUMENT CO., INC. P/N 44007.

ALL RESISTORS $\pm 1\%$ UNLESS OTHERWISE SPECIFIED.

*OTHER TEMPERATURE BANDS MAY BE SELECTED BY CHOOSING APPROPRIATE VALUES FOR R1 AND R2.

LTC1042

ABSOLUTE MAXIMUM RATINGS

Total Supply Voltage (V^+ to GND)	18V
Input Voltage	$V^+ + 0.3V$ to $-0.3V$
Operating Temperature Range	
LTC1042C	-40°C to 85°C
LTC1042M	-55°C to 125°C
Storage Temperature Range	-55°C to 150°C
Lead Temperature (Soldering, 10 sec)	300°C
Output Short Circuit Duration	Continuous

PACKAGE/ORDER INFORMATION

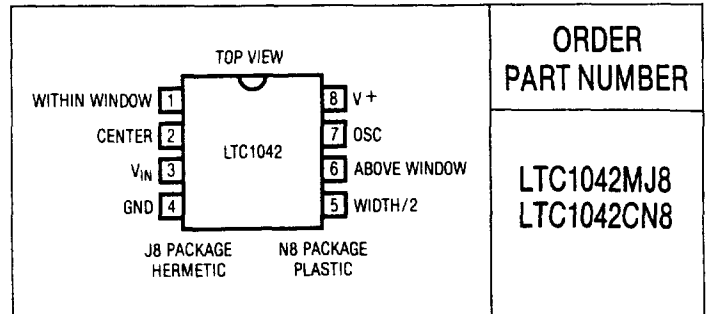

ELECTRICAL CHARACTERISTICS

Test Conditions: $T_{\text{MIN}} \leq T_A \leq T_{\text{MAX}}$ unless otherwise specified

SYMBOL	PARAMETER	TEST CONDITIONS	MIN	TYP	MAX	UNITS
	Center Error (Note 2)	$V^+ = 2.8V$ to $6V$ (Note 1)	●	± 0.3	± 1	mV
			●	± 0.05	± 0.15	% WIDTH/2
		$V^+ = 6V$ to $15V$ (Note 1)	●	± 1	± 3	mV
			●	± 0.05	± 0.15	% WIDTH/2
	Width Error (Note 3)	$V^+ = 2.8V$ to $6V$ (Note 1)	●	± 0.6	± 2	mV
			●	± 0.1	± 0.3	% WIDTH/2
		$V^+ = 6V$ to $15V$ (Note 1)	●	± 2	± 6	mV
			●	± 0.1	± 0.3	% WIDTH/2
I_{BIAS}	Input Bias Current	$V^+ = 5V$, $T_A = 25^\circ\text{C}$, OSC = GND V_{IN} , CENTER and WIDTH/2 Inputs		± 0.3		nA
R_{IN}	Average Input Resistance	$f_s = 1\text{kHz}$ (Note 4)	●	10	15	M Ω
	Input Voltage Range		●	GND	V^+	V
PSR	Power Supply Range		●	2.8	16	V
$I_{\text{S(ON)}}$	Power Supply ON Current (Note 5)	$V^+ = 5V$	●	1.2	3	mA
$I_{\text{S(OFF)}}$	Power Supply OFF Current (Note 5)	$V^+ = 5V$ LTC1042C	●	0.001	0.5	μA
		LTC1042M	●	0.001	5.0	μA
T_D	Response Time (Note 6)	$V^+ = 5V$		80	100	μs
V_{OH} V_{OL}	Output Levels					
	Logic 1 Output	$V^+ = 4.75V$, $I_{\text{OUT}} = -360\mu\text{A}$	●	2.4	4.4	V
R_{EXT}	External Timing Resistor	$V^+ = 4.75V$, $I_{\text{OUT}} = 1.6\text{mA}$	●	0.25	0.45	V
		Resistor Connected between V^+ and OSC Pin	●	100	10,000	k Ω
f_s	Sampling Frequency	$V^+ = 5V$, $T_A = 25^\circ\text{C}$ $R_{\text{EXT}} = 1\text{M}\Omega$, $C_{\text{EXT}} = 0.1\mu\text{F}$		5		Hz

The ● denotes the specifications which apply over the full operating temperature range.

Note 1: Applies over input voltage range limit and includes gain uncertainty.

Note 2: Center error = $[(V_U + V_L)/2 - \text{CENTER}]$ (where V_U = upper band limit and V_L = lower band limit).

Note 3: Width error = $(V_U - V_L - 2 \times \text{WIDTH}/2)$ (where V_U = upper band limit and V_L = lower band limit).

Note 4: R_{IN} is guaranteed by design and is not tested. $R_{\text{IN}} = 1/(f_s \times 66\text{pF})$.

Note 5: Average supply current = $T_D \times I_{\text{S(ON)}} \times f_s + (1 - T_D) f_s I_{\text{S(OFF)}}$.

Note 6: Response time is set by an internal oscillator and is independent of overdrive voltage. T_D is guaranteed by correlation test and is not directly measured.

TYPICAL PERFORMANCE CHARACTERISTICS

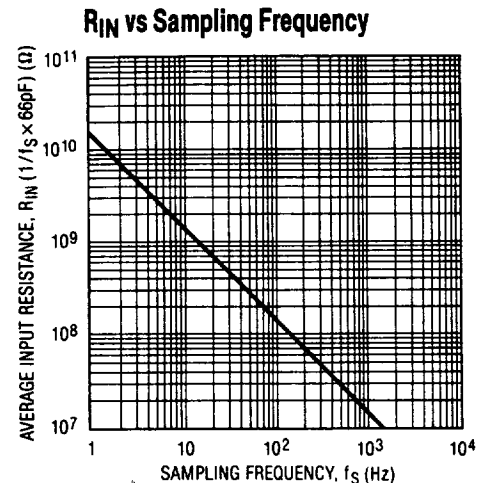
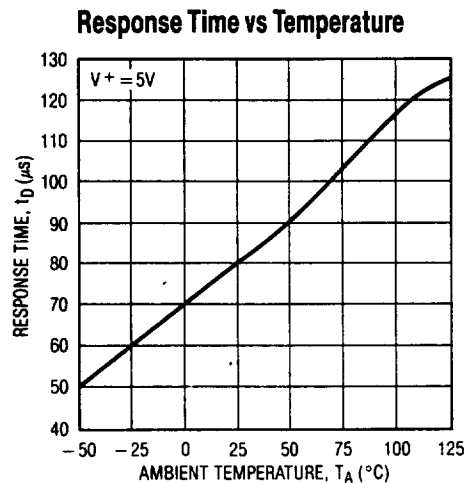
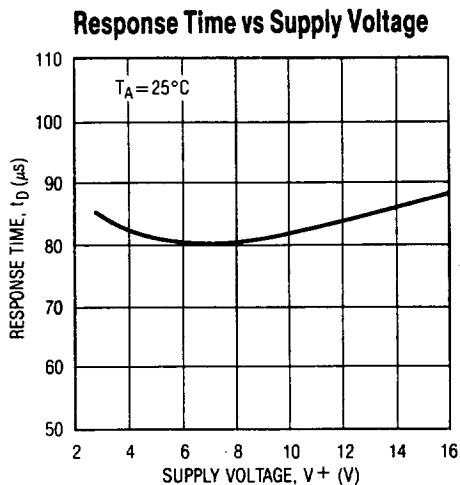
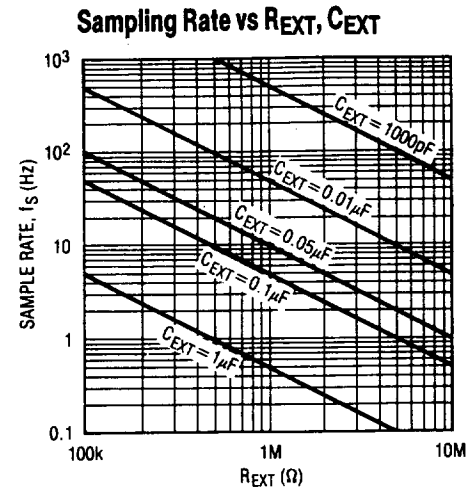
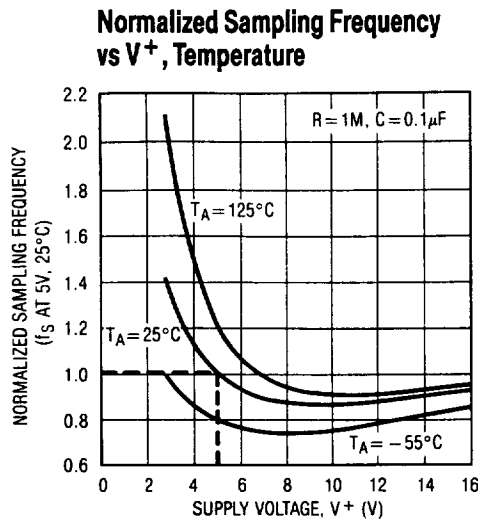
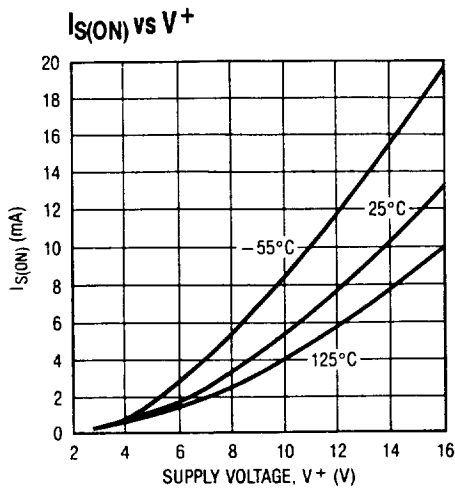

APPLICATIONS INFORMATION

The LTC1042 uses sampled data techniques to achieve its unique characteristics. It consists of two comparators, each of which has two differential inputs (Figure 1). When the sum of the voltages on a comparator's inputs is positive, the output is high; when the sum is negative, the output is low. The inputs are interconnected such that

when $(CENTER - WIDTH/2) \leq V_{IN} \leq (CENTER + WIDTH/2)$ both comparator outputs are low. In this condition V_{IN} is within the window and the WITHIN WINDOW output is high. When $V_{IN} > CENTER + WIDTH/2$, V_{IN} is above the window and the ABOVE WINDOW output is high.

LTC1042

APPLICATIONS INFORMATION

An important feature of the LTC1042 is the non-interaction of the inputs. This means the center and width of the window can be changed without one affecting the other. Also note that the width of the window is set by a ground referred signal (WIDTH/2).

Strobing

An internal oscillator allows the LTC1042 to strobe itself. The frequency of oscillation sets the sampling rate and is set with an external RC network (see typical curve, OSC frequency vs R_{EXT} , C_{EXT}). To assure oscillation, under all conditions, R_{EXT} must be between 100k Ω and 10M Ω . There is no limit to the size of C_{EXT} .

A sampling cycle is initiated on the positive going transition of the voltage on the OSC pin. When this voltage is near the positive supply, a Schmitt trigger trips and initiates the sampling cycle. A sampling cycle consists of applying power to both comparators, sampling the inputs, storing the results in CMOS output latches and turning power off. This whole process takes approximately 80 μ s. During the 80 μ s "active" time, the LTC1042 draws typically 1.2mA ($I_{S(ON)}$) at $V^+ = 5V$. Because power is consumed only during the "active" time, extremely low average power consumption can be achieved at low sample rates. For example at a sample rate of 1 sample/second the average power consumption is:

$$\text{Power} = (V^+) (I_{S(AVG)}) = 5V \times 1.2mA \times 80\mu s / 1sec = 0.48\mu W$$

At low sampling rates, R_{EXT} dominates the power consumption. R_{EXT} consumes power continuously. The average voltage at the OSC pin is approximately $V^+ / 2$. The power consumed by R_{EXT} is:

$$P(R_{EXT}) = (V^+ / 2)^2 / R_{EXT}$$

EXAMPLE: Assume $R_{EXT} = 1M\Omega$ and $V^+ = 5V$. Then:

$$P(R_{EXT}) = (2.5)^2 / 1M\Omega = 6.25\mu W$$

This is more than ten times the typical power consumed by the LTC1042 at $V^+ = 5V$ and 1 sample/second. Where power is a premium, R_{EXT} should be made as large as possible. Note that the power dissipated by R_{EXT} is *not* a function of the sampling frequency or C_{EXT} .

If high sampling rates are needed and power consumption is of secondary importance, a convenient way to get the maximum possible sampling rate is to make $R_{EXT} = 100k\Omega$ and $C_{EXT} = 0$. The sampling rate, set by the LTC1042's active time, will nominally be $\approx 10kHz$.

To synchronize the sampling of the LTC1042 to an external frequency source, the OSC pin can be driven by a CMOS gate. A CMOS gate is necessary because the input trip points of the oscillator are close to the supply rails and TTL does not have enough output swing. Externally driven, there will be a delay from the rising edge of the OSC input and the start of the sampling cycle of approximately 5 μ s.

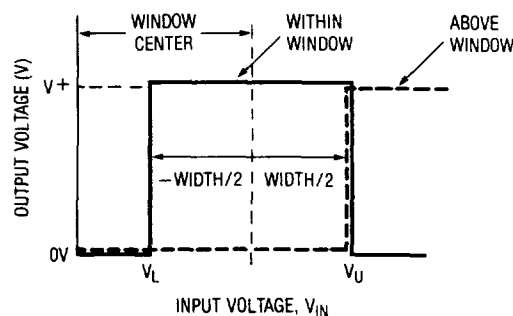
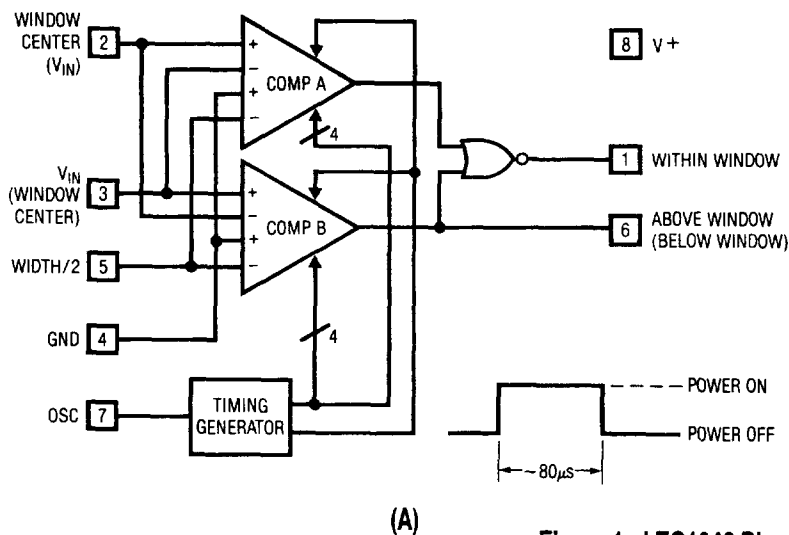

Figure 1. LTC1042 Block Diagram

APPLICATIONS INFORMATION

Input Impedance

The input impedance of the LTC1042 does not look like a classic linear comparator. CMOS switches and a precision capacitor array form the dual differential input structure. Input impedance characteristics can be determined from the equivalent circuit shown in Figure 2. The input capacitance will charge with a time constant of $R_S \times C_{IN}$. It is critical, in determining errors caused by the input charging current, that C_{IN} be fully charged during the "active" time.

For $R_S \leq 10k\Omega$

For R_S less than or equal to $10k\Omega$, C_{IN} fully charges and no error is caused by the charging current.

For $R_S > 10k\Omega$

For source resistances greater than $10k\Omega$, C_{IN} cannot fully charge, causing voltage errors. To minimize these errors an input bypass capacitor, C_S , should be used. Charge is shared between C_{IN} and C_S , causing a voltage error. The magnitude of this error is $\Delta V = V_{IN} \times C_{IN} / (C_{IN} + C_S)$. This error can be made arbitrarily small by increasing C_S .

The averaging effect of the bypass capacitor C_S causes another error term. Each time the input switches cycle between the plus and minus inputs, C_{IN} is charged and discharged. The average input current due to this is $I_{AVG} = V_{IN} \times C_{IN} \times f_S$, where f_S is the sampling frequency. Because the input current is directly proportional to the differential input voltage, the LTC1042 can be said to have an average input resistance of $R_{IN} = V_{IN} / I_{AVG} = 1 / (f_S \times C_{IN})$.

Since two comparator inputs are connected in parallel, R_{IN} is one half this value (see typical curve of R_{IN} vs Sampling Frequency). This finite input resistance causes an error due to voltage divider between R_S and R_{IN} .

The input error caused by both of these effects is $V_{ERROR} = V_{IN} [2C_{IN} / (2C_{IN} + C_S) + R_S / (R_S + R_{IN})]$.

EXAMPLE: Assume $f_S = 10\text{Hz}$, $R_S = 1M\Omega$, $C_S = 1\mu\text{F}$ and $V_{IN} = 1\text{V}$. Then $V_{ERROR} = 1\text{V}(66\mu\text{V} + 660\mu\text{V}) = 726\mu\text{V}$. If the sampling frequency is reduced to 1Hz , the voltage error from input impedance effects is reduced to $136\mu\text{V}$.

Input Voltage Range

The input switches of the LTC1042 are capable of switching either to the V^+ supply or ground. Consequently, the input voltage range includes both supply rails. This is a further benefit of the input sampling structure.

Error Specifications

The only measurable errors on the LTC1042 are the deviations from "ideal" of the upper and lower window limits [Figure 1(B)]. The critical parameters for a window comparator are the width and center of the window. These errors may be expressed in terms of V_U and V_L .

$$\text{center error} = [(V_U + V_L) / 2] - \text{CENTER}$$

$$\text{width error} = (V_U - V_L) - 2 \times (\text{WIDTH} / 2)$$

The specified error limits (see Electrical Characteristics) include error due to offset, power supply variation, gain, time and temperature.

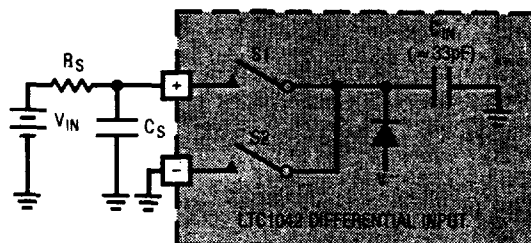
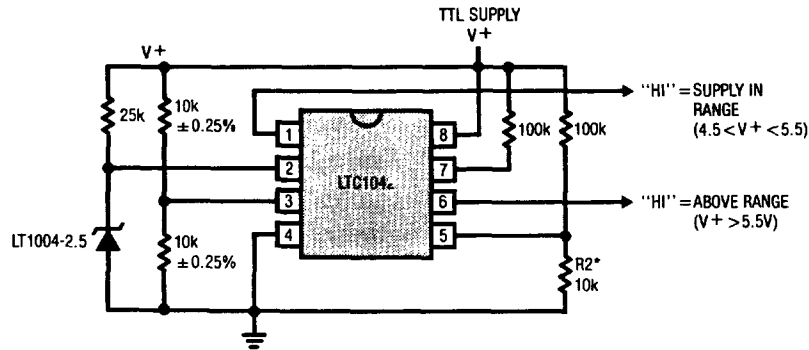

Figure 2. Equivalent Input Circuit

APPLICATIONS INFORMATION

TTL Power Supply Monitor



ALL RESISTORS $\pm 5\%$ UNLESS OTHERWISE NOTED.
 *SUPPLY TOLERANCE EQUALS R2 IN k Ω . I.E., 10k = $\pm 10\%$.

Single 5V Thermocouple Over Temperature Alarm

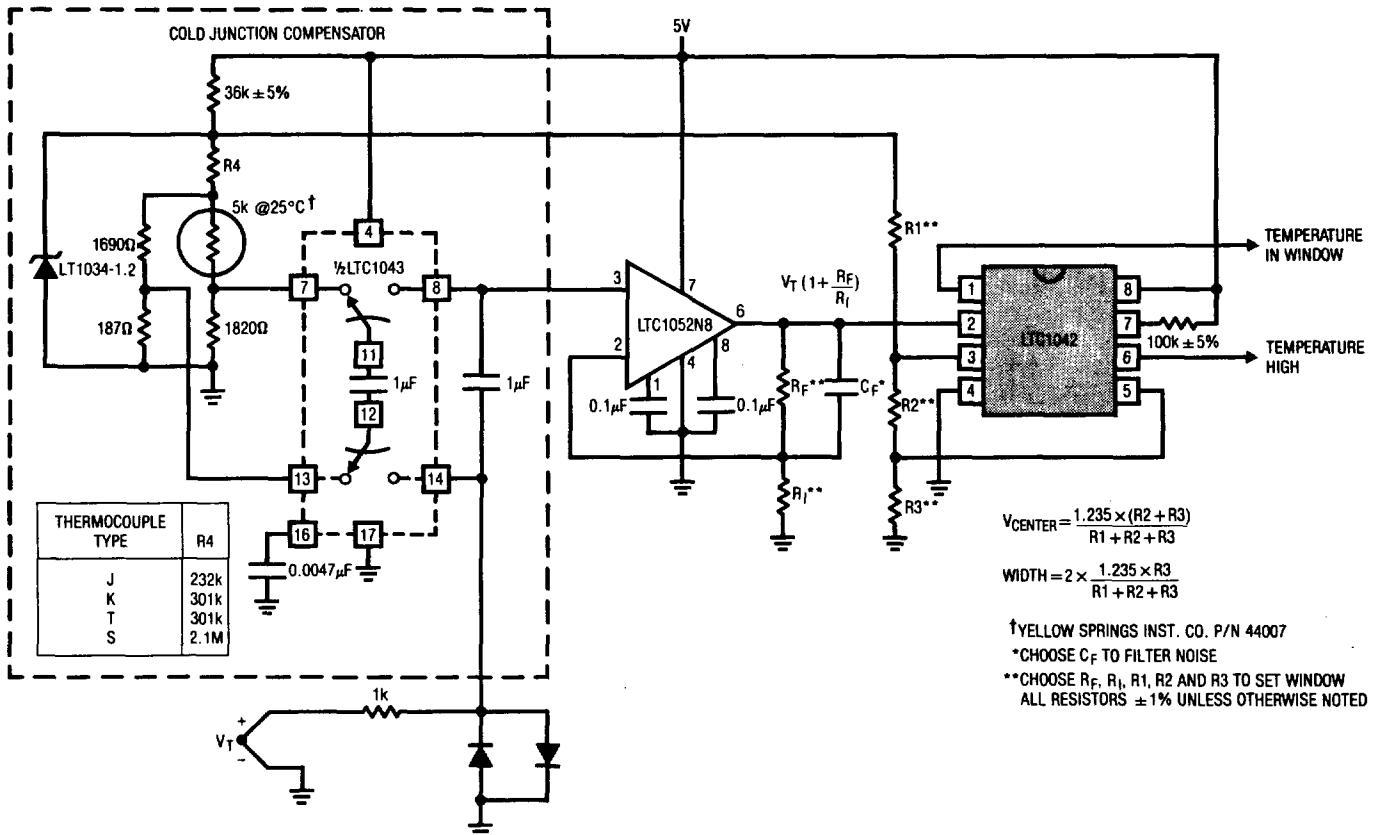

APPLICATIONS INFORMATION

Wind Powered Battery Charger

A simple wind powered battery charger can be constructed using the new LTC1042, a 12V DC permanent magnet motor, and low cost power FET transistor.

The DC motor is used as a generator with the voltage output being proportional to its RPM. The LTC1042 monitors the voltage output and provides the following control functions.

- 1) If generator voltage output is below 13.8V, the control circuit is active and the NiCad battery is charging through the LM334 current source. The lead acid battery is not being charged.
- 2) If the generator voltage output is between 13.8V and 15.1V, the 12V lead acid battery is being charged at about a 1 amp/hour rate (limited by the power FET).
- 3) If generator voltage exceeds 15.1V (a condition caused by excessive wind speed or 12V battery being fully charged) then a fixed load is connected thus limiting the generator RPM to prevent damage.

This charger can be used as a remote source of power where wind energy is plentiful such as on sailboats or remote radio repeater sites. Unlike solar powered panels, this system will function in bad weather and at night.

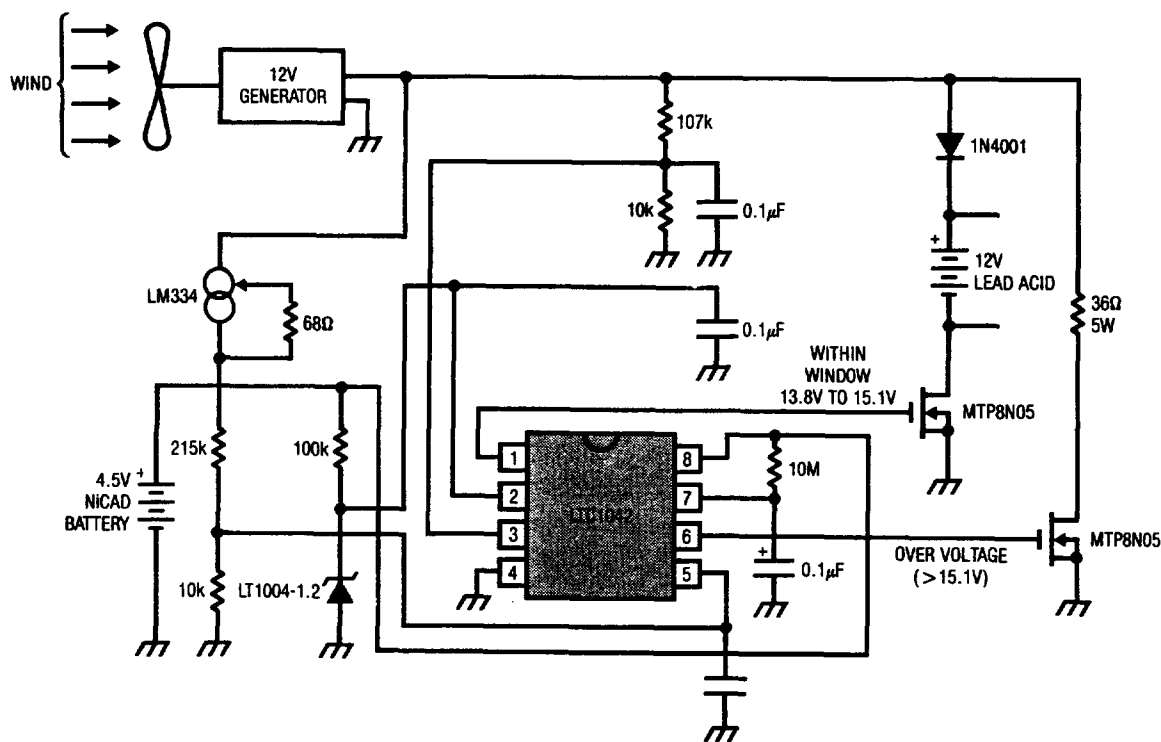

PACKAGE DESCRIPTION Dimensions in inches (millimeters) unless otherwise noted.

**J8 Package
8 Lead Hermetic DIP**

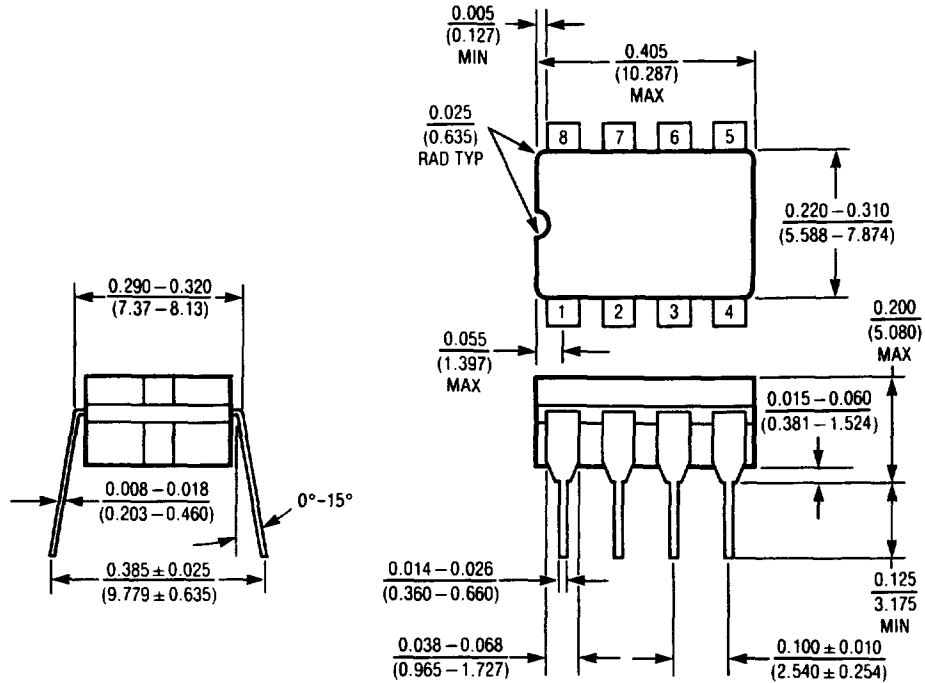

J8188

T_{jmax} 150°C	θ_{JA} 100°C/W
---------------------	--------------------------

**N8 Package
8 Lead Plastic**

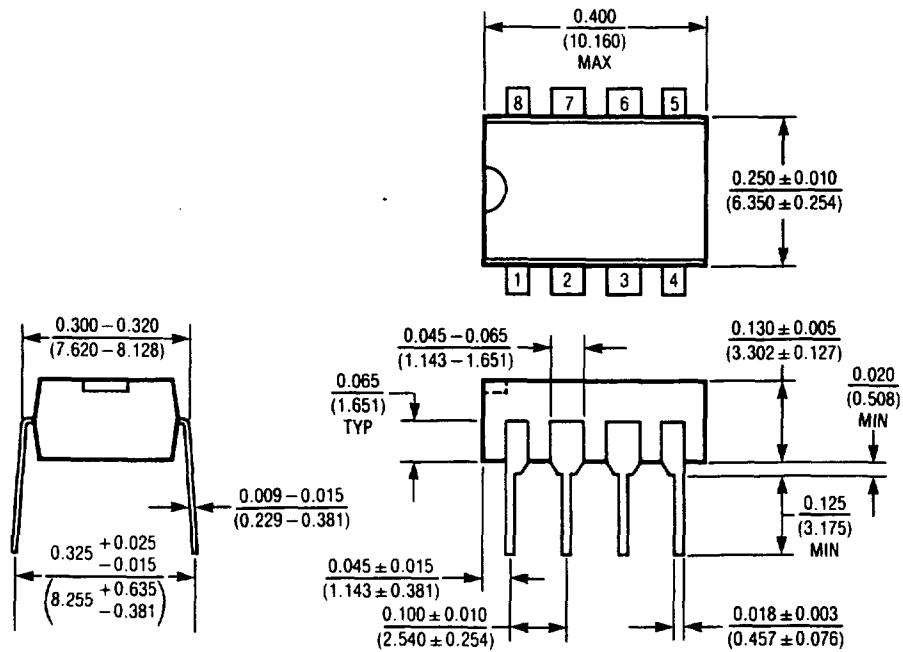

N8188

T_{jmax} 110°C	θ_{JA} 150°C/W
---------------------	--------------------------