

FEATURES

- **Sample Rate: 65Msps/40Msps**
- **79dB SNR and 100dB SFDR (2.25V_{p-p} Range)**
- **SFDR >92dB at 140MHz (1.5V_{p-p} Input Range)**
- **PGA Front End (2.25V_{p-p} or 1.5V_{p-p} Input Range)**
- **700MHz Full Power Bandwidth S/H**
- **Optional Internal Dither**
- **Optional Data Output Randomizer**
- Single 3.3V Supply
- Power Dissipation: 610mW/480mW
- Optional Clock Duty Cycle Stabilizer
- Out-of-Range Indicator
- Pin Compatible Family
 - 105Msps: LTC2207 (16-Bit), LTC2207-14 (14-Bit)
 - 80Msps: LTC2206 (16-Bit), LTC2206-14 (14-Bit)
 - 65Msps: LTC2205 (16-Bit), LTC2205-14 (14-Bit)
 - 40Msps: LTC2204 (16-Bit)
- 48-Pin (7mm × 7mm) QFN Package

APPLICATIONS

- Telecommunications
- Receivers
- Cellular Base Stations
- Spectrum Analysis
- Imaging Systems
- ATE

DESCRIPTION

The LTC[®]2205/LTC2204 are sampling 16-bit A/D converters designed for digitizing high frequency, wide dynamic range signals up to input frequencies of 700MHz. The input range of the ADC can be optimized with the PGA front end.

The LTC2205/LTC2204 are perfect for demanding communications applications, with AC performance that includes 79dB SNR and 100dB spurious free dynamic range (SFDR). Ultralow jitter of 90fs_{RMS} allows undersampling of high input frequencies with excellent noise performance. Maximum DC specs include ±4LSB INL, ±1LSB DNL (no missing codes).

A separate output power supply allows the CMOS output swing to range from 0.5V to 3.6V.

The ENC⁺ and ENC⁻ inputs may be driven differentially or single-ended with a sine wave, PECL, LVDS, TTL or CMOS inputs. An optional clock duty cycle stabilizer allows high performance at full speed with a wide range of clock duty cycles.

LT, *LT*, *LTC* and *LTM* are registered trademarks of Linear Technology Corporation. All other trademarks are the property of their respective owners.

TYPICAL APPLICATION

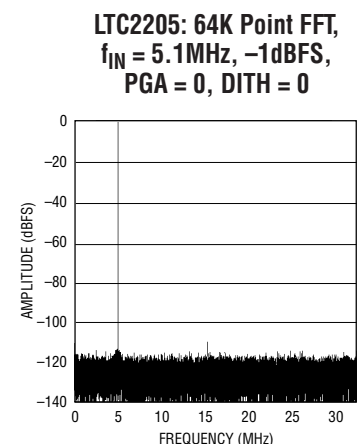
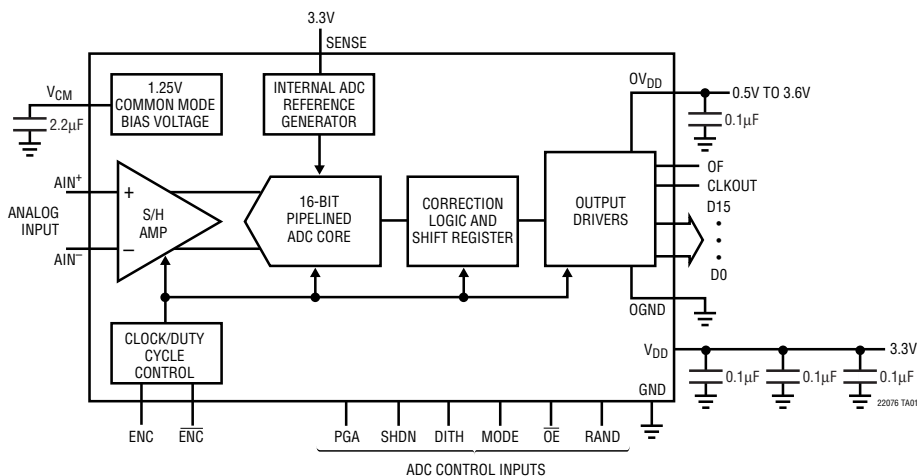

LTC2205/LTC2204

ABSOLUTE MAXIMUM RATINGS

$OV_{DD} = V_{DD}$ (Notes 1 and 2)

Supply Voltage (V_{DD})	-0.3V to 4V
Digital Output Ground Voltage (OGND)	-0.3V to 1V
Analog Input Voltage (Note 3)	-0.3V to ($V_{DD} + 0.3V$)
Digital Input Voltage	-0.3V to ($V_{DD} + 0.3V$)
Digital Output Voltage	-0.3V to ($OV_{DD} + 0.3V$)
Power Dissipation	2000mW
Operating Temperature Range	
LTC2205C/LTC2204C	0°C to 70°C
LTC2205I/LTC2204I	-40°C to 85°C
Storage Temperature Range	-65°C to 150°C
Digital Output Supply Voltage (OV_{DD})	-0.3V to 4V

PIN CONFIGURATION

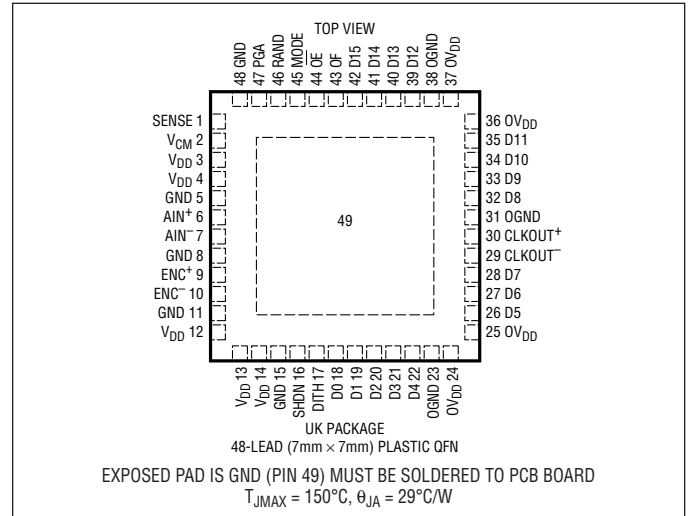

ORDER INFORMATION

LEAD FREE FINISH	TAPE AND REEL	PART MARKING*	PACKAGE DESCRIPTION	TEMPERATURE RANGE
LTC2205CUK#PBF	LTC2205CUK#TRPBF	LTC2205UK	48-Lead (7mm x 7mm) Plastic DFN	0°C to 70°C
LTC2204CUK#PBF	LTC2204CUK#TRPBF	LTC2204UK	48-Lead (7mm x 7mm) Plastic DFN	0°C to 70°C
LTC2205IUK#PBF	LTC2205IUK#TRPBF	LTC2205UK	48-Lead (7mm x 7mm) Plastic DFN	-40°C to 85°C
LTC2204IUK#PBF	LTC2204IUK#TRPBF	LTC2204UK	48-Lead (7mm x 7mm) Plastic DFN	-40°C to 85°C
LEAD BASED FINISH	TAPE AND REEL	PART MARKING*	PACKAGE DESCRIPTION	TEMPERATURE RANGE
LTC2205CUK	LTC2205CUK#TR	LTC2205UK	48-Lead (7mm x 7mm) Plastic DFN	0°C to 70°C
LTC2204CUK	LTC2204CUK#TR	LTC2204UK	48-Lead (7mm x 7mm) Plastic DFN	0°C to 70°C
LTC2205IUK	LTC2205IUK#TR	LTC2205UK	48-Lead (7mm x 7mm) Plastic DFN	-40°C to 85°C
LTC2204IUK	LTC2204IUK#TR	LTC2204UK	48-Lead (7mm x 7mm) Plastic DFN	-40°C to 85°C

Consult LTC Marketing for parts specified with wider operating temperature ranges. *The temperature grade is identified by a label on the shipping container.

For more information on lead free part marking, go to: <http://www.linear.com/leadfree/>

For more information on tape and reel specifications, go to: <http://www.linear.com/tapeand reel/>

CONVERTER CHARACTERISTICS

The ● denotes the specifications which apply over the full operating temperature range, otherwise specifications are at $T_A = 25^\circ\text{C}$. (Note 4)

PARAMETER	CONDITIONS	MIN	TYP	MAX	UNITS
Resolution (No Missing Codes)		●	16		Bits
Integral Linearity Error	Differential Analog Input (Note 5)	●	±0.7	±4.5	LSB
Integral Linearity Error	Differential Analog Input (Note 5), $T_A = 25^\circ\text{C}$		±0.7	±4	LSB
Differential Linearity Error	Differential Analog Input	●	±0.3	±1	LSB
Offset Error	(Note 6)	●	±1	±8.5	mV
Offset Drift			±10		$\mu\text{V}/^\circ\text{C}$
Gain Error	External Reference	●	±0.2	±1.9	%FS
Full-Scale Drift	Internal Reference		±30		ppm/ $^\circ\text{C}$
	External Reference		±10		ppm/ $^\circ\text{C}$
Transition Noise			2.5		LSB_{RMS}

22054fb

ANALOG INPUT

The ● denotes the specifications which apply over the full operating temperature range, otherwise specifications are at $T_A = 25^\circ\text{C}$. (Note 4)

SYMBOL	PARAMETER	CONDITIONS	MIN	TYP	MAX	UNITS	
V_{IN}	Analog Input Range ($A_{IN^+} - A_{IN^-}$)	$3.135V \leq V_{DD} \leq 3.465V$	●	1.5 to 2.25		V_{P-P}	
$V_{IN, CM}$	Analog Input Common Mode	Differential Input (Note 7)	●	1	1.25	1.5	V
I_{IN}	Analog Input Leakage Current	$0V \leq A_{IN^+}, A_{IN^-} \leq V_{DD}$	●	-1		1	μA
I_{SENSE}	SENSE Input Leakage Current	$0V \leq SENSE \leq V_{DD}$	●	-3		3	μA
I_{MODE}	MODE Pin Pull-Down Current to GND			10			μA
C_{IN}	Analog Input Capacitance	Sample Mode $ENC^+ < ENC^-$ Hold Mode $ENC^+ > ENC^-$		6.5			pF
				1.8			pF
t_{AP}	Sample-and-Hold Aperture Delay Time			0.7			ns
t_{JITTER}	Sample-and-Hold Aperture Delay Time Jitter			90			fs _{RMS}
CMRR	Analog Input Common Mode Rejection Ratio	$1V < (A_{IN^+} = A_{IN^-}) < 1.5V$		60			dB
BW-3dB	Full Power Bandwidth			700			MHz

DYNAMIC ACCURACY

The ● denotes the specifications which apply over the full operating temperature range, otherwise specifications are at $T_A = 25^\circ\text{C}$. $A_{IN} = -1\text{dBFS}$. (Note 4)

SYMBOL	PARAMETER	CONDITIONS	LTC2204			LTC2205			UNITS
			MIN	TYP	MAX	MIN	TYP	MAX	
SNR	Signal-to-Noise Ratio	5MHz Input (2.25V Range, PGA = 0)		79.1		79.0		dBFS	
		5MHz Input (1.5V Range, PGA = 1)		76.5		76.4		dBFS	
		15MHz Input (2.25V Range, PGA = 0)	●	77.6	79.0	77.5	78.9	dBFS	
		15MHz Input (2.25V Range, PGA = 0)		78	79.0	77.9	78.9	dBFS	
		15MHz Input (1.5V Range, PGA = 1)			76.5		76.4	dBFS	
		70MHz Input (2.25V Range, PGA = 0)			78.5		78.4	dBFS	
		70MHz Input (1.5V Range, PGA = 1)	●	74.6	76.3	74.6	76.2	dBFS	
		70MHz Input (1.5V Range, PGA = 1)		75		75		dBFS	
		140MHz Input (2.25V Range, PGA = 0)			77.4		77.3	dBFS	
		140MHz Input (1.5V Range, PGA = 1)			75.5		75.4	dBFS	
SFDR	Spurious Free Dynamic Range 2 nd or 3 rd Harmonic	5MHz Input (2.25V Range, PGA = 0)		100		100		dB	
		5MHz Input (1.5V Range, PGA = 1)		100		100		dB	
		15MHz Input (2.25V Range, PGA = 0)	●	87	100	87	100	dB	
		15MHz Input (2.25V Range, PGA = 0)		88	100	88	100	dB	
		15MHz Input (1.5V Range, PGA = 1)			100		100	dB	
		70MHz Input (2.25V Range, PGA = 0)			92		92	dB	
		70MHz Input (1.5V Range, PGA = 1)	●	84.5	94	84.5	94	dB	
		70MHz Input (1.5V Range, PGA = 1)		86	94	86	94	dB	
		140MHz Input (2.25V Range, PGA = 0)			89		89	dB	
		140MHz Input (1.5V Range, PGA = 1)			92		92	dB	
170MHz Input (2.25V Range, PGA = 0)			82		82		dB		
	170MHz Input (1.5V Range, PGA = 1)		84		84		dB		

DYNAMIC ACCURACY

The ● denotes the specifications which apply over the full operating temperature range, otherwise specifications are at $T_A = 25^\circ\text{C}$. $A_{IN} = -1\text{dBFS}$ unless otherwise noted. (Note 4)

SYMBOL	PARAMETER	CONDITIONS	LTC2204			LTC2205			UNITS
			MIN	TYP	MAX	MIN	TYP	MAX	
SFDR	Spurious Free Dynamic Range 4 th Harmonic or Higher	5MHz Input (2.25V Range, PGA = 0)		105		105		dB	
		5MHz Input (1.5V Range, PGA = 1)		105		105		dB	
		15MHz Input (2.25V Range, PGA = 0)	●	90	100	90	100	dB	
		15MHz Input (1.5V Range, PGA = 1)			100		100	dB	
		70MHz Input (2.25V Range, PGA = 0)			100		100	dB	
		70MHz Input (1.5V Range, PGA = 1)	●	88.5	100	88.5	100	dB	
S/(N+D)	Signal-to-Noise Plus Distortion Ratio	5MHz Input (2.25V Range, PGA = 0)		79.1		79.0		dBFS	
		5MHz Input (1.5V Range, PGA = 1)		76.5		76.4		dBFS	
		15MHz Input (2.25V Range, PGA = 0)	●	77.5	79.0	77.4	78.9	dBFS	
		15MHz Input (2.25V Range, PGA = 0)		77.7	79.0	77.6	78.9	dBFS	
		15MHz Input (1.5V Range, PGA = 1)			76.5		76.4	dBFS	
		70MHz Input (2.25V Range, PGA = 0)			78.5		78.4	dBFS	
SFDR	Spurious Free Dynamic Range at -25dBFS Dither "OFF"	5MHz Input (2.25V Range, PGA = 0)		105		105		dBFS	
		5MHz Input (1.5V Range, PGA = 1)		105		105		dBFS	
		15MHz Input (2.25V Range, PGA = 0)		105		105		dBFS	
		15MHz Input (1.5V Range, PGA = 1)		105		105		dBFS	
		70MHz Input (2.25V Range, PGA = 0)		105		105		dBFS	
		70MHz Input (1.5V Range, PGA = 1)		105		105		dBFS	
SFDR	Spurious Free Dynamic Range at -25dBFS Dither "ON"	5MHz Input (2.25V Range, PGA = 0)		115		115		dBFS	
		5MHz Input (1.5V Range, PGA = 1)		115		115		dBFS	
		15MHz Input (2.25V Range, PGA = 0)	●	98	115	98	115	dBFS	
		15MHz Input (1.5V Range, PGA = 1)			115		115	dBFS	
		70MHz Input (2.25V Range, PGA = 0)			115		115	dBFS	
		70MHz Input (1.5V Range, PGA = 1)			115		115	dBFS	
SFDR	Spurious Free Dynamic Range at -25dBFS Dither "ON"	140MHz Input (2.25V Range, PGA = 0)		115		115		dBFS	
		140MHz Input (1.5V Range, PGA = 1)		115		115		dBFS	
		170MHz Input (2.25V Range, PGA = 0)		105		105		dBFS	
		170MHz Input (1.5V Range, PGA = 1)		105		105		dBFS	
		170MHz Input (2.25V Range, PGA = 0)		105		105		dBFS	
		170MHz Input (1.5V Range, PGA = 1)		105		105		dBFS	

COMMON MODE BIAS CHARACTERISTICS

The ● denotes the specifications which apply over the full operating temperature range, otherwise specifications are at $T_A = 25^\circ\text{C}$. (Note 4)

PARAMETER	CONDITIONS	MIN	TYP	MAX	UNITS
V_{CM} Output Voltage	$I_{OUT} = 0$	1.15	1.25	1.35	V
V_{CM} Output Tempco	$I_{OUT} = 0$		±40		ppm/ $^\circ\text{C}$
V_{CM} Line Regulation	$3.135\text{V} \leq V_{DD} \leq 3.465\text{V}$		1		mV/V
V_{CM} Output Resistance	$1\text{mA} \leq I_{OUT} \leq 1\text{mA}$		1		Ω

DIGITAL INPUTS AND DIGITAL OUTPUTS

The ● denotes the specifications which apply over the full operating temperature range, otherwise specifications are at $T_A = 25^\circ\text{C}$. (Note 4)

SYMBOL	PARAMETER	CONDITIONS	MIN	TYP	MAX	UNITS	
ENCODE INPUTS (ENC⁺, ENC⁻)							
V_{ID}	Differential Input Voltage (Note 7)		●	0.2		V	
V_{ICM}	Common Mode Input Voltage	Internally Set Externally Set (Note 7)		1.6	3.0	V V	
R_{IN}	Input Resistance	(See Figure 2)		6		k Ω	
C_{IN}	Input Capacitance	(Note 7)		3		pF	
LOGIC INPUTS (DITH, PGA, SHDN, RAND)							
V_{IH}	High Level Input Voltage	$V_{DD} = 3.3\text{V}$	●	2		V	
V_{IL}	Low Level Input Voltage	$V_{DD} = 3.3\text{V}$	●		0.8	V	
I_{IN}	Digital Input Current	$V_{IN} = 0\text{V}$ to V_{DD}	●		±10	μA	
C_{IN}	Digital Input Capacitance	(Note 7)		1.5		pF	
LOGIC OUTPUTS							
OV_{DD} = 3.3V							
V_{OH}	High Level Output Voltage	$V_{DD} = 3.3\text{V}$		3.299		V	
			$I_O = -10\mu\text{A}$ $I_O = -200\mu\text{A}$	●	3.1	3.29	V V
V_{OL}	Low Level Output Voltage	$V_{DD} = 3.3\text{V}$		0.01	0.4	V	
			$I_O = 160\mu\text{A}$ $I_O = 1.6\text{mA}$	●			V V
I_{SOURCE}	Output Source Current	$V_{OUT} = 0\text{V}$		-50		mA	
I_{SINK}	Output Sink Current	$V_{OUT} = 3.3\text{V}$		50		mA	
OV_{DD} = 2.5V							
V_{OH}	High Level Output Voltage	$V_{DD} = 3.3\text{V}$		2.49		V	
V_{OL}	Low Level Output Voltage	$V_{DD} = 3.3\text{V}$		0.1		V	
OV_{DD} = 1.8V							
V_{OH}	High Level Output Voltage	$V_{DD} = 3.3\text{V}$		1.79		V	
V_{OL}	Low Level Output Voltage	$V_{DD} = 3.3\text{V}$		0.1		V	

POWER REQUIREMENTS

The ● denotes the specifications which apply over the full operating temperature range, otherwise specifications are at $T_A = 25^\circ\text{C}$.

SYMBOL	PARAMETER	CONDITIONS	LTC2204			LTC2205			UNITS	
			MIN	TYP	MAX	MIN	TYP	MAX		
V_{DD}	Analog Supply Voltage		3.135	3.3	3.465	3.315	3.3	3.465	V	
P_{SHDN}	Shutdown Power	SHDN = V_{DD}		0.2			0.2		mW	
OV _{DD}	Output Supply Voltage		●	0.5V	3.6	●	0.5V	3.3	3.6	V
I_{VDD}	Analog Supply Current		●	145	200		185	235	mA	
P_{DIS}	Power Dissipation		●	480	660		610	776	mW	

22054fb

TIMING CHARACTERISTICS

The ● denotes the specifications which apply over the full operating temperature range, otherwise specifications are at $T_A = 25^\circ\text{C}$. (Note 4)

SYMBOL	PARAMETER	CONDITIONS	LTC2204			LTC2205			UNITS	
			MIN	TYP	MAX	MIN	TYP	MAX		
f_S	Sampling Frequency		●	1		40	1		65	MHz
t_L	ENC Low Time	Duty Cycle Stabilizer Off (Note 7)	●	10.4	12.5	500	6.40	7.69	500	ns
		Duty Cycle Stabilizer On (Note 7)	●	2.7	12.5	500	2.70	7.69	500	ns
t_H	ENC High Time	Duty Cycle Stabilizer Off (Note 7)	●	10.4	12.5	500	6.40	7.69	500	ns
		Duty Cycle Stabilizer On (Note 7)	●	2.7	12.5	500	2.70	7.69	500	ns
t_{AP}	Sample-and-Hold Aperture Delay				0.7			0.7		ns
t_D	ENC to DATA Delay	(Note 7)	●	1.3	2.7	4.0	1.3	2.7	4.0	ns
t_C	ENC to CLKOUT Delay	(Note 7)	●	1.3	2.7	4.0	1.3	2.7	4.0	ns
t_{SKEW}	DATA to CLKOUT Skew	$(t_D - t_C)$ (Note 7)	●	-0.6	0	0.6	-0.6	0	0.6	ns
t_{OE}	DATA Access Time Bus Relinquish Time	CL = 5pF (Note 7)	●		5	15		5	15	ns
		(Note 7)	●		5	15		5	15	ns
Pipeline Latency					7			7		Cycles

Note 1: Stresses beyond those listed under Absolute Maximum Ratings may cause permanent damage to the device. Exposure to any Absolute Maximum Rating condition for extended periods may affect device reliability and lifetime.

Note 2: All voltage values are with respect to GND, with GND and OGND shorted (unless otherwise noted).

Note 3: When these pin voltages are taken below GND or above V_{DD} , they will be clamped by internal diodes. This product can handle input currents of greater than 100mA below GND or above V_{DD} without latching.

Note 4: $V_{DD} = 3.3\text{V}$, $f_{SAMPLE} = 65\text{MHz}$ (LTC2205), 40MHz (LTC2204) differential ENC⁺/ENC⁻ = 2V_{P-P} sine wave with 1.6V common mode,

input range = 2.25V_{P-P} with differential drive (PGA = 0), unless otherwise specified.

Note 5: Integral nonlinearity is defined as the deviation of a code from a “best fit straight line” to the transfer curve. The deviation is measured from the center of the quantization band.

Note 6: Offset error is the offset voltage measured from -1/2LSB when the output code flickers between 0000 0000 0000 0000 and 1111 1111 1111 1111 in 2’s complement output mode.

Note 7: Guaranteed by design, not subject to test.

Note 8: Recommended operating conditions.

TIMING DIAGRAM

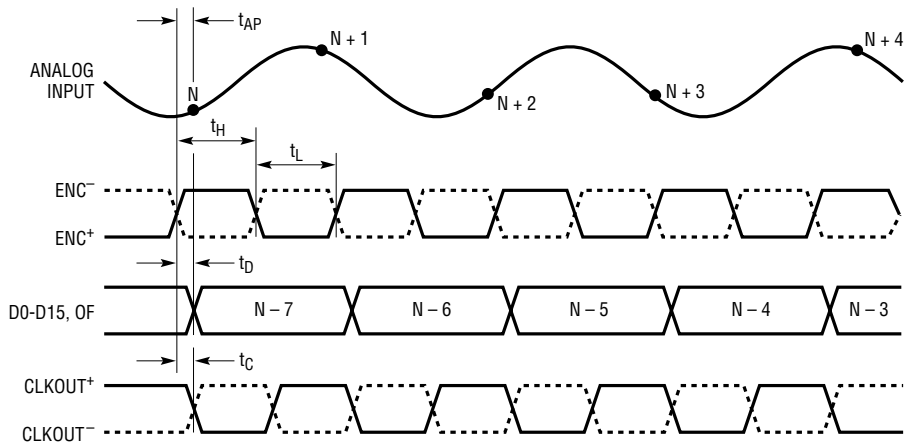

22054 TD01

TYPICAL PERFORMANCE CHARACTERISTICS

LTC2205: INL (Integral Non-Linearity) vs Code

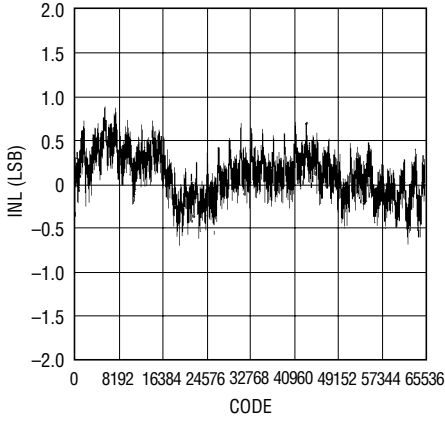

22054 G01

LTC2205: DNL (Differential Non-Linearity) vs Code

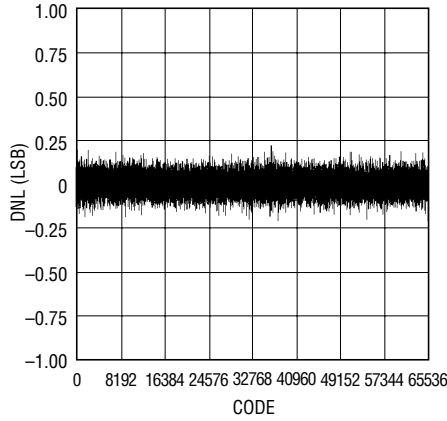

22054 G02

LTC2205: Grounded Input Histogram

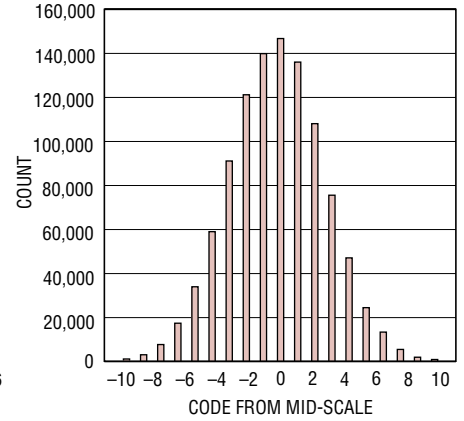

22054 G03

**LTC2205: 64K Point FFT,
 $f_{IN} = 5.1\text{MHz}$, -1dBFS ,
PGA = 0, DITH = 0**

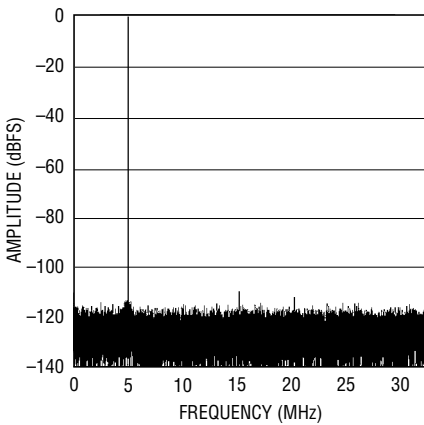

22054 G04

**LTC2205: 64K Point FFT,
65Mps, $f_{IN} = 5.1\text{MHz}$, -1dBFS ,
PGA = 1, DITH = 0**

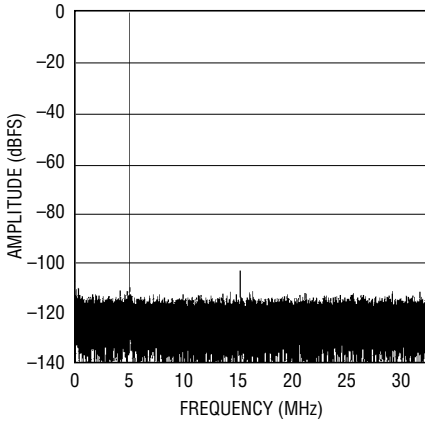

22054 G05

**LTC2205: 64K Point FFT,
 $f_{IN} = 5.1\text{MHz}$, -25dBFS ,
PGA = 0, DITH = 0**

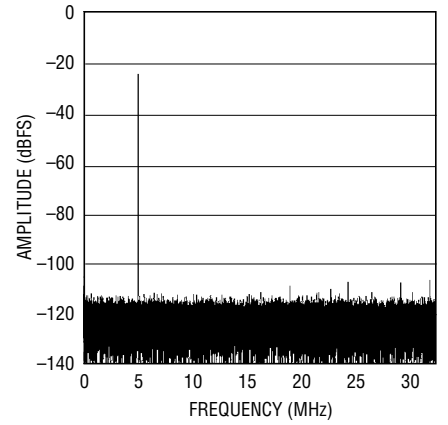

22054 G06

**LTC2205: 64K Point FFT,
 $f_{IN} = 5.1\text{MHz}$, -25dBFS ,
PGA = 0, DITH = 1**

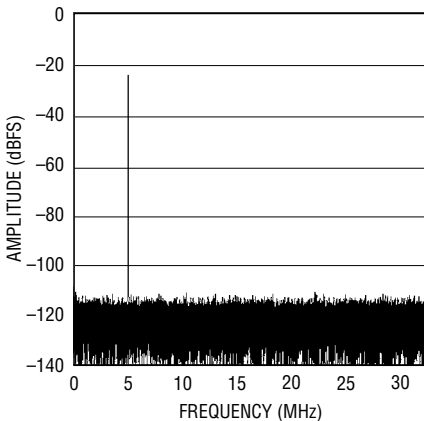

22054 G07

**LTC2205: 64K Point FFT,
 $f_{IN} = 5.1\text{MHz}$, -40dBFS ,
PGA = 0, DITH = 0**

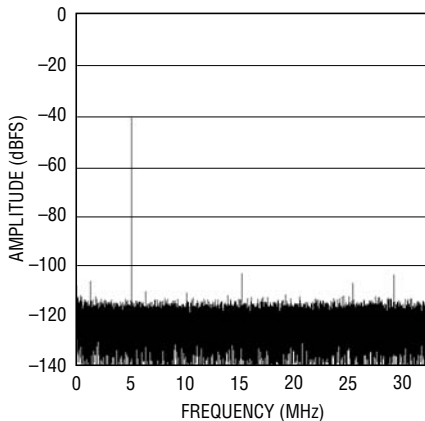

22054 G08

**LTC2205: 64K Point FFT,
 $f_{IN} = 5.1\text{MHz}$, -40dBFS ,
PGA = 0, DITH = 1**

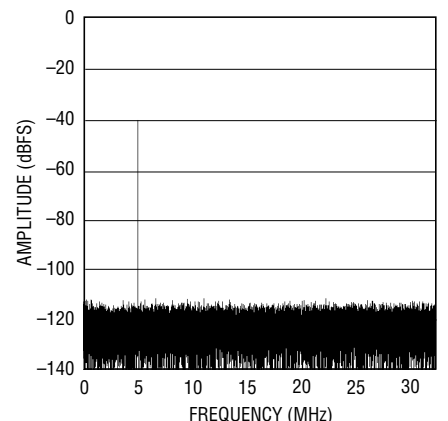

22054 G09

TYPICAL PERFORMANCE CHARACTERISTICS

**LTC2205: 64K Point FFT,
65Mps, $f_{IN} = 15.1\text{MHz}$, -1dBFS ,
PGA = 0, DITH = 0**

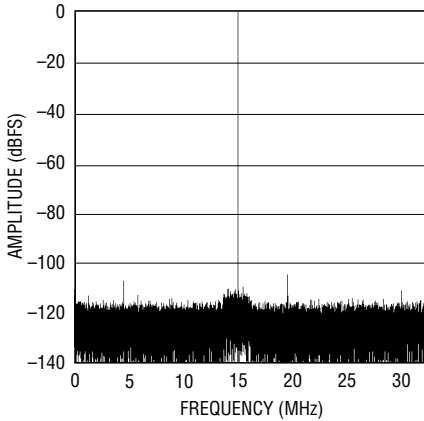

22054 G10

**LTC2205: 64K Point FFT,
65Mps, $f_{IN} = 15.1\text{MHz}$, -1dBFS ,
PGA = 1, DITH = 0**

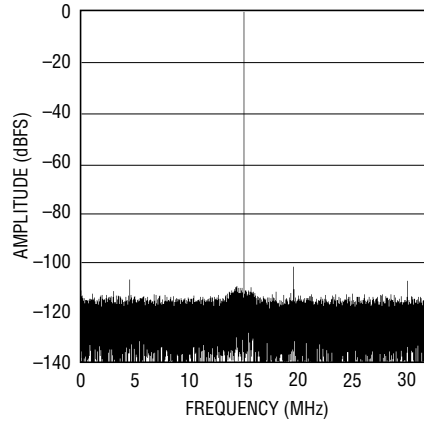

22054 G11

**LTC2205: 64K Point FFT,
65Mps, $f_{IN} = 15.1\text{MHz}$, -25dBFS ,
PGA = 0, DITH = 0**

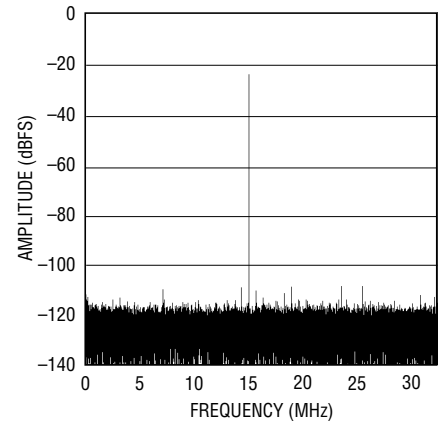

22054 G12

**LTC2205: 64K Point FFT,
65Mps, $f_{IN} = 15.1\text{MHz}$, -25dBFS ,
PGA = 0, DITH = 1**

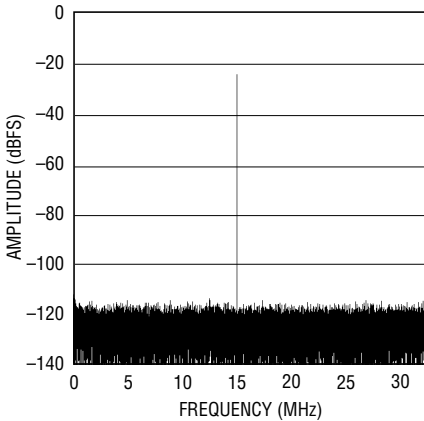

22054 G13

**LTC2205: 64K Point FFT,
65Mps, $f_{IN} = 15.1\text{MHz}$, -40dBFS ,
PGA = 0, DITH = 0**

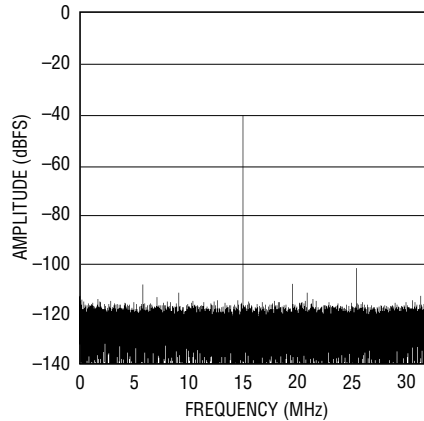

22054 G14

**LTC2205: 64K Point FFT,
65Mps, $f_{IN} = 15.1\text{MHz}$, -40dBFS ,
PGA = 0, DITH = 1**

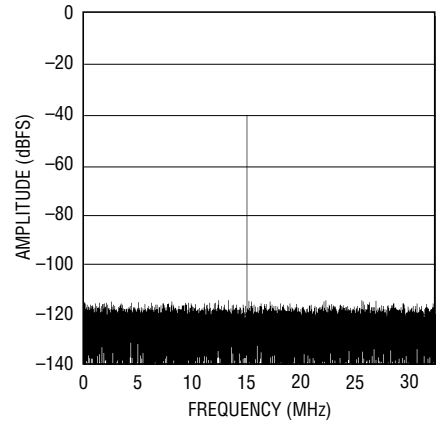

22054 G15

**LTC2205: 64K Point FFT,
65Mps, $f_{IN} = 70.1\text{MHz}$, -1dBFS ,
PGA = 0, DITH = 0**

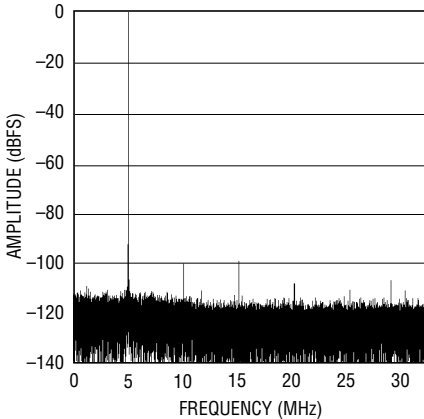

22054 G16

**LTC2205: 64K Point FFT,
65Mps, $f_{IN} = 70.1\text{MHz}$, -1dBFS ,
PGA = 1, DITH = 0**

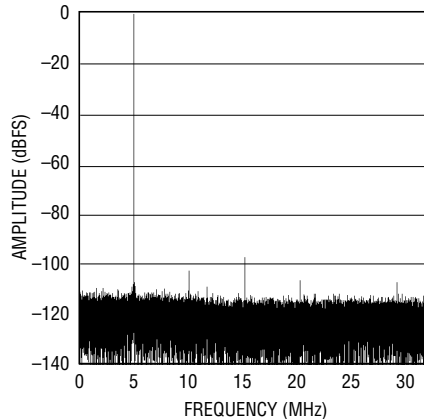

22054 G17

**LTC2205: 64K Point FFT,
65Mps, $f_{IN} = 70.1\text{MHz}$, -25dBFS ,
PGA = 0, DITH = 0**

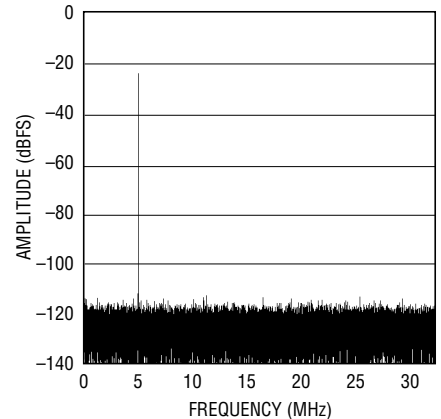

22054 G18
22054fb

TYPICAL PERFORMANCE CHARACTERISTICS

**LTC2205: 64K Point FFT,
65Msps, $f_{IN} = 70.1\text{MHz}$, -25dBFS ,
PGA = 0, DITH = 1**

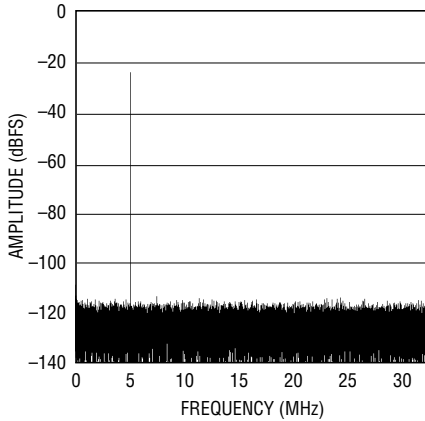

22054 G19

**LTC2205: 64K Point FFT,
65Msps, $f_{IN} = 70.1\text{MHz}$, -40dBFS ,
PGA = 0, DITH = 0**

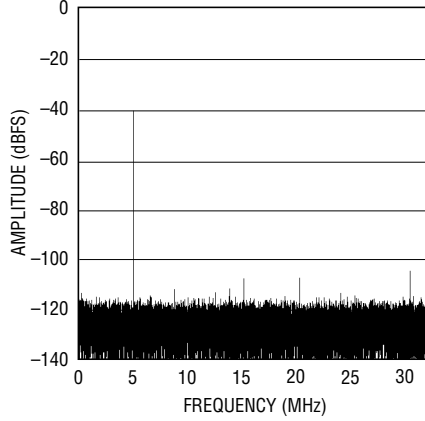

22054 G20

**LTC2205: 64K Point FFT,
65Msps, $f_{IN} = 70.1\text{MHz}$, -40dBFS ,
PGA = 0, DITH = 1**

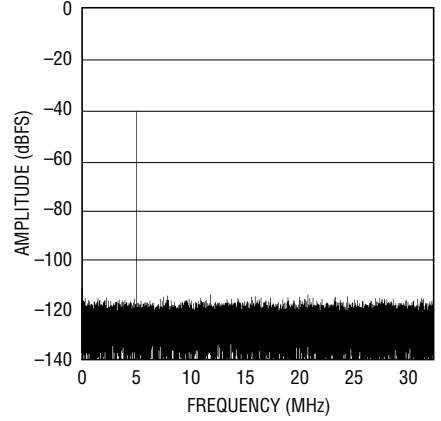

22054 G21

**LTC2205: 64K Point FFT,
65Msps, $f_{IN} = 140.1\text{MHz}$, -1dBFS ,
PGA = 0, DITH = 0**

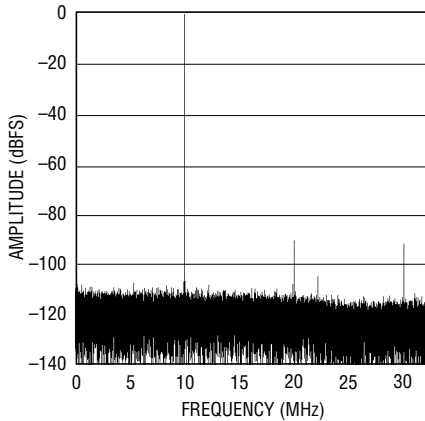

22054 G22

**LTC2205: 64K Point FFT,
 $f_{IN} = 140.1\text{MHz}$, -1dBFS ,
PGA = 1, DITH = 0**

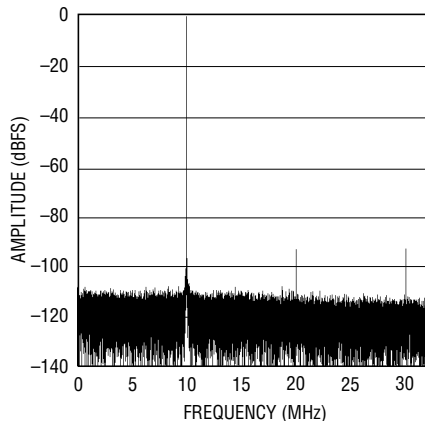

22054 G23

**LTC2205: 64K Point FFT,
65Msps, $f_{IN} = 140.1\text{MHz}$,
 -25dBFS , PGA = 0, DITH = 0**

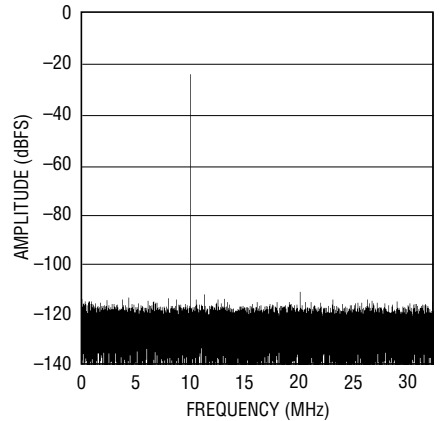

22054 G24

**LTC2205: 64K Point FFT,
65Msps, $f_{IN} = 140.1\text{MHz}$,
 -25dBFS , PGA = 0, DITH = 1**

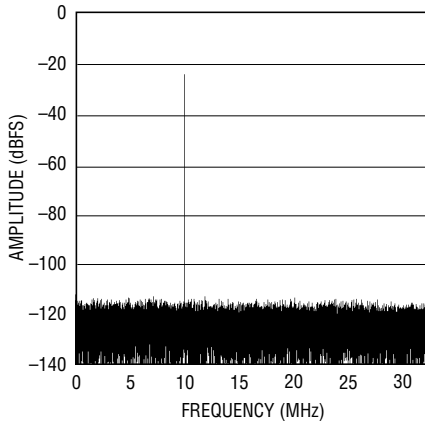

22054 G25

**LTC2205: 64K Point FFT,
65Msps, $f_{IN} = 140.1\text{MHz}$,
 -40dBFS , PGA = 0, DITH = 0**

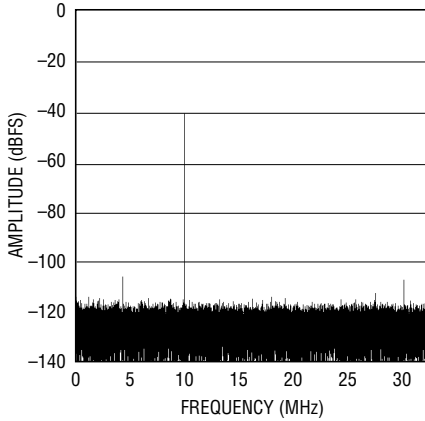

22054 G26

**LTC2205: 64K Point FFT,
65Msps, $f_{IN} = 140.1\text{MHz}$,
 -40dBFS , PGA = 0, DITH = 1**

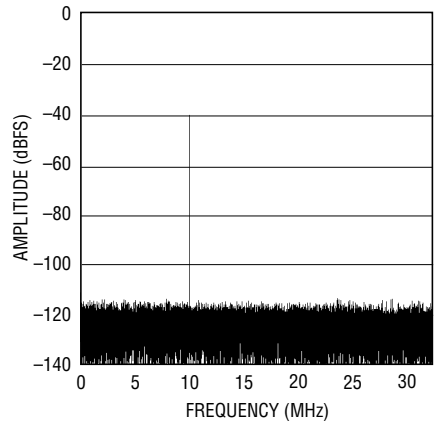

22054 G27

22054fb

TYPICAL PERFORMANCE CHARACTERISTICS

LTC2205: 64K Point FFT,
 $f_{IN1} = 14.9\text{MHz}$, -7dBFS ,
 $f_{IN2} = 20.1\text{MHz}$, -7dBFS , $\text{PGA} = 0$

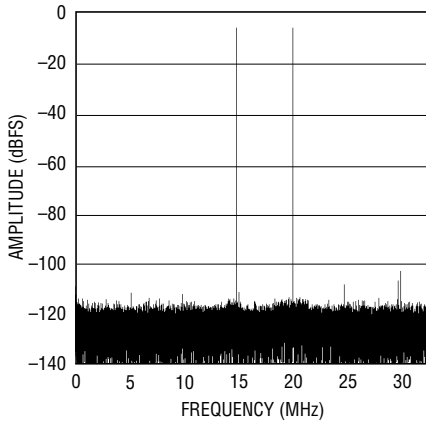

22054 G28

LTC2205: 64K Point FFT,
 $f_{IN1} = 64.1\text{MHz}$, -7dBFS ,
 $f_{IN2} = 20.1\text{MHz}$, -7dBFS , $\text{PGA} = 0$

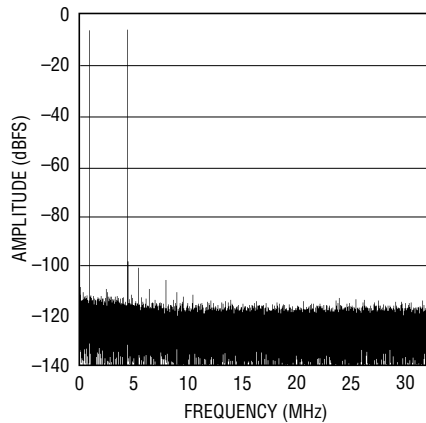

22054 G29

LTC2205: SFDR vs Input Level,
 $f_{IN} = 5.1\text{MHz}$,
 $\text{DITH} = 0$, $\text{RAND} = 1$, $\text{PGA} = 0$

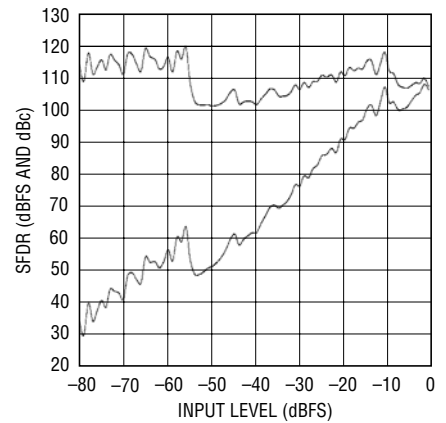

22054 G30

LTC2205: SFDR vs Input Level,
 $f_{IN} = 5.1\text{MHz}$,
 $\text{DITH} = 1$, $\text{RAND} = 1$, $\text{PGA} = 0$

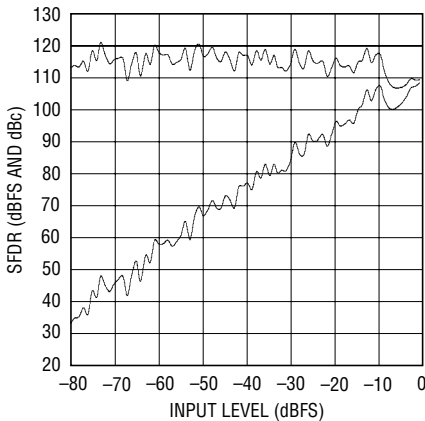

22054 G31

LTC2205: SFDR vs Input Level,
 $f_{IN} = 15.1\text{MHz}$,
 $\text{DITH} = 0$, $\text{RAND} = 1$, $\text{PGA} = 0$

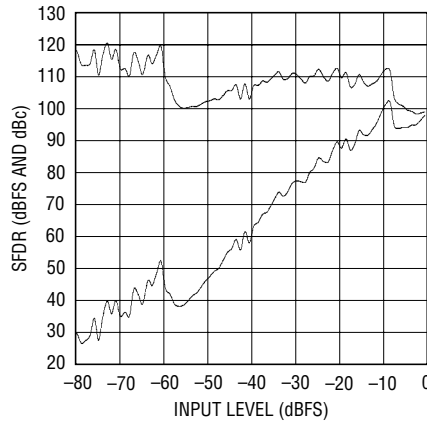

22054 G32

LTC2205: SFDR vs Input Level,
 $f_{IN} = 15.1\text{MHz}$,
 $\text{DITH} = 1$, $\text{RAND} = 1$, $\text{PGA} = 0$

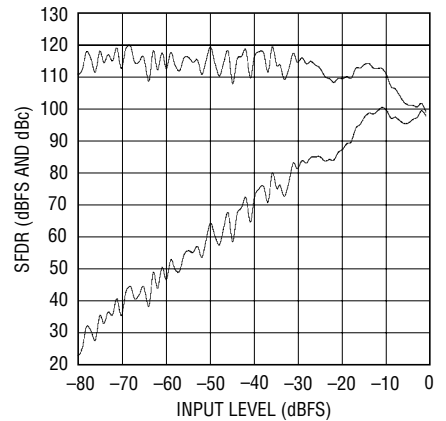

22054 G33

LTC2205: SFDR vs Input Level,
 $f_{IN} = 70.1\text{MHz}$,
 $\text{DITH} = 0$, $\text{RAND} = 1$, $\text{PGA} = 0$

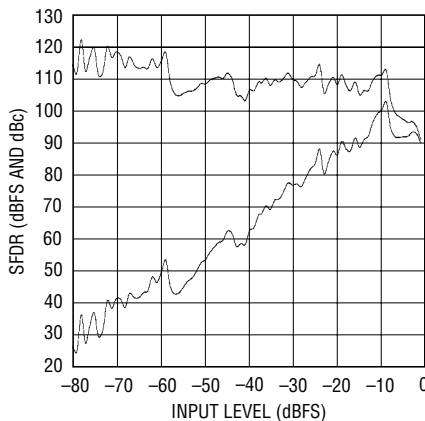

22054 G34

LTC2205: SFDR vs Input Level,
 $f_{IN} = 70.1\text{MHz}$,
 $\text{DITH} = 1$, $\text{RAND} = 1$, $\text{PGA} = 0$

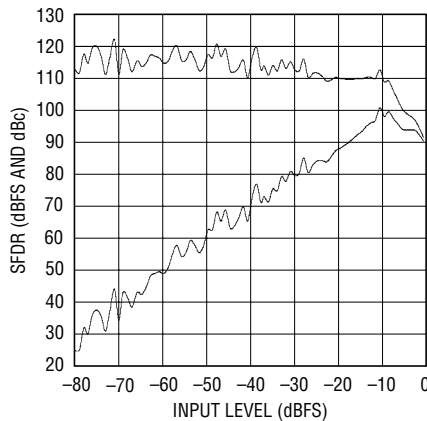

22054 G35

LTC2205: SFDR vs Input Level,
 $f_{IN} = 140.1\text{MHz}$,
 $\text{DITH} = 0$, $\text{RAND} = 1$, $\text{PGA} = 0$

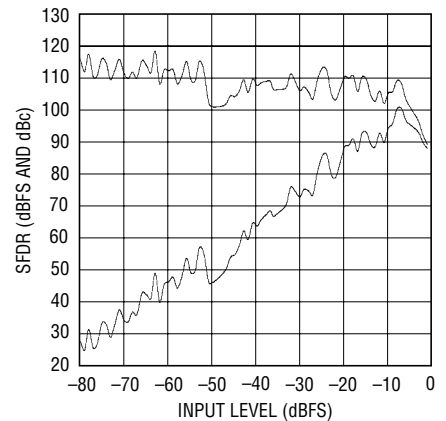

22054 G36

22054fb

TYPICAL PERFORMANCE CHARACTERISTICS

LTC2205: SFDR vs Input Level,
 $f_{IN} = 140.1\text{MHz}$,
 DITH = 1, RAND = 1, PGA = 0

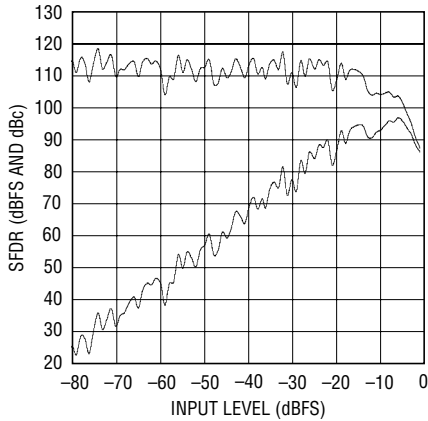

22054 G37

LTC2205: SFDR vs Input Frequency,
 DITH = 0, RAND = 0

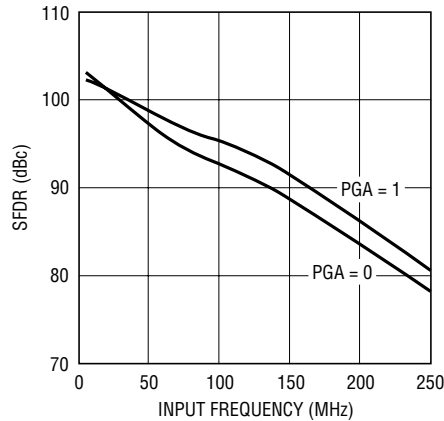

22054 G38

LTC2205: SNR vs Input Frequency,
 DITH = 0, RAND = 0

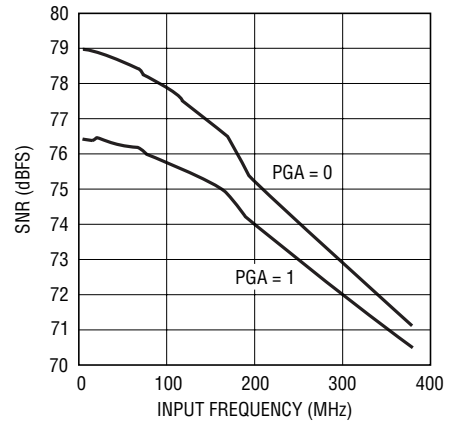

22054 G39

LTC2205: SFDR and SNR vs Sample Rate,
 $f_{IN} = 5.1\text{MHz}$,
 -1dBFS , PGA = 0

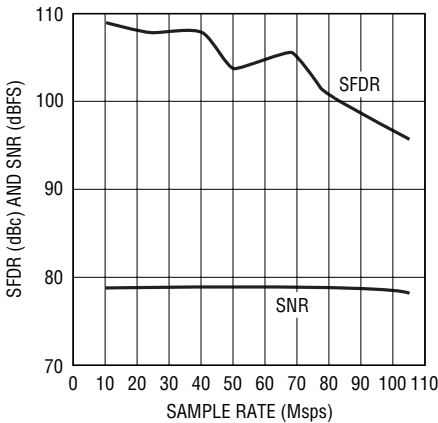

22054 G40

LTC2205: SFDR and SNR vs Supply Voltage,
 $f_{IN} = 5.1\text{MHz}$,
 65MSPS , PGA = 0

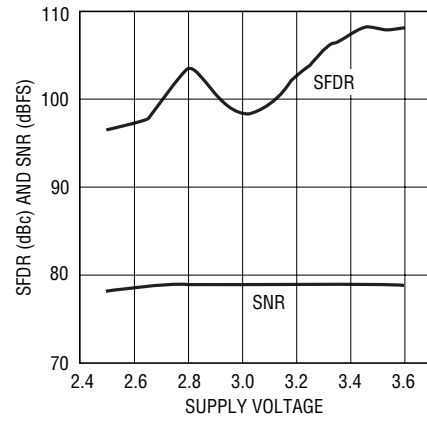

22054 G41

LTC2205: IVDD vs Sample Rate,
 $f_{IN} = 5.1\text{MHz}$, -1dBFS

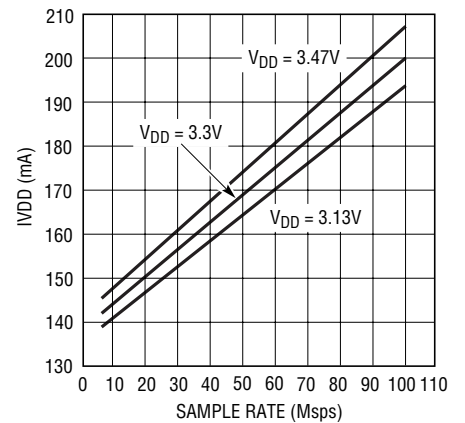

22054 G42

LTC2205: Gain Error Drift with Internal Reference vs Temperature

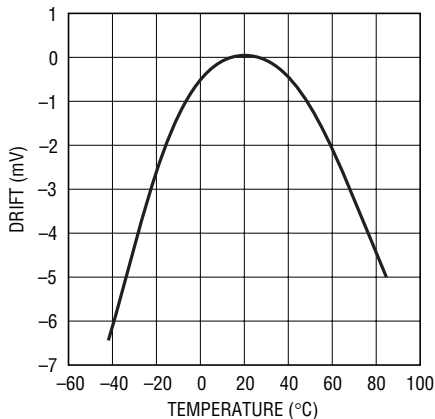

22054 G43

LTC2205: Gain Drift with External Reference vs Temperature

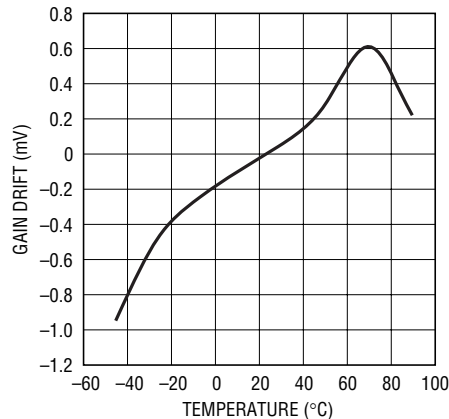

22054 G44

LTC2205: V_{CM} Drift vs Temperature

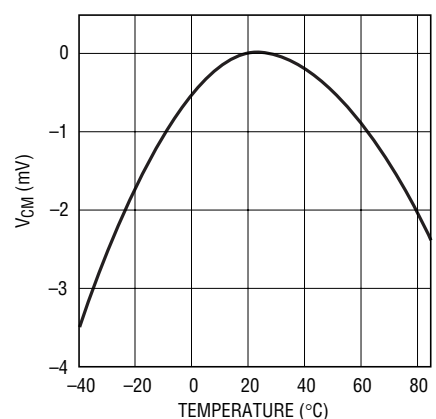

22054 G45
 22054fb

TYPICAL PERFORMANCE CHARACTERISTICS

LTC2205: SFDR and SNR vs Temperature, $f_{IN} = 5.1\text{MHz}$

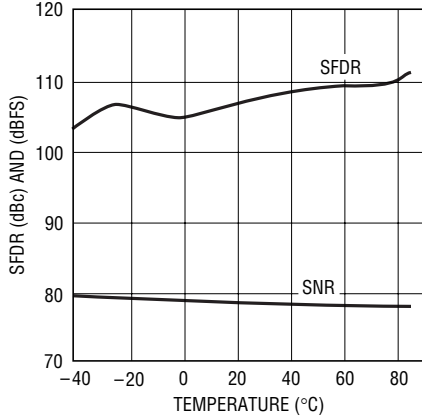

22054 G46

LTC2205: SFDR and SNR vs Input Common Mode Voltage, $f_{IN} = 5.1\text{MHz}$

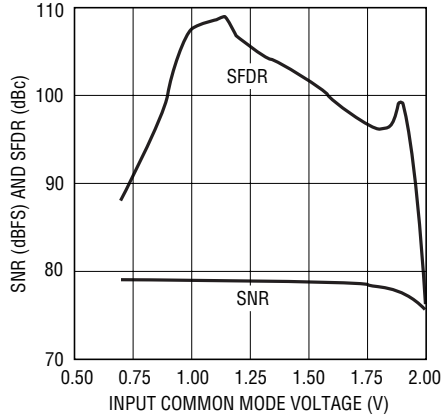

29701 G46b

LTC2204: 64K Point FFT, 40Msps, $f_{IN} = 5.1\text{MHz}$, -1dBFS, PGA = 0, DITH = 0

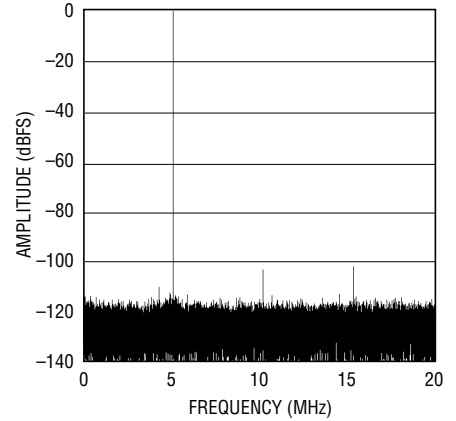

22054 G47

LTC2204: 64K Point FFT, 40Msps, $f_{IN} = 5.1\text{MHz}$, -1dBFS, PGA = 1, DITH = 0

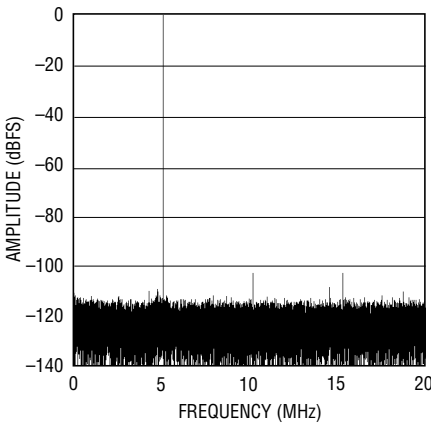

22054 G48

LTC2204: 64K Point FFT, 40Msps, $f_{IN} = 5.1\text{MHz}$, -25dBFS, PGA = 0, DITH = 0

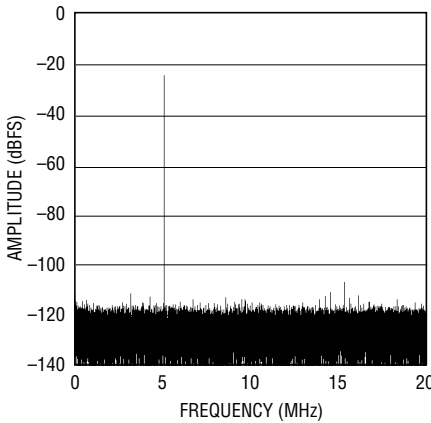

22054 G49

LTC2204: 64K Point FFT, 40Msps, $f_{IN} = 5.1\text{MHz}$, -25dBFS, PGA = 0, DITH = 1

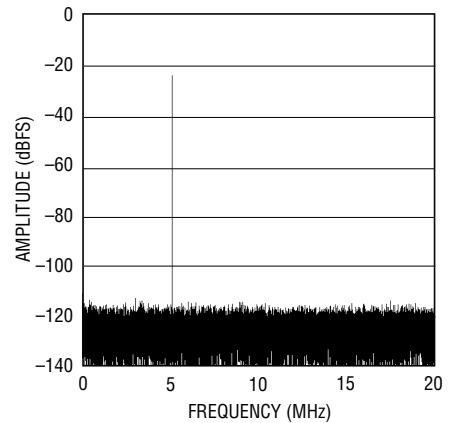

22054 G50

LTC2204: 64K Point FFT, 40Msps, $f_{IN} = 5.1\text{MHz}$, -40dBFS, PGA = 0, DITH = 0

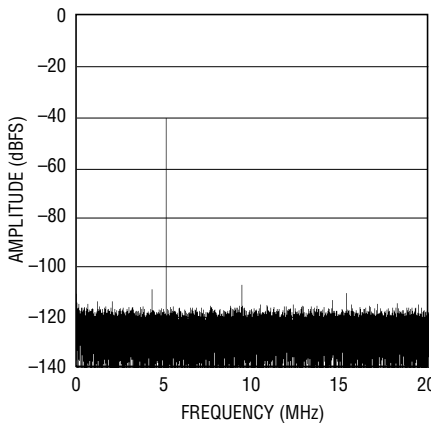

22054 G51

LTC2204: 64K Point FFT, 40Msps, $f_{IN} = 5.1\text{MHz}$, -40dBFS, PGA = 0, DITH = 1

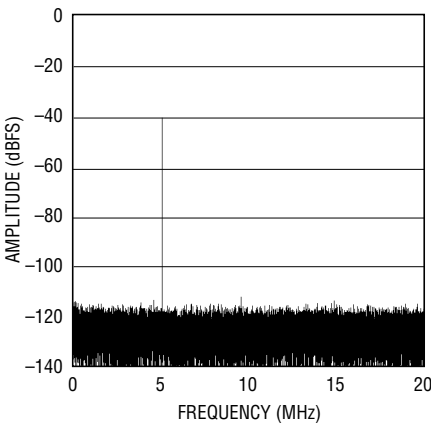

22054 G52

LTC2204: 64K Point FFT, 40Msps, $f_{IN} = 15.1\text{MHz}$, -1dBFS, PGA = 0, DITH = 0

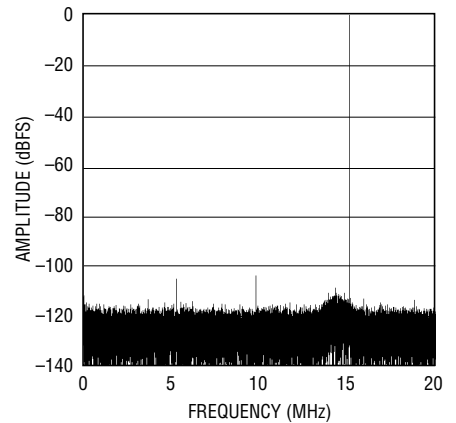

22054 G53

TYPICAL PERFORMANCE CHARACTERISTICS

**LTC2204: 64K Point FFT,
40Msps, $f_{IN} = 15.1\text{MHz}$, -1dBFS ,
PGA = 1, DITH = 0**

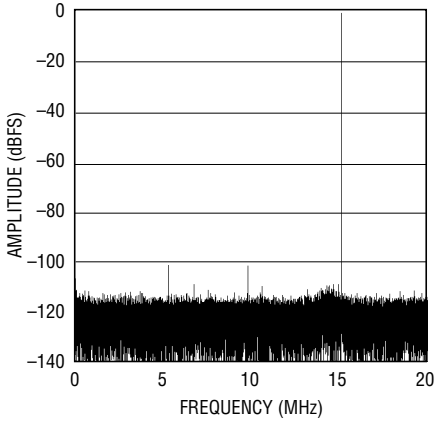

22054 G54

**LTC2204: 64K Point FFT,
40Msps, $f_{IN} = 15.1\text{MHz}$, -25dBFS ,
PGA = 0, DITH = 0**

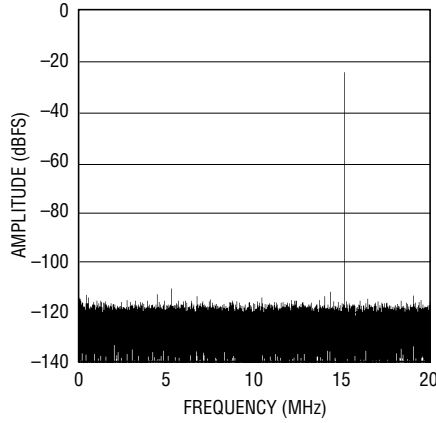

22054 G55

**LTC2204: 64K Point FFT,
40Msps, $f_{IN} = 15.1\text{MHz}$, -25dBFS ,
PGA = 0, DITH = 1**

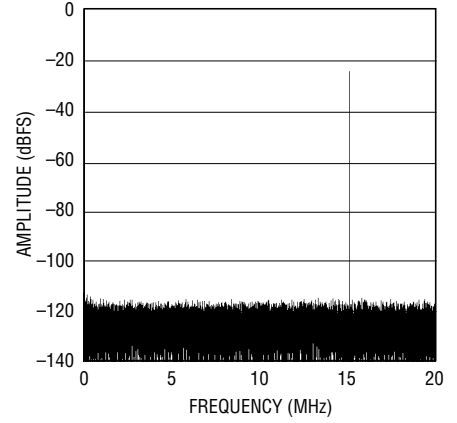

22054 G56

**LTC2204: 64K Point FFT,
40Msps, $f_{IN} = 15.1\text{MHz}$, -40dBFS ,
PGA = 0, DITH = 0**

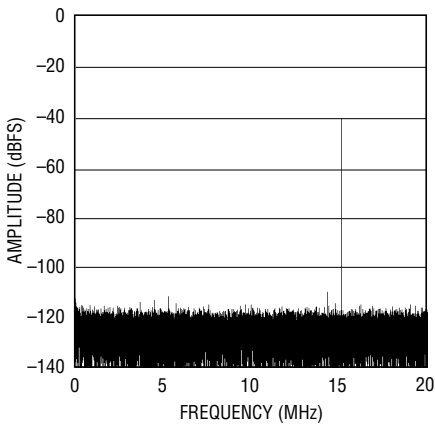

22054 G57

**LTC2204: 64K Point FFT,
40Msps, $f_{IN} = 15.1\text{MHz}$, -40dBFS ,
PGA = 0, DITH = 1**

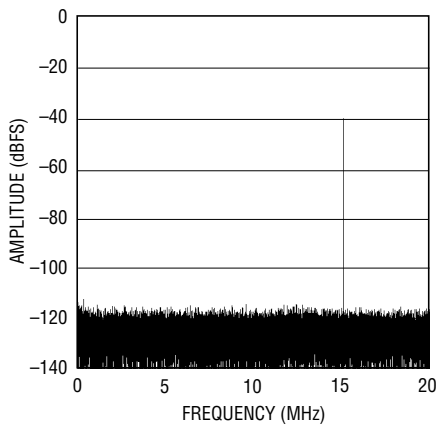

22054 G58

**LTC2204: 64K Point FFT,
40Msps, $f_{IN} = 70.1\text{MHz}$,
 -1dBFS , PGA = 0, DITH = 0**

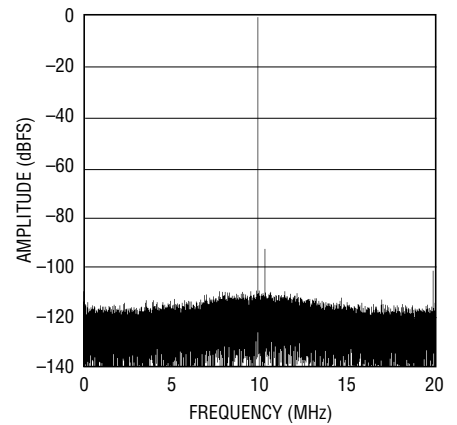

22054 G59

**LTC2204: 64K Point FFT,
40Msps, $f_{IN} = 70.1\text{MHz}$,
 -1dBFS , PGA = 1, DITH = 0**

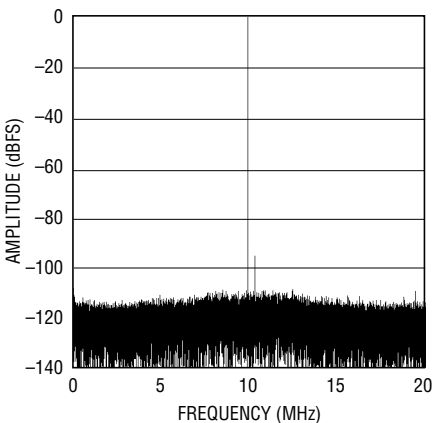

22054 G60

**LTC2204: 64K Point FFT,
40Msps, $f_{IN} = 70.1\text{MHz}$, -25dBFS ,
PGA = 0, DITH = 0**

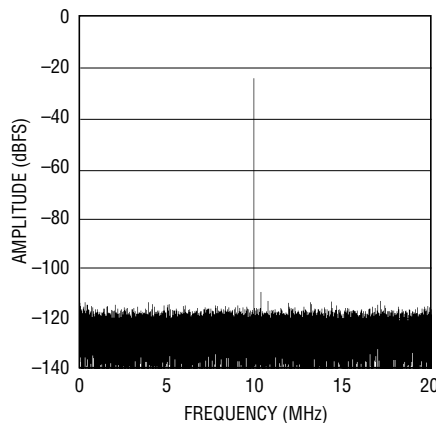

22054 G61

**LTC2204: 64K Point FFT,
40Msps, $f_{IN} = 70.1\text{MHz}$, -25dBFS ,
PGA = 0, DITH = 1**

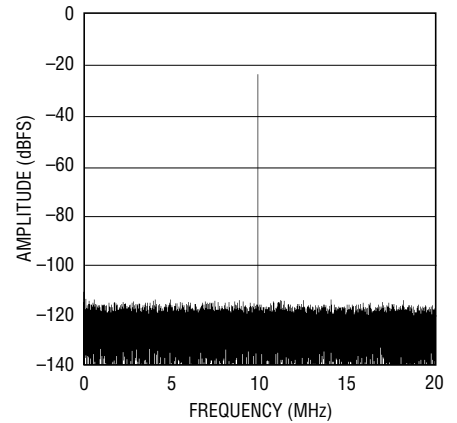

22054 G62

TYPICAL PERFORMANCE CHARACTERISTICS

**LTC2204: 64K Point FFT,
40Msps, $f_{IN} = 70.1\text{MHz}$, -40dBFS ,
PGA = 0, DITH = 0**

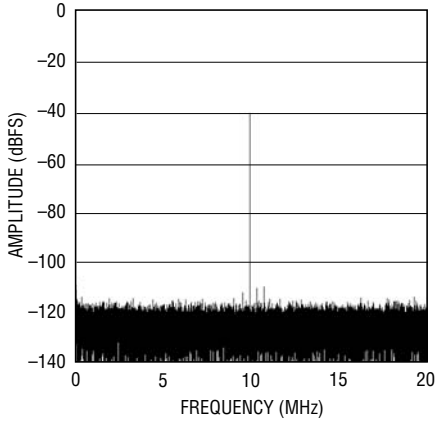

22054 G63

**LTC2204: 64K Point FFT,
40Msps, $f_{IN} = 70.1\text{MHz}$, -40dBFS ,
PGA = 0, DITH = 1**

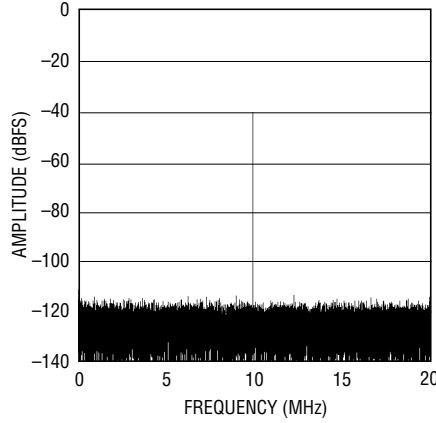

22054 G64

**LTC2204: 64K Point FFT,
40Msps, $f_{IN} = 140.1\text{MHz}$, -1dBFS ,
PGA = 0, DITH = 0**

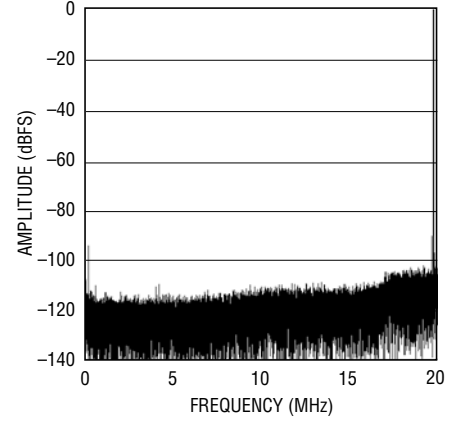

22054 G65

**LTC2204: 64K Point FFT,
40Msps, $f_{IN} = 140.1\text{MHz}$, -1dBFS ,
PGA = 1, DITH = 0**

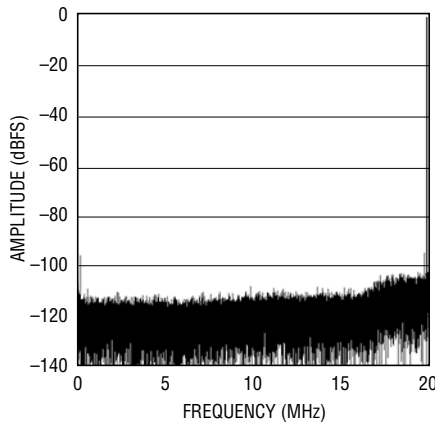

22054 G66

**LTC2204: 64K Point FFT,
40Msps, $f_{IN} = 140.1\text{MHz}$,
 -25dBFS , PGA = 0, DITH = 0**

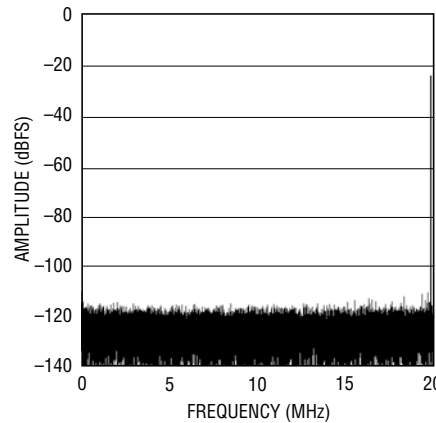

22054 G67

**LTC2204: 64K Point FFT,
40Msps, $f_{IN} = 140.1\text{MHz}$,
 -25dBFS , PGA = 0, DITH = 1**

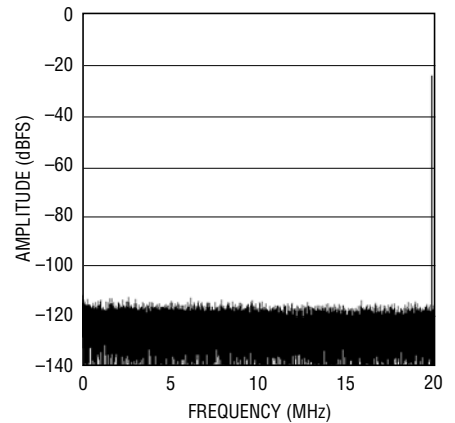

22054 G68

**LTC2204: 64K Point FFT,
40Msps, $f_{IN} = 140.1\text{MHz}$,
 -25dBFS , PGA = 0, DITH = 0**

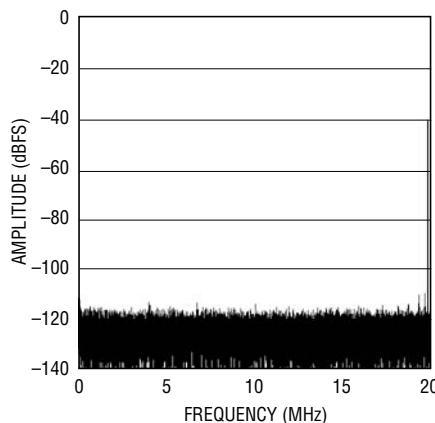

22054 G69

**LTC2204: 64K Point FFT,
40Msps, $f_{IN} = 140.1\text{MHz}$,
 -40dBFS , PGA = 0, DITH = 1**

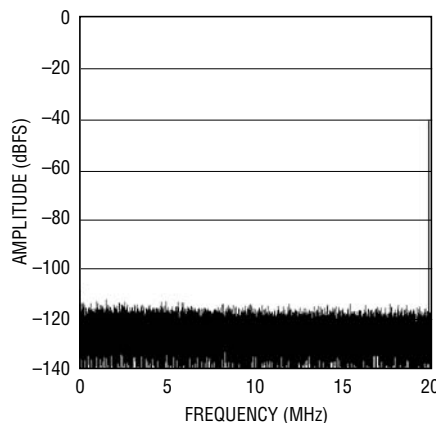

22054 G70

**LTC2204: 64K Point FFT, $f_{IN1} =$
 14.9MHz , -7dBFS , $f_{IN2} = 20.1\text{MHz}$,
 -7dBFS , PGA = 0, DITH = 0**

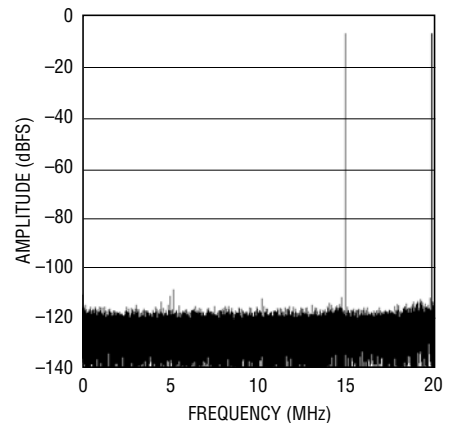

22054 G71

TYPICAL PERFORMANCE CHARACTERISTICS

LTC2204: 64K Point FFT, $f_{IN1} = 65.1\text{MHz}$, -7dBFS , $f_{IN2} = 70.1\text{MHz}$, -7dBFS , $\text{PGA} = 0$, $\text{DITH} = 0$

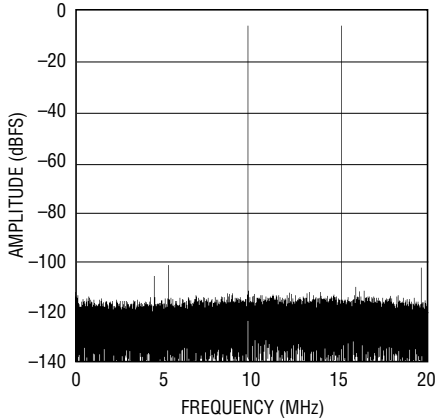

22054 G72

LTC2204: SFDR vs Input Level, $f_{IN} = 5.1\text{MHz}$, $\text{DITH} = 0$, $\text{RAND} = 1$

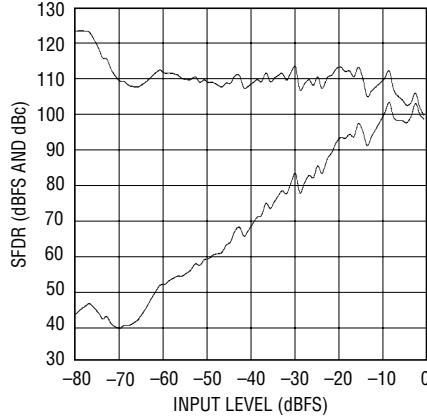

22054 G73

LTC2204: SFDR vs Input Level, $f_{IN} = 5.1\text{MHz}$, $\text{DITH} = 1$, $\text{RAND} = 1$

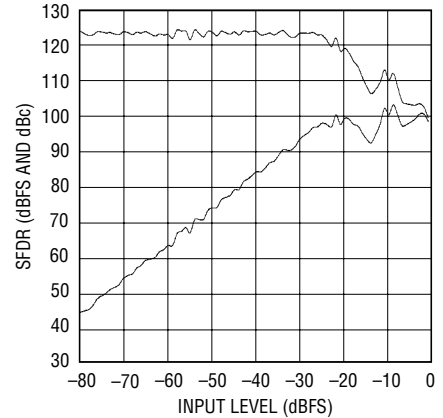

22054 G74

LTC2204: SFDR vs Input Level, $f_{IN} = 5.1\text{MHz}$, $\text{DITH} = 0$, $\text{RAND} = 1$

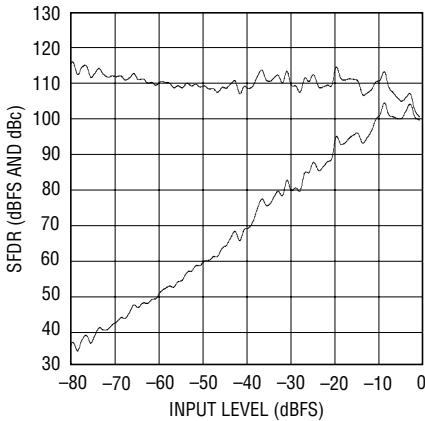

22054 G75

LTC2204: SFDR vs Input Level, $f_{IN} = 15.1\text{MHz}$, $\text{DITH} = 1$, $\text{RAND} = 1$

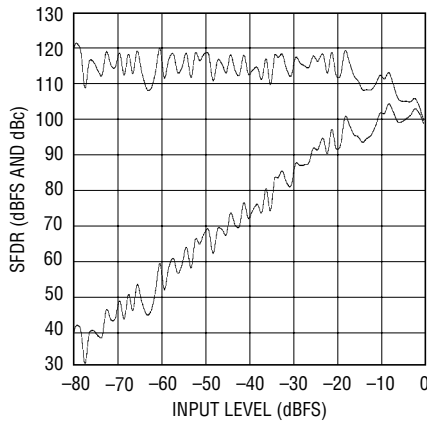

22054 G76

LTC2204: SFDR vs Input Level, $f_{IN} = 70.1\text{MHz}$, $\text{DITH} = 0$, $\text{RAND} = 1$

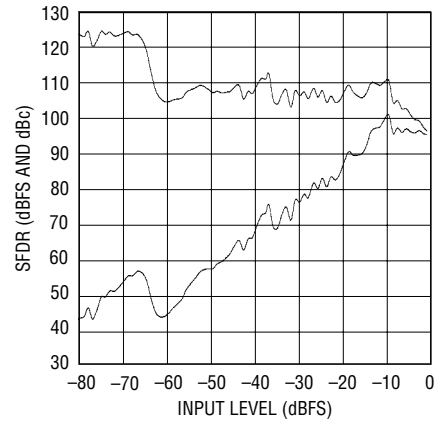

22054 G77

LTC2204: SFDR vs Input Level, $f_{IN} = 70.1\text{MHz}$, $\text{DITH} = 1$, $\text{RAND} = 1$

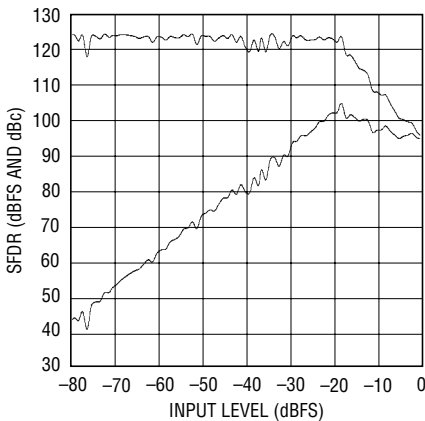

22054 G78

LTC2204: SFDR vs Input Level, $f_{IN} = 140.1\text{MHz}$, $\text{DITH} = 0$, $\text{RAND} = 1$

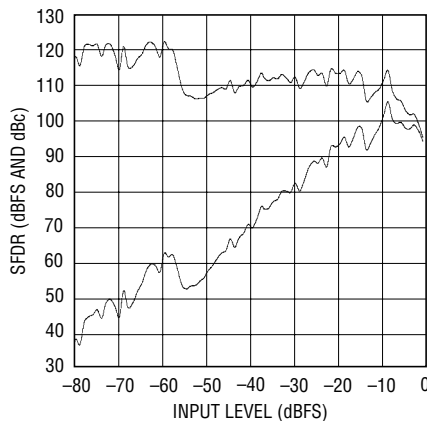

22054 G79

LTC2204: SFDR vs Input Level, $f_{IN} = 140.1\text{MHz}$, $\text{DITH} = 1$, $\text{RAND} = 1$

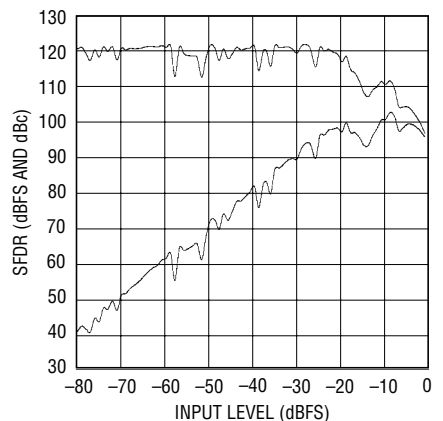

22054 G80

TYPICAL PERFORMANCE CHARACTERISTICS

LTC2204: SFDR vs Input Frequency, DITH = 0, RAND = 0

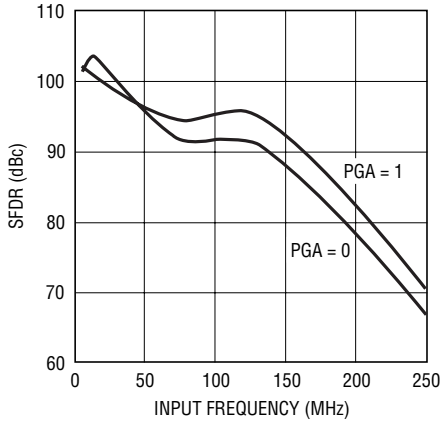

22054 G81

LTC2204: SNR vs Input Frequency, DITH = 0, RAND = 0

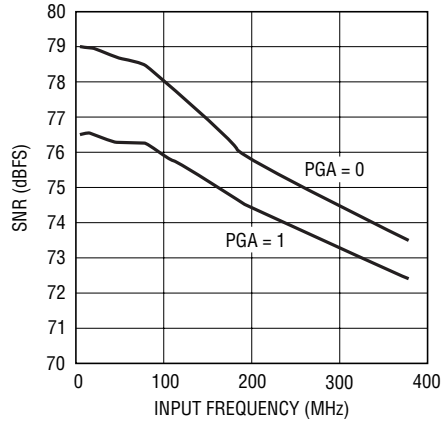

22054 G82

LTC2204: SFDR and SNR vs Sample Rate, $f_{IN} = 5.1\text{MHz}$, -1dBFS , PGA = 0, DITH = 0, RAND = 0

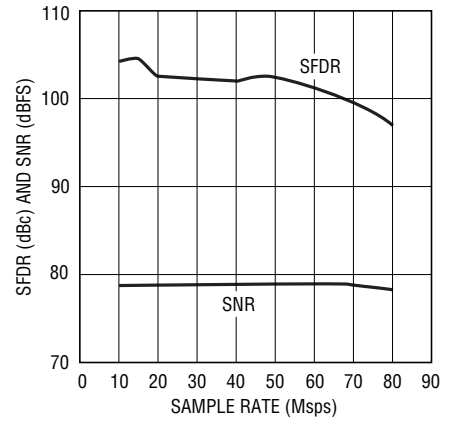

22054 G83

LTC2204: SFDR and SNR vs Supply Voltage, DITH = 0, RAND = 0

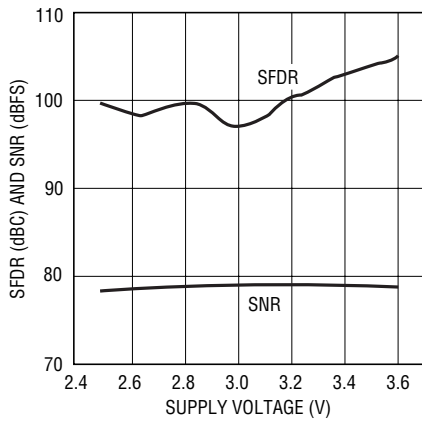

22054 G84

LTC2204: IVDD vs Sample Rate, $f_{IN} = 5.1\text{MHz}$, 1dBFS , DITH = 0, RAND = 0

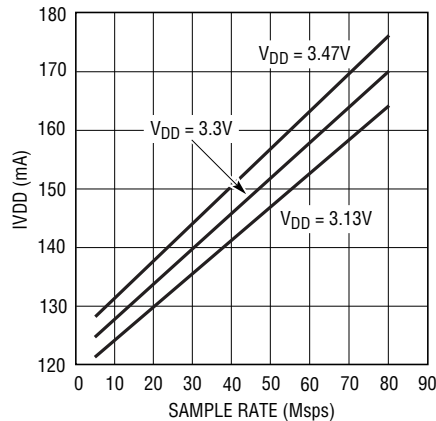

22054 G85

LTC2204: SNR and SFDR vs Input Common Mode Voltage, DITH = 0, RAND = 0

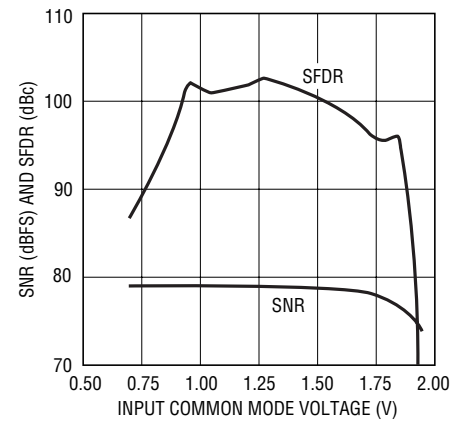

22054 G86

PIN FUNCTIONS

SENSE (Pin 1): Reference Mode Select and External Reference Input. Tie SENSE to V_{DD} to select the internal 2.5V bandgap reference. An external reference of 2.5V or 1.25V may be used; both reference values will set a full scale ADC range of 2.25V (PGA = 0).

V_{CM} (Pin 2): 1.25V Output. Optimum voltage for input common mode. Must be bypassed to ground with a minimum of 2.2 μ F. Ceramic chip capacitors are recommended.

V_{DD} (Pins 3, 4, 12, 13, 14): 3.3V Analog Supply Pin. Bypass to GND with 0.1 μ F ceramic chip capacitors.

GND (Pins 5, 8, 11, 15, 48, 49): ADC Power Ground.

A_{IN}^+ (Pin 6): Positive Differential Analog Input.

A_{IN}^- (Pin 7): Negative Differential Analog Input.

ENC⁺ (Pin 9): Positive Differential Encode Input. The sampled analog input is held on the rising edge of ENC⁺. Internally biased to 1.6V through a 6.2k Ω resistor. Output data can be latched on the rising edge of ENC⁺.

ENC⁻ (Pin 10): Negative Differential Encode Input. The sampled analog input is held on the falling edge of ENC⁻. Internally biased to 1.6V through a 6.2k Ω resistor. Bypass to ground with a 0.1 μ F capacitor for a single-ended Encode signal.

SHDN (Pin 16): Power Shutdown Pin. SHDN = low results in normal operation. SHDN = high results in powered down analog circuitry and the digital outputs placed in a high impedance state.

DITH (Pin 17): Internal Dither Enable Pin. DITH = low disables internal dither. DITH = high enables internal dither. Refer to Internal Dither section of this data sheet for details on dither operation.

D0-D15 (Pins 18-22, 26-28, 32-35 and 39-42): Digital Outputs. D15 is the MSB.

OGND (Pins 23, 31 and 38): Output Driver Ground.

OV_{DD} (Pins 24, 25, 36, 37): Positive Supply for the Output Drivers. Bypass to ground with 0.1 μ F ceramic chip capacitors.

CLKOUT⁻ (Pin 29): Data Valid Output. CLKOUT⁻ will toggle at the sample rate. Latch the data on the falling edge of CLKOUT⁻.

CLKOUT⁺ (Pin 30): Inverted Data Valid Output. CLKOUT⁺ will toggle at the sample rate. Latch the data on the rising edge of CLKOUT⁺.

OF (Pin 43): Over/Under Flow Digital Output. OF is high when an over or under flow has occurred.

\overline{OE} (Pin 44): Output Enable Pin. Low enables the digital output drivers. High puts digital outputs in Hi-Z state.

MODE (Pin 45): Output Format and Clock Duty Cycle Stabilizer Selection Pin. Connecting MODE to 0V selects offset binary output format and disables the clock duty cycle stabilizer. Connecting MODE to $1/3V_{DD}$ selects offset binary output format and enables the clock duty cycle stabilizer. Connecting MODE to $2/3V_{DD}$ selects 2's complement output format and enables the clock duty cycle stabilizer. Connecting MODE to V_{DD} selects 2's complement output format and disables the clock duty cycle stabilizer.

RAND (Pin 46): Digital Output Randomization Selection Pin. RAND low results in normal operation. RAND high selects D1-D15 to be EXCLUSIVE-ORed with D0 (the LSB). The output can be decoded by again applying an XOR operation between the LSB and all other bits. This mode of operation reduces the effects of digital output interference.

PGA (Pin 47): Programmable Gain Amplifier Control Pin. Low selects a front-end gain of 1, input range of 2.25V_{P-P}. High selects a front-end gain of 1.5, input range of 1.5V_{P-P}.

GND (Exposed Pad, Pin 49): ADC Power Ground. The exposed pad on the bottom of the package must be soldered to ground.

BLOCK DIAGRAM

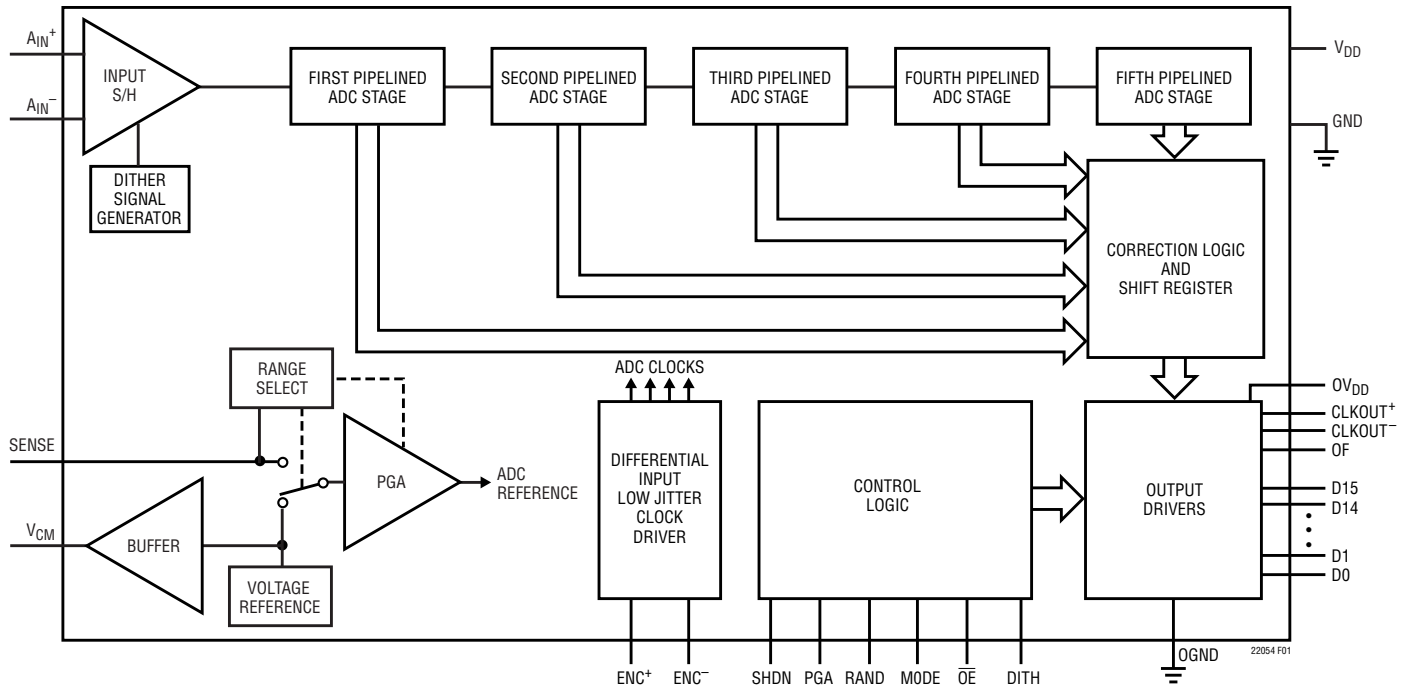

Figure 1. Functional Block Diagram

OPERATION

DYNAMIC PERFORMANCE

Signal-to-Noise Plus Distortion Ratio

The signal-to-noise plus distortion ratio [S/(N+D)] is the ratio between the RMS amplitude of the fundamental input frequency and the RMS amplitude of all other frequency components at the ADC output. The output is band limited to frequencies above DC to below half the sampling frequency.

Signal-to-Noise Ratio

The signal-to-noise (SNR) is the ratio between the RMS amplitude of the fundamental input frequency and the RMS amplitude of all other frequency components, except the first five harmonics.

Total Harmonic Distortion

Total harmonic distortion is the ratio of the RMS sum of all harmonics of the input signal to the fundamental itself. The out-of-band harmonics alias into the frequency band between DC and half the sampling frequency. THD is expressed as:

$$\text{THD} = -20\text{Log}\sqrt{(V_2^2 + V_3^2 + V_4^2 + \dots + V_N^2)/V_1^2}$$

where V_1 is the RMS amplitude of the fundamental frequency and V_2 through V_N are the amplitudes of the second through nth harmonics.

Intermodulation Distortion

If the ADC input signal consists of more than one spectral component, the ADC transfer function nonlinearity can produce intermodulation distortion (IMD) in addition to THD. IMD is the change in one sinusoidal input caused by the presence of another sinusoidal input at a different frequency.

If two pure sine waves of frequencies f_a and f_b are applied to the ADC input, nonlinearities in the ADC transfer function can create distortion products at the sum and difference frequencies of $m f_a \pm n f_b$, where m and $n = 0, 1, 2, 3$, etc. For example, the 3rd order IMD terms include $(2f_a + f_b)$, $(f_a + 2f_b)$, $(2f_a - f_b)$ and $(f_a - 2f_b)$. The 3rd order IMD is defined as the ratio of the RMS value of either input tone to the RMS value of the largest 3rd order IMD product.

Spurious Free Dynamic Range (SFDR)

The ratio of the RMS input signal amplitude to the RMS value of the peak spurious spectral component expressed in dBc. SFDR may also be calculated relative to full scale and expressed in dBFS.

Full Power Bandwidth

The Full Power bandwidth is that input frequency at which the amplitude of the reconstructed fundamental is reduced by 3dB for a full scale input signal.

Aperture Delay Time

The time from when a rising ENC^+ equals the ENC^- voltage to the instant that the input signal is held by the sample-and-hold circuit.

Aperture Delay Jitter

The variation in the aperture delay time from conversion to conversion. This random variation will result in noise when sampling an AC input. The signal to noise ratio due to the jitter alone will be:

$$\text{SNR}_{\text{JITTER}} = -20\text{log}(2\pi \cdot f_{\text{IN}} \cdot t_{\text{JITTER}})$$

APPLICATIONS INFORMATION

CONVERTER OPERATION

The LTC2205/LTC2204 are CMOS pipelined multistep converters with a front-end PGA. As shown in Figure 1, the converter has five pipelined ADC stages; a sampled analog input will result in a digitized value seven cycles later (see the Timing Diagram section). The analog input is differential for improved common mode noise immunity and to maximize the input range. Additionally, the differential input drive will reduce even order harmonics of the sample and hold circuit. The encode input is also differential for improved common mode noise immunity.

The LTC2205/LTC2204 have two phases of operation, determined by the state of the differential ENC^+/ENC^- input pins. For brevity, the text will refer to ENC^+ greater than ENC^- as ENC high and ENC^+ less than ENC^- as ENC low.

Each pipelined stage shown in Figure 1 contains an ADC, a reconstruction DAC and a residue amplifier. In operation, the ADC quantizes the input to the stage, and the quantized value is subtracted from the input by the DAC to produce a residue. The residue is amplified and output by the residue amplifier. Successive stages operate out of phase so that when odd stages are outputting

their residue, the even stages are acquiring that residue and vice versa.

When ENC is low, the analog input is sampled differentially directly onto the input sample-and-hold capacitors, inside the “input S/H” shown in the block diagram. At the instant that ENC transitions from low to high, the voltage on the sample capacitors is held. While ENC is high, the held input voltage is buffered by the S/H amplifier which drives the first pipelined ADC stage. The first stage acquires the output of the S/H amplifier during the high phase of ENC. When ENC goes back low, the first stage produces its residue which is acquired by the second stage. At the same time, the input S/H goes back to acquiring the analog input. When ENC goes high, the second stage produces its residue which is acquired by the third stage. An identical process is repeated for the third and fourth stages, resulting in a fourth stage residue that is sent to the fifth stage for final evaluation.

Each ADC stage following the first has additional range to accommodate flash and amplifier offset errors. Results from all of the ADC stages are digitally delayed such that the results can be properly combined in the correction logic before being sent to the output buffer.

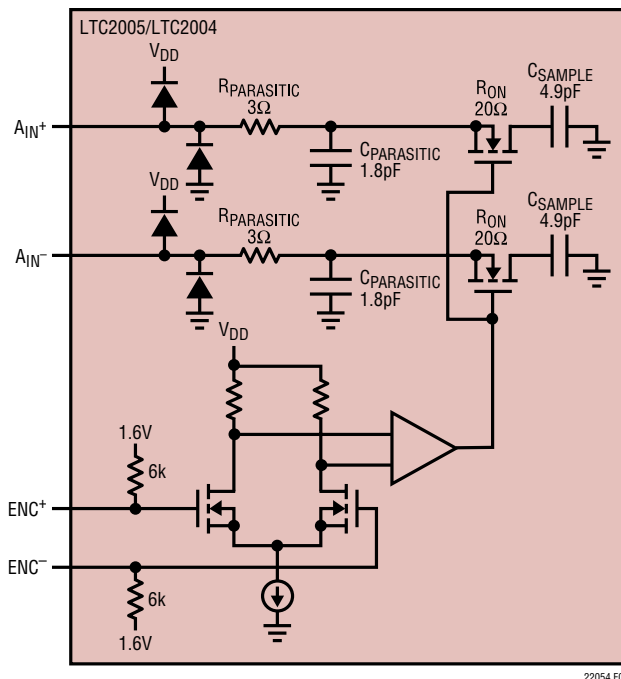

Figure 2. Equivalent Input Circuit

APPLICATIONS INFORMATION

SAMPLE/HOLD OPERATION AND INPUT DRIVE

Sample/Hold Operation

Figure 2 shows an equivalent circuit for the LTC2205/LTC2204 CMOS differential sample and hold. The differential analog inputs are sampled directly onto sampling capacitors (C_{SAMPLE}) through NMOS transistors. The capacitors shown attached to each input ($C_{\text{PARASITIC}}$) are the summation of all other capacitance associated with each input.

During the sample phase when ENC is low, the NMOS transistors connect the analog inputs to the sampling capacitors which charge to, and track the differential input voltage. When ENC transitions from low to high, the sampled input voltage is held on the sampling capacitors. During the hold phase when ENC is high, the sampling capacitors are disconnected from the input and the held voltage is passed to the ADC core for processing. As ENC transitions for high to low, the inputs are reconnected to the sampling capacitors to acquire a new sample. Since the sampling capacitors still hold the previous sample, a charging glitch proportional to the change in voltage between samples will be seen at this time. If the change between the last sample and the new sample is small, the charging glitch seen at the input will be small. If the input change is large, such as the change seen with input frequencies near Nyquist, then a larger charging glitch will be seen.

Common Mode Bias

The ADC sample-and-hold circuit requires differential drive to achieve specified performance. Each input should swing $\pm 0.5625\text{V}$ for the 2.25V range ($\text{PGA} = 0$) or $\pm 0.375\text{V}$ for the 1.5V range ($\text{PGA} = 1$), around a common mode voltage of 1.25V. The V_{CM} output pin (Pin 2) is designed to provide the common mode bias level. V_{CM} can be tied directly to the center tap of a transformer to set the DC input level or as a reference level to an op amp differential driver circuit. The V_{CM} pin must be bypassed to ground close to the ADC with 2.2 μF or greater.

Input Drive Impedance

As with all high performance, high speed ADCs the dynamic performance of the LTC2205/LTC2204 can be influenced by the input drive circuitry, particularly the second and third harmonics. Source impedance and input reactance can influence SFDR. At the falling edge of ENC the sample-and-hold circuit will connect the 4.9pF sampling capacitor to the input pin and start the sampling period. The sampling period ends when ENC rises, holding the sampled input on the sampling capacitor. Ideally, the input circuitry should be fast enough to fully charge the sampling capacitor during the sampling period $1/(2F_{\text{ENCODE}})$; however, this is not always possible and the incomplete settling may degrade the SFDR. The sampling glitch has been designed to be as linear as possible to minimize the effects of incomplete settling.

For the best performance it is recommended to have a source impedance of 100 Ω or less for each input. The source impedance should be matched for the differential inputs. Poor matching will result in higher even order harmonics, especially the second.

INPUT DRIVE CIRCUITS

Input Filtering

A first order RC lowpass filter at the input of the ADC can serve two functions: limit the noise from input circuitry and provide isolation from ADC S/H switching. The LTC2205/LTC2204 have a very broadband S/H circuit, DC to 700MHz; it can be used in a wide range of applications; therefore, it is not possible to provide a single recommended RC filter.

Figures 3, 4a and 4b show three examples of input RC filtering at three ranges of input frequencies. In general it is desirable to make the capacitors as large as can be tolerated—this will help suppress random noise as well as noise coupled from the digital circuitry. The LTC2205/LTC2204 do not require any input filter to achieve data sheet specifications; however, no filtering will put more stringent noise requirements on the input drive circuitry.

APPLICATIONS INFORMATION

Transformer Coupled Circuits

Figure 3 shows the LTC2205/LTC2204 being driven by an RF transformer with a center-tapped secondary. The secondary center tap is DC biased with V_{CM} , setting the ADC input signal at its optimum DC level. Figure 3 shows a 1:1 turns ratio transformer. Other turns ratios can be used; however, as the turns ratio increases so does the impedance seen by the ADC. Source impedance greater than 50Ω can reduce the input bandwidth and increase high frequency distortion. A disadvantage of using a transformer is the loss of low frequency response. Most small RF transformers have poor performance at frequencies below 1MHz.

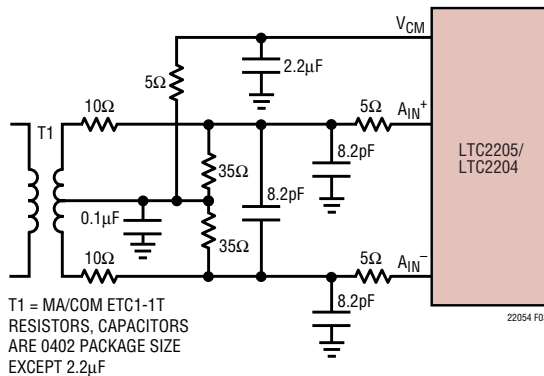

Figure 3. Single-Ended to Differential Conversion Using a Transformer.
Recommended for Input Frequencies from 5MHz to 150MHz

Center-tapped transformers provide a convenient means of DC biasing the secondary; however, they often show poor balance at high input frequencies, resulting in large 2nd order harmonics.

Figure 4a shows transformer coupling using a transmission line balun transformer. This type of transformer has much better high frequency response and balance than flux coupled center tap transformers. Coupling capacitors are added at the ground and input primary terminals to allow the secondary terminals to be biased at 1.25V. Figure 4b shows the same circuit with components suitable for higher input frequencies.

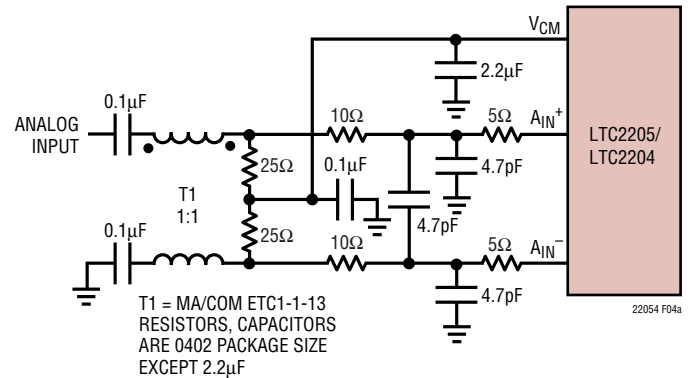

Figure 4a. Using a Transmission Line Balun Transformer.
Recommended for Input Frequencies from 70MHz to 250MHz

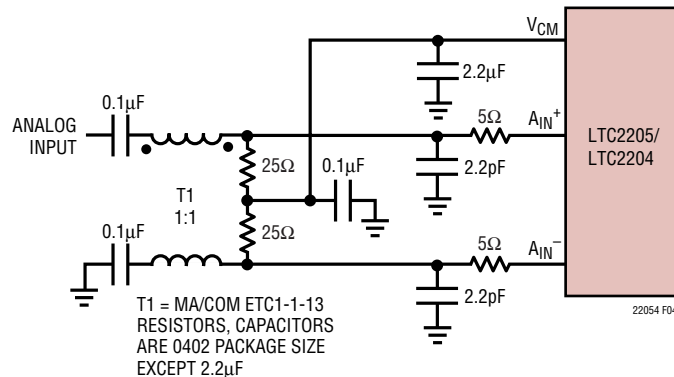

Figure 4b. Using a Transmission Line Balun Transformer.
Recommended for Input Frequencies from 250MHz to 500MHz

APPLICATIONS INFORMATION

Direct Coupled Circuits

Figure 5 demonstrates the use of a differential amplifier to convert a single ended input signal into a differential input signal. The advantage of this method is that it provides low frequency input response; however, the limited gain bandwidth of any op amp or closed-loop amplifier will degrade the ADC SFDR at high input frequencies. Additionally, wideband op amps or differential amplifiers tend to have high noise. As a result, the SNR will be degraded unless the noise bandwidth is limited prior to the ADC input.

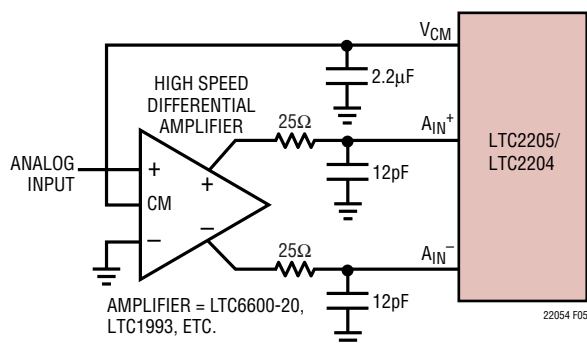

Figure 5. DC Coupled Input with Differential Amplifier

Reference Operation

Figure 6 shows the LTC2205/LTC2204 reference circuitry consisting of a 2.5V bandgap reference, a programmable gain amplifier and control circuit. The LTC2205/LTC2204 have three modes of reference operation: Internal Reference, 1.25V external reference or 2.5V external reference. To use the internal reference, tie the SENSE pin to V_{DD} . To use an external reference, simply apply either a 1.25V or 2.5V reference voltage to the SENSE input pin. Both 1.25V and 2.5V applied to SENSE will result in a full scale range of 2.25V_{P-P} (PGA = 0). A 1.25V output, V_{CM} is provided for a common mode bias for input drive circuitry. An external bypass capacitor is required for the V_{CM} output. This provides a high frequency low impedance path to ground for internal and external circuitry. This is also the compensation capacitor for the reference; it will not be stable without this capacitor. The minimum value required for stability is 2.2μF.

The internal programmable gain amplifier provides the internal reference voltage for the ADC. This amplifier has

very stringent settling requirements and is not accessible for external use.

The SENSE pin can be driven $\pm 5\%$ around the nominal 2.5V or 1.25V external reference inputs. This adjustment range can be used to trim the ADC gain error or other system gain errors. When selecting the internal reference, the SENSE pin should be tied to V_{DD} as close to the converter as possible. If the sense pin is driven externally it should be bypassed to ground as close to the device as possible with 1μF (or larger) ceramic capacitor.

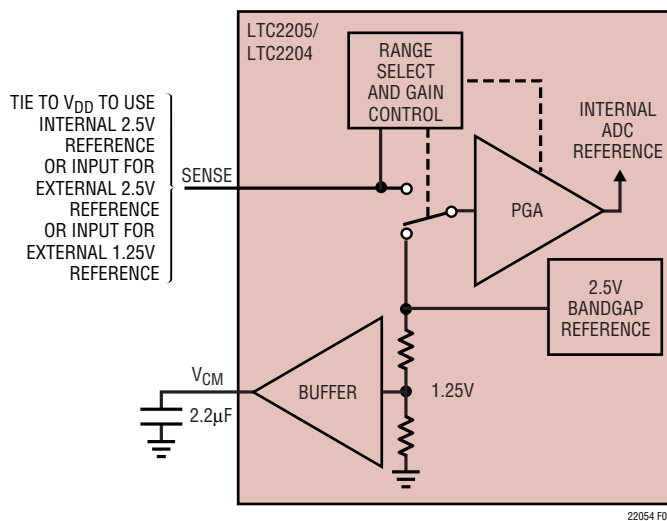

Figure 6. Reference Circuit

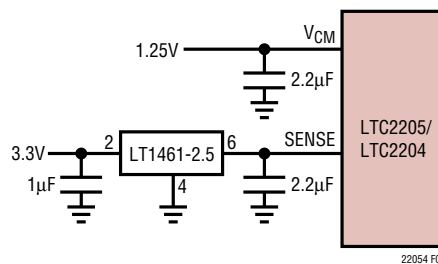

Figure 7. A 2.5V Range ADC with an External 2.5V Reference

APPLICATIONS INFORMATION

PGA Pin

The PGA pin selects between two gain settings for the ADC front-end. $PGA = 0$ selects an input range of $2.25V_{P-P}$; $PGA = 1$ selects an input range of $1.5V_{P-P}$. The $2.25V$ input range has the best SNR; however, the distortion will be higher for input frequencies above $100MHz$. For applications with high input frequencies, the low input range will have improved distortion; however, the SNR will be worse by up to approximately $2dB$ to $6dB$. See the typical performance curves section.

Driving the Encode Inputs

The noise performance of the LTC2205/LTC2204 can depend on the encode signal quality as much as on the analog input. The encode inputs are intended to be driven differentially, primarily for noise immunity from common mode noise sources. Each input is biased through a $6k$ resistor to a $1.6V$ bias. The bias resistors set the DC operating point for transformer coupled drive circuits and can set the logic threshold for single-ended drive circuits.

Any noise present on the encode signal will result in additional aperture jitter that will be RMS summed with the inherent ADC aperture jitter.

In applications where jitter is critical (high input frequencies), take the following into consideration:

1. Differential drive should be used.
2. Use as large an amplitude possible. If using transformer coupling, use a higher turns ratio to increase the amplitude.
3. If the ADC is clocked with a fixed frequency sinusoidal signal, filter the encode signal to reduce wideband noise.
4. Balance the capacitance and series resistance at both encode inputs such that any coupled noise will appear at both inputs as common mode noise.

The encode inputs have a common mode range of $1.2V$ to $3V$. Each input may be driven from ground to V_{DD} for single-ended drive.

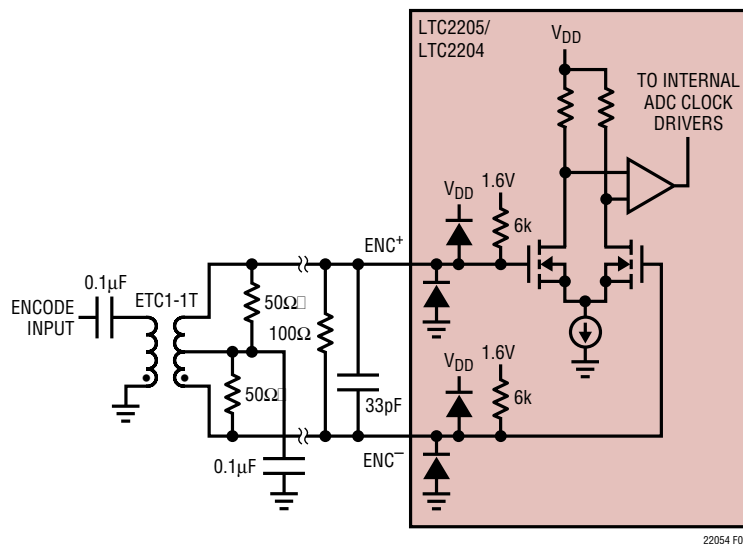

Figure 8. Transformer Driven Encode

APPLICATIONS INFORMATION

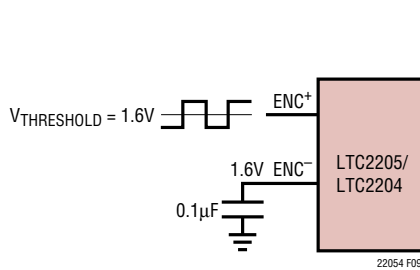

Figure 9. Single-Ended ENC Drive, Not Recommended for Low Jitter

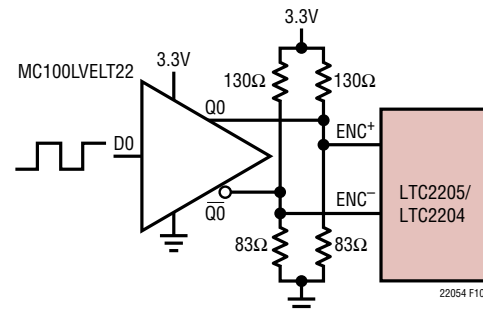

Figure 10. ENC Drive Using a CMOS to PECL Translator

Maximum and Minimum Encode Rates

The maximum encode rate for the LTC2205 is 65MSPS. The maximum encode rate for the LTC2204 is 40MSPS. For the ADC to operate properly the encode signal should have a 50% ($\pm 2.5\%$) duty cycle. Achieving a precise 50% duty cycle is easy with differential sinusoidal drive using a transformer or using symmetric differential logic such as PECL or LVDS. When using a single-ended ENCODE signal asymmetric rise and fall times can result in duty cycles that are far from 50%.

An optional clock duty cycle stabilizer can be used if the input clock does not have a 50% duty cycle. This circuit uses the rising edge of ENC pin to sample the analog input. The falling edge of ENC is ignored and an internal falling

edge is generated by a phase-locked loop. The input clock duty cycle can vary from 30% to 70% and the clock duty cycle stabilizer will maintain a constant 50% internal duty cycle. If the clock is turned off for a long period of time, the duty cycle stabilizer circuit will require one hundred clock cycles for the PLL to lock onto the input clock. To use the clock duty cycle stabilizer, the MODE pin must be connected to $1/3V_{DD}$ or $2/3V_{DD}$ using external resistors.

The lower limit of the LTC2205/LTC2204 sample rate is determined by droop of the sample and hold circuits. The pipelined architecture of this ADC relies on storing analog signals on small valued capacitors. Junction leakage will discharge the capacitors. The specified minimum operating frequency for the LTC2205/LTC2204 is 1MSPS.

APPLICATIONS INFORMATION

DIGITAL OUTPUTS

Digital Output Buffers

Figure 11 shows an equivalent circuit for a single output buffer. Each buffer is powered by OV_{DD} and $OGND$, isolated from the ADC power and ground. The additional N-channel transistor in the output driver allows operation down to low voltages. The internal resistor in series with the output eliminates the need for external damping resistors.

As with all high speed/high resolution converters, the digital output loading can affect the performance. The digital outputs of the LTC2205/LTC2204 should drive a minimum capacitive load to avoid possible interaction between the digital outputs and sensitive input circuitry. The output should be buffered with a device such as a ALVCH16373 CMOS latch. For full speed operation the capacitive load should be kept under 10pF. A resistor in series with the output may be used but is not required since the ADC has a series resistor of 33Ω on chip.

Lower OV_{DD} voltages will also help reduce interference from the digital outputs.

Data Format

The LTC2205/LTC2204 parallel digital output can be selected for offset binary or 2's complement format. The format is selected with the MODE pin. This pin has a four level logic input, centered at 0, $1/3V_{DD}$, $2/3V_{DD}$ and V_{DD} . An external resistor divider can be user to set the $1/3V_{DD}$ and $2/3V_{DD}$ logic levels. Table 1 shows the logic states for the MODE pin.

Table 1. MODE Pin Function

MODE	Output Format	Clock Duty Cycle Stabilizer
0(GND)	Offset Binary	Off
$1/3V_{DD}$	Offset Binary	On
$2/3V_{DD}$	2's Complement	On
V_{DD}	2's Complement	Off

Overflow Bit

An overflow output bit (OF) indicates when the converter is over-ranged or under-ranged. A logic high on the OF pin indicates an overflow or underflow.

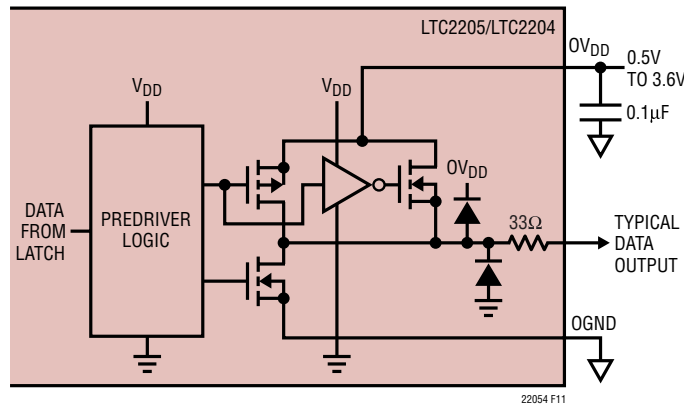

Figure 11. Equivalent Circuit for a Digital Output Buffer

APPLICATIONS INFORMATION

Output Clock

The ADC has a delayed version of the encode input available as a digital output. Both a noninverted version, CLKOUT⁺ and an inverted version CLKOUT⁻ are provided. The CLKOUT⁺/CLKOUT⁻ can be used to synchronize the converter data to the digital system. This is necessary when using a sinusoidal encode. Data can be latched on the rising edge of CLKOUT⁺ or the falling edge of CLKOUT⁻. CLKOUT⁺ falls and CLKOUT⁻ rises as the data outputs are updated.

Digital Output Randomizer

Interference from the ADC digital outputs is sometimes unavoidable. Interference from the digital outputs may be

from capacitive or inductive coupling or coupling through the ground plane. Even a tiny coupling factor can result in discernible unwanted tones in the ADC output spectrum. By randomizing the digital output before it is transmitted off chip, these unwanted tones can be randomized, trading a slight increase in the noise floor for a large reduction in unwanted tone amplitude.

The digital output is “Randomized” by applying an exclusive-OR logic operation between the LSB and all other data output bits. To decode, the reverse operation is applied; that is, an exclusive-OR operation is applied between the LSB, OF and CLKOUT output are not affected. The output Randomizer function is active when the RAND pin is high.

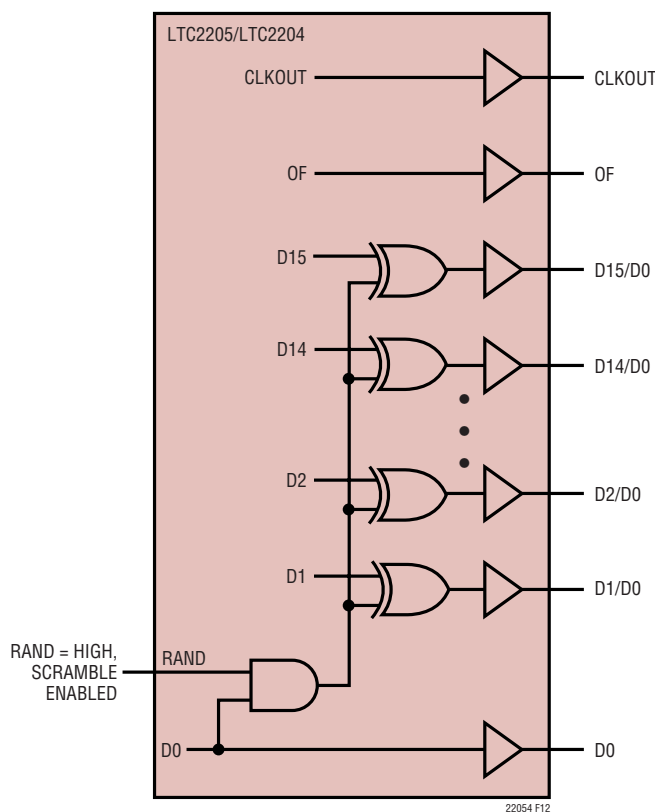

Figure 12. Functional Equivalent of Digital Output Randomizer

APPLICATIONS INFORMATION

Output Driver Power

Separate output power and ground pins allow the output drivers to be isolated from the analog circuitry. The power supply for the digital output buffers, OV_{DD} , should be tied to the same power supply as for the logic being driven. OV_{DD} can be powered with any logic voltage up to the V_{DD} of the ADC. $OGND$ can be powered with any voltage from ground up to 1V and must be less than OV_{DD} . The logic outputs will swing between $OGND$ and OV_{DD} .

Internal Dither

The LTC2205/LTC2204 are 16-bit ADCs with very linear transfer functions; however, at low input levels even slight imperfections in the transfer function will result in unwanted tones. Small errors in the transfer function are

usually a result of ADC element mismatches. An optional internal dither mode can be enabled to randomize the input location on the ADC transfer curve, resulting in improved SFDR for low signal levels.

As shown in Figure 14, the output of the sample-and-hold amplifier is summed with the output of a dither DAC. The dither DAC is driven by a long sequence pseudo-random number generator; the random number fed to the dither DAC is also subtracted from the ADC result. If the dither DAC is precisely calibrated to the ADC, very little of the dither signal will be seen at the output. The dither signal that does leak through will appear as white noise. The dither DAC is calibrated to result in less than 0.5dB elevation in the noise floor of the ADC, as compared to the noise floor with dither off.

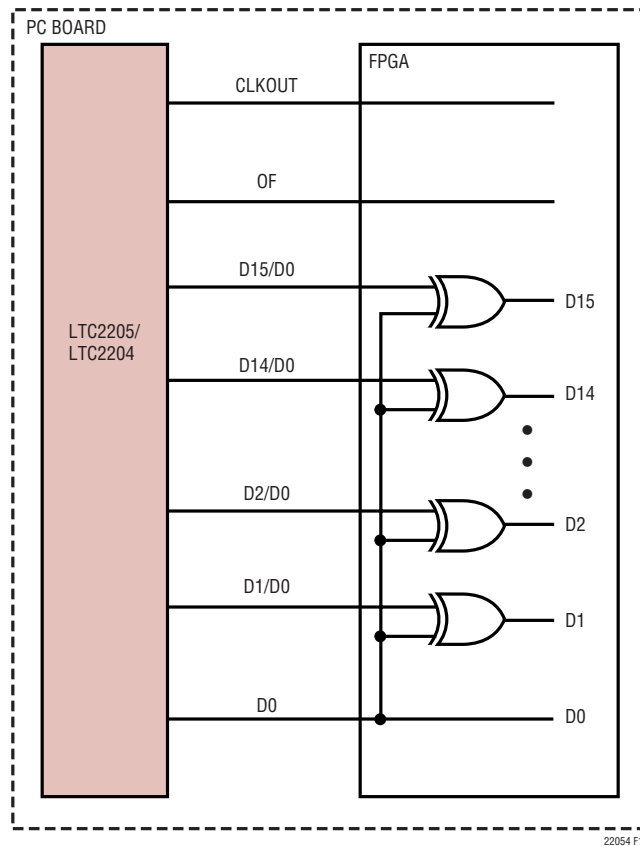

Figure 13. Descrambling a Scrambled Digital Output

APPLICATIONS INFORMATION

Grounding and Bypassing

The LTC2205/LTC2204 require a printed circuit board with a clean unbroken ground plane; a multilayer board with an internal ground plane is recommended. The pinout of the LTC2205/LTC2204 has been optimized for a flowthrough layout so that the interaction between inputs and digital outputs is minimized. Layout for the printed circuit board should ensure that digital and analog signal lines are separated as much as possible. In particular, care should be taken not to run any digital track alongside an analog signal track or underneath the ADC.

High quality ceramic bypass capacitors should be used at the V_{DD} , V_{CM} , and OV_{DD} pins. Bypass capacitors must be located as close to the pins as possible. The traces connecting the pins and bypass capacitors must be kept short and should be made as wide as possible.

The LTC2205/LTC2204 differential inputs should run parallel and close to each other. The input traces should be as short as possible to minimize capacitance and to minimize noise pickup.

Heat Transfer

Most of the heat generated by the LTC2205/LTC2204 is transferred from the die through the bottom-side exposed pad. For good electrical and thermal performance, the exposed pad must be soldered to a large grounded pad on the PC board. It is critical that the exposed pad and all ground pins are connected to a ground plane of sufficient area with as many vias as possible.

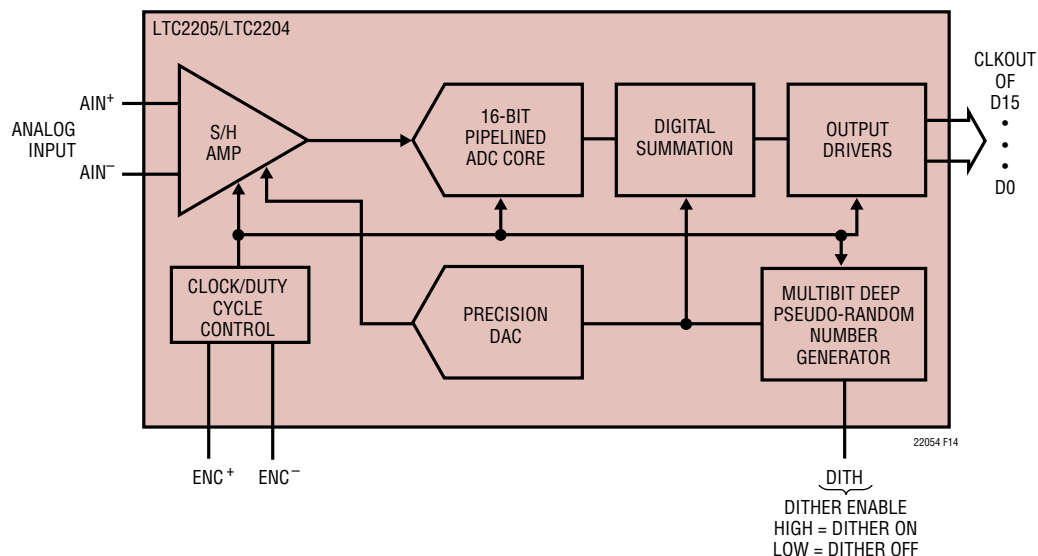
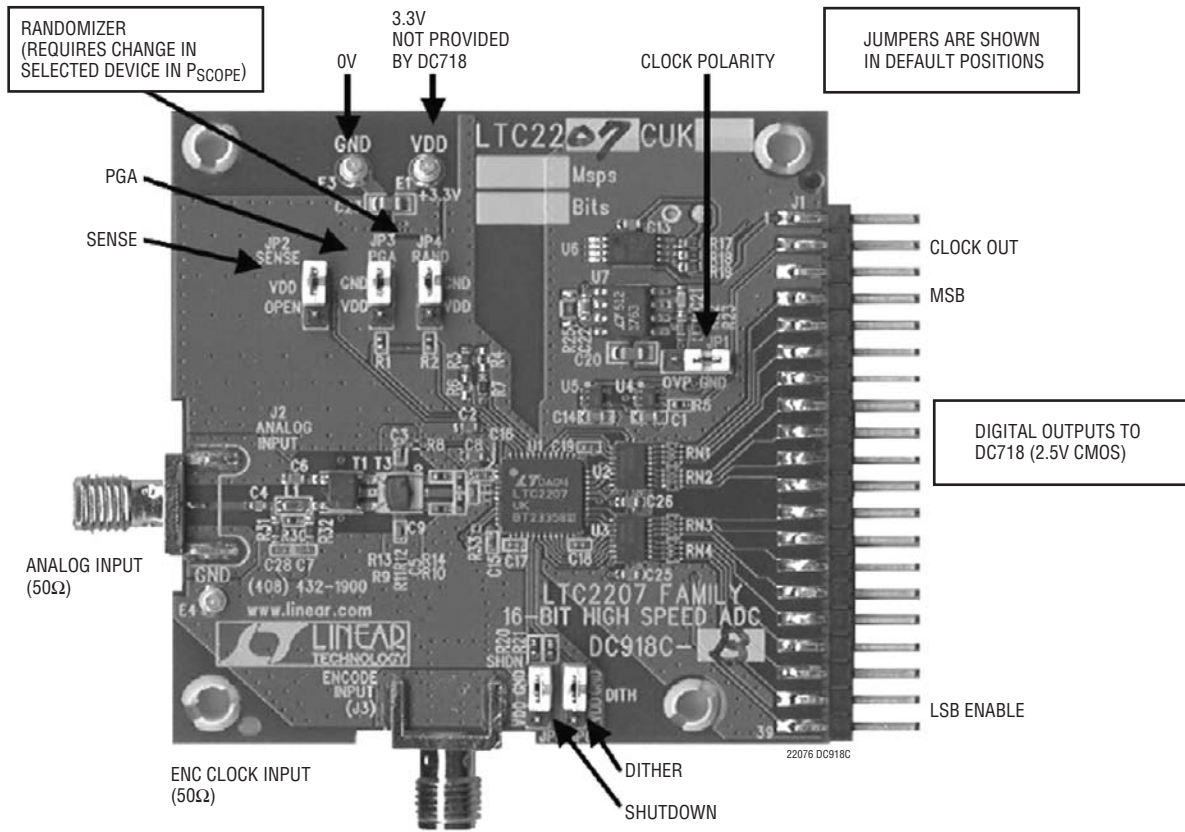

Figure 14. Functional Equivalent Block Diagram of Internal Dither Circuit

APPLICATIONS INFORMATION



Ordering Guide:

DEMO BOARD NUMBER	PART NUMBER	RESOLUTION	SPEED	INPUT FREQUENCY	USB I/F BOARD
DC918C-A	LTC2207CUK	16-Bit	105Msps	1MHz to 70MHz	DC718
DC918C-B	LTC2207CUK	16-Bit	105Msps	70MHz to 140MHz	DC718
DC918C-C	LTC2206CUK	16-Bit	80Msps	1MHz to 70MHz	DC718
DC918C-D	LTC2206CUK	16-Bit	80Msps	70MHz to 140MHz	DC718
DC918C-E	LTC2205CUK	16-Bit	65Msps	1MHz to 70MHz	DC718
DC918C-F	LTC2205CUK	16-Bit	65Msps	70MHz to 140MHz	DC718
DC918C-G	LTC2204CUK	16-Bit	40Msps	1MHz to 70MHz	DC718
DC918C-H	LTC2207CUK-14	14-Bit	105Msps	1MHz to 70MHz	DC718
DC918C-I	LTC2207CUK-14	14-Bit	105Msps	70MHz to 140MHz	DC718
DC918C-J	LTC2206CUK-14	14-Bit	80Msps	1MHz to 70MHz	DC718
DC918C-K	LTC2206CUK-14	14-Bit	80Msps	70MHz to 140MHz	DC718
DC918C-L	LTC2205CUK-14	14-Bit	65Msps	1MHz to 70MHz	DC718

See Web site for ordering details or contact local sales.

APPLICATIONS INFORMATION

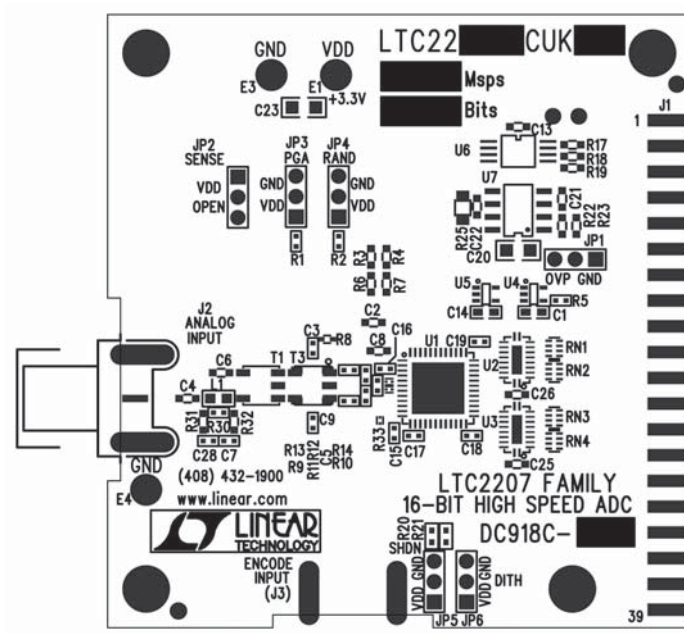

Silkscreen Top

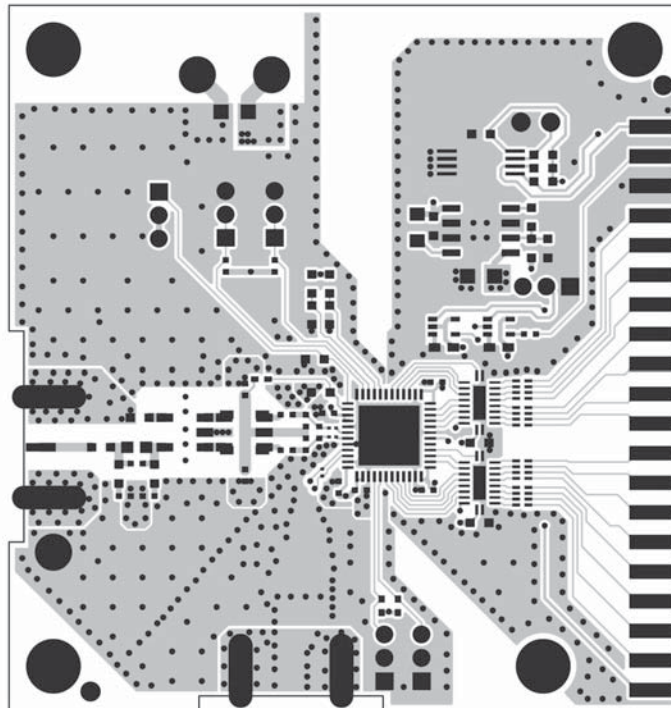

Top Side

APPLICATIONS INFORMATION



Inner Layer 2



Inner Layer 3



Inner Layer 4



Inner Layer 5

APPLICATIONS INFORMATION



Bottom Side

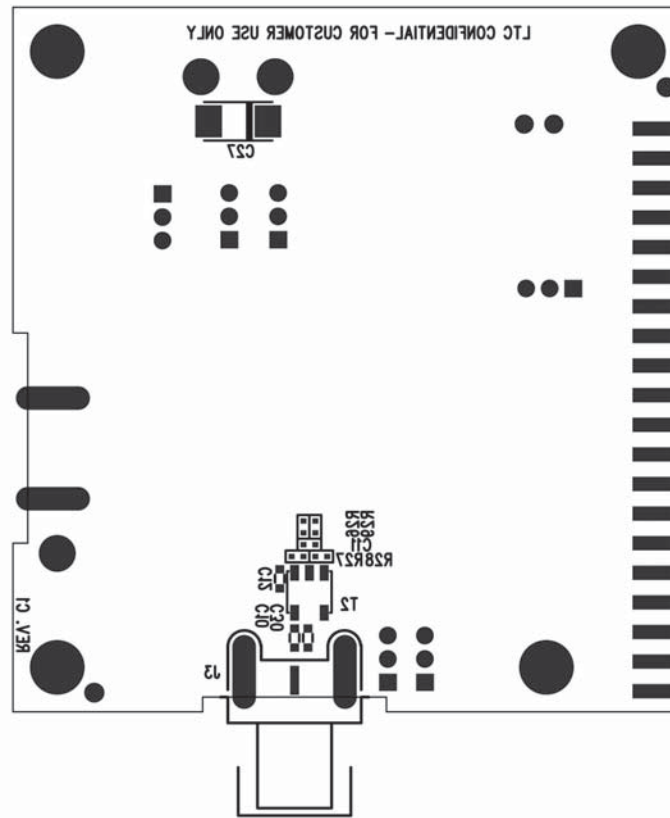

Silkscreen Bottom

APPLICATIONS INFORMATION

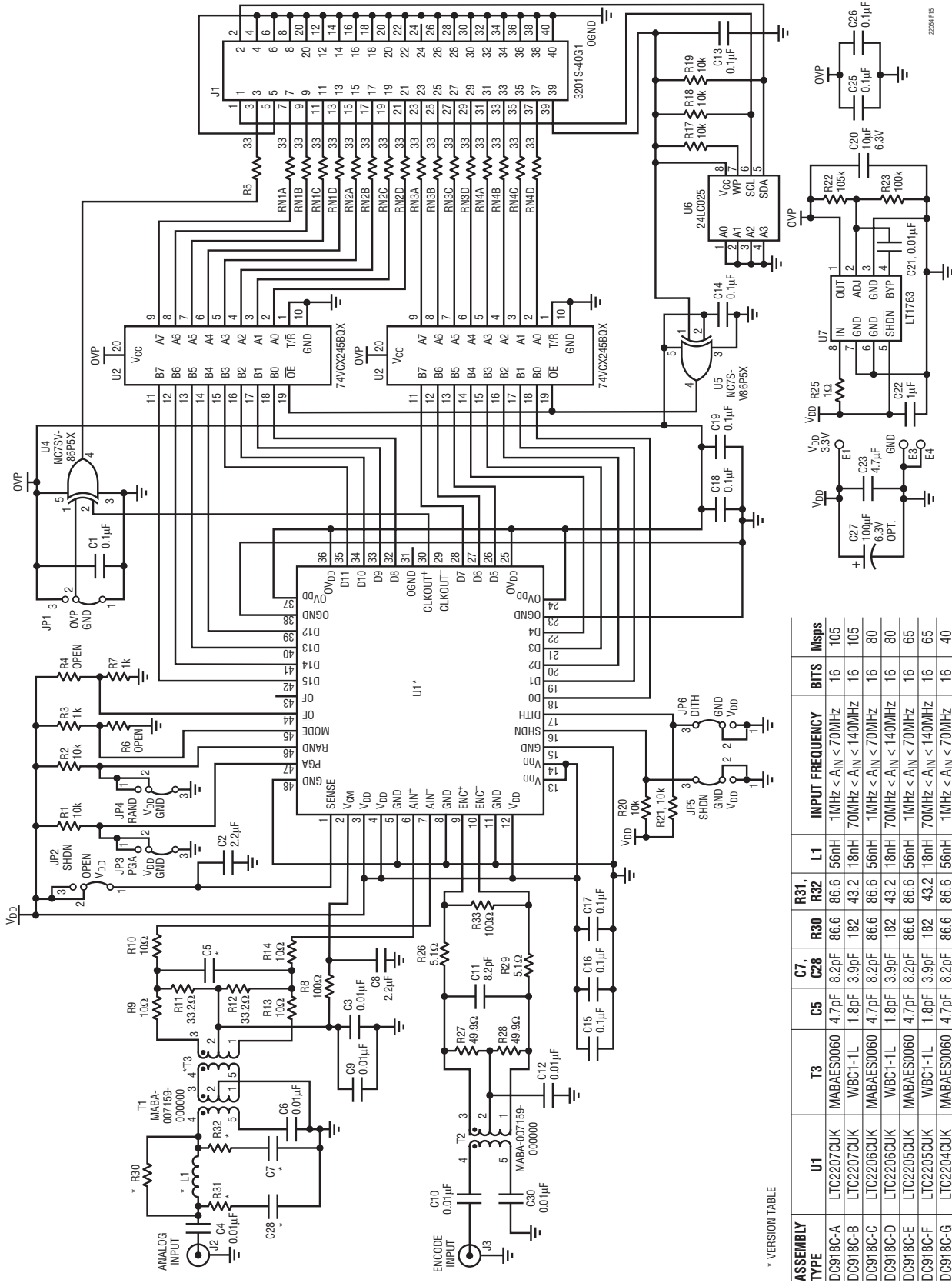

* VERSION TABLE

ASSEMBLY TYPE	U1	T3	C5	C7, C28	R30	R31, R32	L1	INPUT FREQUENCY	BITS	MSPS
DC918C-A	LTC2207CJUK	MABAES0060	4.7pF	8.2pF	86.6	86.6	56nH	1MHz < A _{IN} < 70MHz	16	105
DC918C-B	LTC2207CJUK	WBC1-1L	1.8pF	3.9pF	182	43.2	18nH	70MHz < A _{IN} < 140MHz	16	105
DC918C-C	LTC2206CJUK	MABAES0060	4.7pF	8.2pF	86.6	86.6	56nH	1MHz < A _{IN} < 70MHz	16	80
DC918C-D	LTC2206CJUK	WBC1-1L	1.8pF	3.9pF	182	43.2	18nH	70MHz < A _{IN} < 140MHz	16	80
DC918C-E	LTC2206CJUK	MABAES0060	4.7pF	8.2pF	86.6	86.6	56nH	1MHz < A _{IN} < 70MHz	16	65
DC918C-F	LTC2205CJUK	WBC1-1L	1.8pF	3.9pF	182	43.2	18nH	70MHz < A _{IN} < 140MHz	16	65
DC918C-G	LTC2204CJUK	MABAES0060	4.7pF	8.2pF	86.6	86.6	56nH	1MHz < A _{IN} < 70MHz	16	40
DC918C-H	LTC2207CJUK-14	MABAES0060	4.7pF	8.2pF	86.6	86.6	56nH	1MHz < A _{IN} < 70MHz	14	105
DC918C-I	LTC2207CJUK-14	WBC1-1L	1.8pF	3.9pF	182	43.2	18nH	70MHz < A _{IN} < 140MHz	14	105
DC918C-J	LTC2206CJUK-14	MABAES0060	4.7pF	8.2pF	86.6	86.6	56nH	1MHz < A _{IN} < 70MHz	14	80
DC918C-K	LTC2206CJUK-14	WBC1-1L	1.8pF	3.9pF	182	43.2	18nH	70MHz < A _{IN} < 140MHz	14	80
DC918C-L	LTC2205CJUK-14	MABAES0060	4.7pF	8.2pF	86.6	86.6	56nH	1MHz < A _{IN} < 70MHz	14	65

PACKAGE DESCRIPTION

UK Package
48-Lead Plastic QFN (7mm × 7mm)
 (Reference LTC DWG # 05-08-1704)

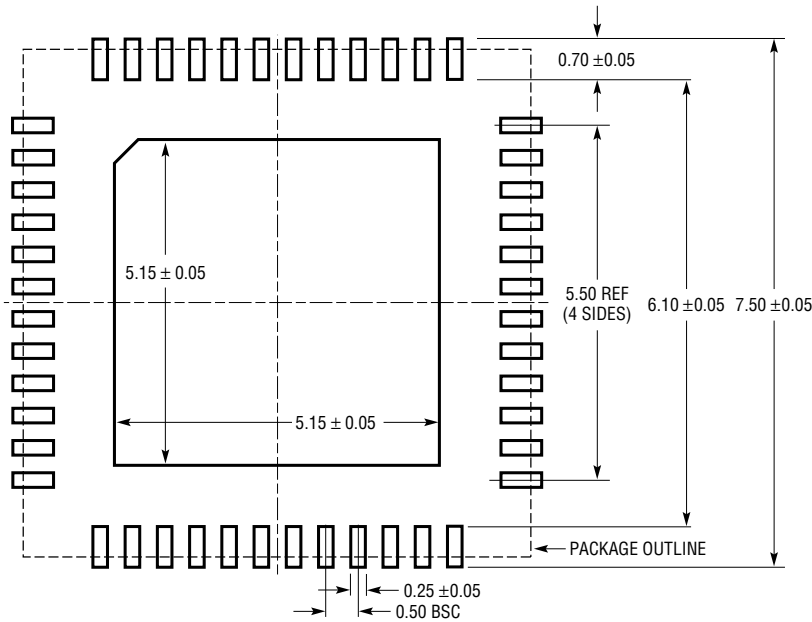

RECOMMENDED SOLDER PAD PITCH AND DIMENSIONS
 APPLY SOLDER MASK TO AREAS THAT ARE NOT SOLDERED

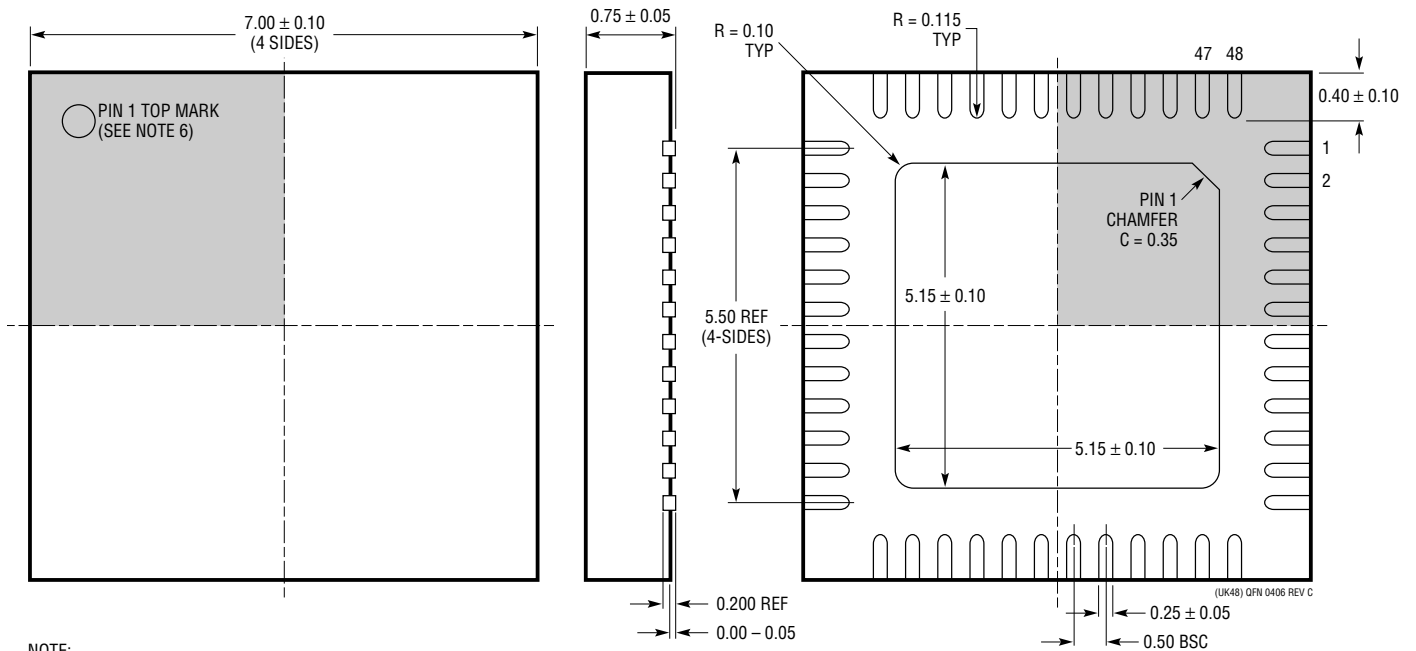

NOTE:

1. DRAWING CONFORMS TO JEDEC PACKAGE OUTLINE MO-220 VARIATION (WKKD-2)
2. DRAWING NOT TO SCALE
3. ALL DIMENSIONS ARE IN MILLIMETERS
4. DIMENSIONS OF EXPOSED PAD ON BOTTOM OF PACKAGE DO NOT INCLUDE MOLD FLASH. MOLD FLASH, IF PRESENT, SHALL NOT EXCEED 0.20mm ON ANY SIDE, IF PRESENT
5. EXPOSED PAD SHALL BE SOLDER PLATED
6. SHADED AREA IS ONLY A REFERENCE FOR PIN 1 LOCATION ON THE TOP AND BOTTOM OF PACKAGE

BOTTOM VIEW—EXPOSED PAD

LTC2205/LTC2204

RELATED PARTS

PART NUMBER	DESCRIPTION	COMMENTS
LTC1748	14-Bit, 80Msps 5V ADC	76.3dB SNR, 90dB SFDR, 48-Pin TSSOP Package
LTC1750	14-Bit, 80Msps, 5V Wideband ADC	Up to 500MHz IF Undersampling, 90dB SFDR
LT1993-2	High Speed Differential Op Amp	800MHz BW, 70dBc Distortion at 70MHz, 6dB Gain
LT1994	Low Noise, Low Distortion Fully Differential Input/Output Amplifier/Driver	Low Distortion: -94dBc at 1MHz
LTC2202	16-Bit, 10Msps, 3.3V ADC, Lowest Noise	140mW, 81.6dB SNR, 100dB SFDR, 48-Pin QFN
LTC2203	16-Bit, 25Msps, 3.3V ADC, Lowest Noise	220mW, 81.6dB SNR, 100dB SFDR, 48-Pin QFN
LTC2204	16-Bit, 40Msps, 3.3V ADC	480mW, 79.1dB SNR, 100dB SFDR, 48-Pin QFN
LTC2205	16-Bit, 65Msps, 3.3V ADC	610mW, 79dB SNR, 100dB SFDR, 48-Pin QFN
LTC2206	16-Bit, 80Msps, 3.3V ADC	725mW, 77.9dB SNR, 100dB SFDR, 48-Pin QFN
LTC2207	16-Bit, 105Msps, 3.3V ADC	900mW, 77.9dB SNR, 100dB SFDR, 48-Pin QFN
LTC2208	16-Bit, 130Msps, 3.3V ADC, LVDS Outputs	1250mW, 77.7dB SNR, 100dB SFDR, 64-Pin QFN
LTC2220-1	12-Bit, 185Msps, 3.3V ADC, LVDS Outputs	910mW, 67.7dB SNR, 80dB SFDR, 64-Pin QFN
LTC2224	12-Bit, 135Msps, 3.3V ADC, High IF Sampling	630mW, 67.6dB SNR, 84dB SFDR, 48-Pin QFN
LTC2255	14-Bit, 125Msps, 3V ADC, Lowest Power	395mW, 72.5dB SNR, 88dB SFDR, 32-Pin QFN
LTC2284	14-Bit, Dual, 105Msps, 3V ADC, Low Crosstalk	540mW, 72.4dB SNR, 88dB SFDR, 64-Pin QFN
LT5512	DC-3GHz High Signal Level Downconverting Mixer	DC to 3GHz, 21dBm IIP3, Integrated LO Buffer
LT5514	Ultralow Distortion IF Amplifier/ADC Driver with Digitally Controlled Gain	450MHz to 1dB BW, 47dB OIP3, Digital Gain Control 10.5dB to 33dB in 1.5dB/Step
LT5515	1.5GHz to 2.5GHz Direct Conversion Quadrature Demodulator	High IIP3: 20dBm at 1.9GHz, Integrated LO Quadrature Generator
LT5516	800MHz to 1.5GHz Direct Conversion Quadrature Demodulator	High IIP3: 21.5dBm at 900MHz, Integrated LO Quadrature Generator
LT5517	40MHz to 900MHz Direct Conversion Quadrature Demodulator	High IIP3: 21dBm at 800MHz, Integrated LO Quadrature Generator
LT5522	600MHz to 2.7GHz High Linearity Downconverting Mixer	4.5V to 5.25V Supply, 25dBm IIP3 at 900MHz. NF = 12.5dB, 50W Single-Ended RF and LO Ports