



ELECTRONICS

Product Information

ISSUE DATE : 2003-09-03

MODEL : LTM170EU-L11

Note : This Product information is subject to change after 3 months of issuing date

Prepared by AMLCD Technical Customer Service Team

Samsung Electronics Co . , LTD.

Contents

General Description	-----	(3)
1. Absolute Maximum Ratings	-----	(4)
1.1 Absolute ratings of environment		
1.2 Electrical Absolute Ratings		
2. Optical Characteristics	-----	(6)
3. Electrical Characteristics	-----	(9)
3.1 TFT LCD Module		
3.2 Back-light Unit		
4. Block Diagram	-----	(12)
4.1 TFT LCD Module		
4.2 Back-light Unit		
5. Input Terminal Pin Assignment	-----	(13)
5.1 Input Signal & Power		
5.2 LVDS Interface		
5.3 Back-light Unit		
5.4 Input Signals, Basic Display Colors and Gray Scale of Each Color		
6. Interface Timing	-----	(18)
6.1 Timing Parameters (DE only mode)		
6.2 Timing Diagrams of Interface Signal (DE only mode)		
6.3 Power ON/OFF Sequence		
7. Outline Dimension	-----	(21)
8. General Precaution	-----	(23)
8.1 Handling		
8.2 Storage		
8.3 Operation		
8.4 Others		

General Description

* Description

LTM170EU-L11 is a color active matrix TFT (Thin Film Transistor) liquid crystal display (LCD) that uses amorphous silicon TFTs as switching devices. This model is composed of a TFT LCD panel, a driver circuit and a back-light system. The resolution of a 17.0" contains 1280 x 1024 pixels and can display up to 16.2 millions colors.

* Features

- High contrast ratio, high aperture structure
- TN(Twisted Nematic) mode
- Wide viewing angle
- High speed response
- SXGA(1280 x 1024 pixels) resolution
- Low power consumption
- 2 dual CCFTs(Cold Cathode Fluorescent Tube)
- DE(Data Enable) mode
- LVDS (Low Voltage Differential Signaling) interface (2pixel/clock)
- COMPACT SIZE DESIGN

* Applications

Workstation & desktop monitors

Display terminals for AV application products

Monitors for industrial machine

* General information

Items	Specification	Unit	Note
Display area	337.92(H) x 270.336(V)	mm	
Driver element	a-Si TFT active matrix		
Display colors	16.2M	colors	
Number of pixels	1280 x 1024	pixel	
Pixel arrangement	RGB vertical stripe		
Pixel pitch	0.264(H) x 0.264(W)	mm	
Display mode	Normally White		
Surface treatment	Haze 25% , Hard-coating (3H)		

*** Mechanical information**

Item		Min.	Typ.	Max.	Note
Module size	Horizontal(H)	-	358.5	-	mm
	Vertical(V)	-	296.5	-	mm
	Depth(D)	-	-	17.5	mm
Weight		-	-	2,100	g

1. Absolute Maximum Ratings

1.1 Absolute ratings of environment

Item	Symbol	Min.	Max.	Unit	Note
Storage temperature	TSTG	-25	60	°C	(1)
Operating temperature (Glass surface temperature)	TOPR	0	50	°C	(1)
Shock (non - operating)	Snop	-	50	G	(2),(4)
Vibration (non - operating)	Vnop	-	1.5	G	(3),(4)

Note (1) Temperature and relative humidity range are shown in the figure below.

90 % RH Max. (40 °C ≥ Ta)

Maximum wet-bulb temperature at 39 °C or less. (Ta > 40 °C) No condensation.

(2) 11ms, sine wave, one time for ±X, ±Y, ±Z axis

(3) 10-300 Hz, Sweep rate 10min, 30min for X,Y,Z axis

(4) At vibration and shock test, the fixture which holds the module to be tested has to be hard and rigid enough so that the module would not be twisted or bent by the fixture.

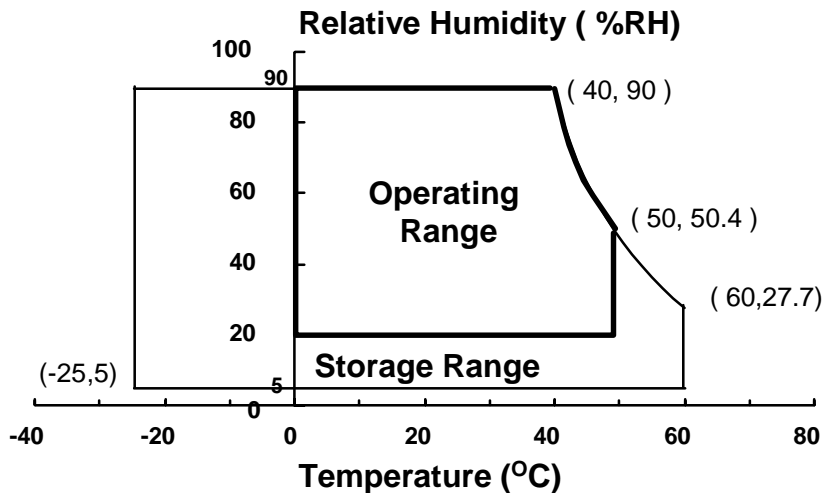

1.2 ELECTRICAL ABSOLUTE RATINGS

(1) TFT LCD Module

(V_{ss} = GND = 0 V)

Item	Symbol	Min.	Max.	Unit	Note
Power Supply Voltage	VDD	V _{ss} -0.5	6.5	V	(1)

NOTE (1) Within Ta (25 ± 2 °C)

(2) BACK-LIGHT UNIT

(Ta = 25 ± 2°C)

Item	Symbol	Min.	Max.	Unit.	Note
Lamp Current	IL	2.0	7.0	mArms	(1),(2)
Lamp Frequency	fL	40	80	kHz	(1)

NOTE

- (1) Permanent damage to the device may occur if maximum values are exceeded. Functional operation should be restricted to the conditions described under Normal Operating Conditions.
- (2) Specified values are for a single lamp (Refer to the Note (1) in the page 11 for further information).

2. Optical Characteristics

The following items are measured under stable conditions. The optical characteristics should be measured in a dark room or equivalent state with the methods shown in Note (1).

Measuring equipment : TOPCON BM-5A, BM-7, PHOTO RESEARCH PR650
Eldim EZ-Contrast

(Inverter Freq. : 50kHz) * Ta = 25 ± 2°C, VDD=5V, fv= 60Hz, fDCLK=54MHz, IL = 6.5mA_{rms}

Item	Symbol	Condition	Min.	Typ.	Max.	Unit	Note	
Contrast Ratio (Center of screen)	C/R	Normal $\phi = 0$ $\theta = 0$	-	500	-		(3) BM-5A	
Response Time	Rising		Tr	-	3	-	msec	(5) BM-7
	Falling		Tf	-	10	-		
Luminance of White (Center of screen)	YL			-	300	-	cd/m ²	(6) BM-5A
Color Chromaticity (CIE 1931)	Red	Rx	Viewing Angle	0.650	-	-	(7) PR650	
		Ry		0.330				
	Green	Gx		0.300				
		Gy		0.600				
	Blue	Bx		0.150				
		By		0.080				
	White	Wx		0.313				
		Wy		0.329				
Viewing Angle	Hor.	θ L	CR \geq 10	-	75	-	Degrees	(8) BM-5A
		θ R		-	75	-		
	Ver.	ϕ H		-	75	-		
		ϕ L		-	60	-		
Brightness Uniformity (9 Points)	Buni		-	-	25	%	(4) BM-5A	

Note 1) Test Equipment Setup

The measurement should be executed in a stable, windless and dark room between 30min and 40min after lighting the back-light at the given temperature for stabilization of the back-light. This should be measured in the center of screen.

Single lamp current : 6.5mA (Refer to the note(1) in the page 11 for more information.)

Environment condition : $T_a = 25 \pm 2 \text{ } ^\circ\text{C}$

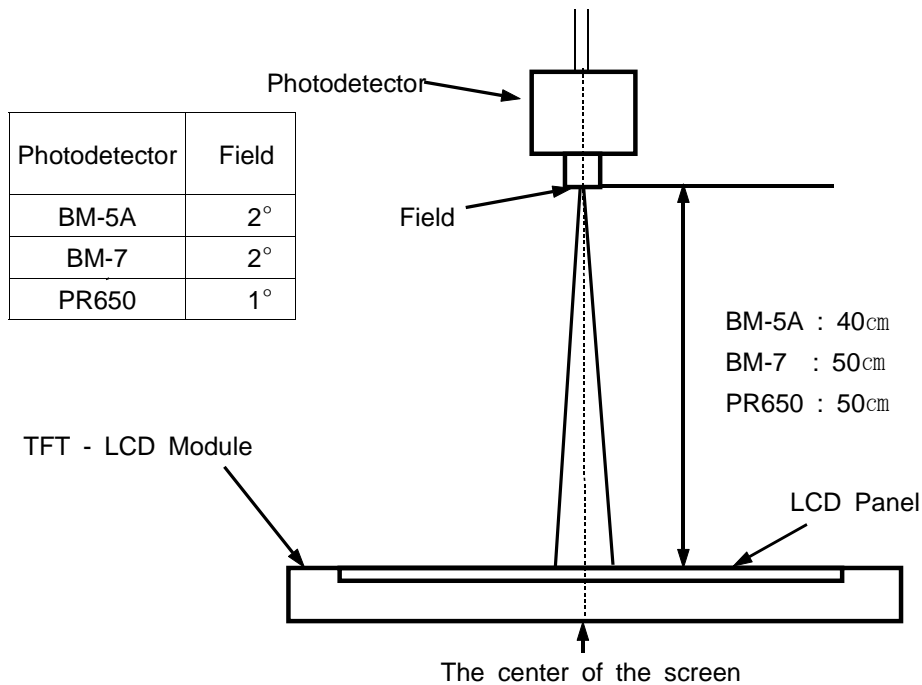

Optical Measuring Equipment Setup

Note 2) Definition of test point

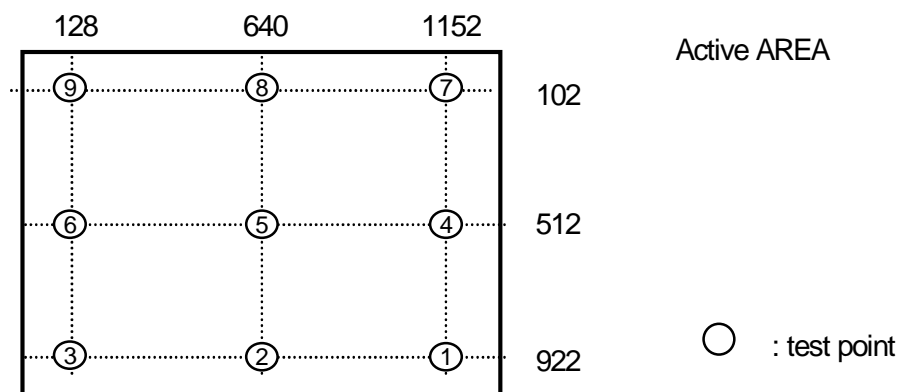

Note 3) Definition of Contrast Ratio (C/R) : Ratio of gray max (Gmax) & gray min (Gmin) at the center point⑤ of the panel

$$CR = \frac{G \text{ max}}{G \text{ min}}$$

Gmax : Luminance with all pixels white

Gmin : Luminance with all pixels black

Note 4) Definition of 9 points brightness uniformity

$$B_{uni} = 100 * \frac{(B_{max} - B_{min})}{B_{max}}$$

B_{max} : Maximum brightness

B_{min} : Minimum brightness

Note 5) Definition of Response time : Sum of Tr, Tf

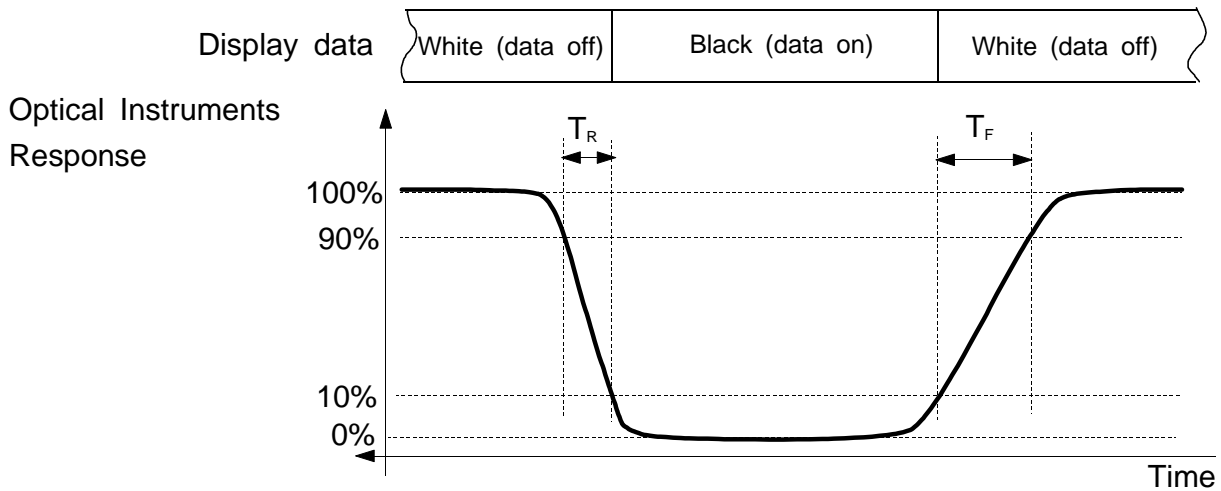

Note 6) Definition of Luminance of White : Luminance of white at center point^⑤.

Note 7) Definition of Color Chromaticity (CIE 1931)

Color coordinate of Red, Green, Blue & White at center point^⑤.

Note 8) Definition of Viewing Angle : Viewing angle range (CR ≥ 10)

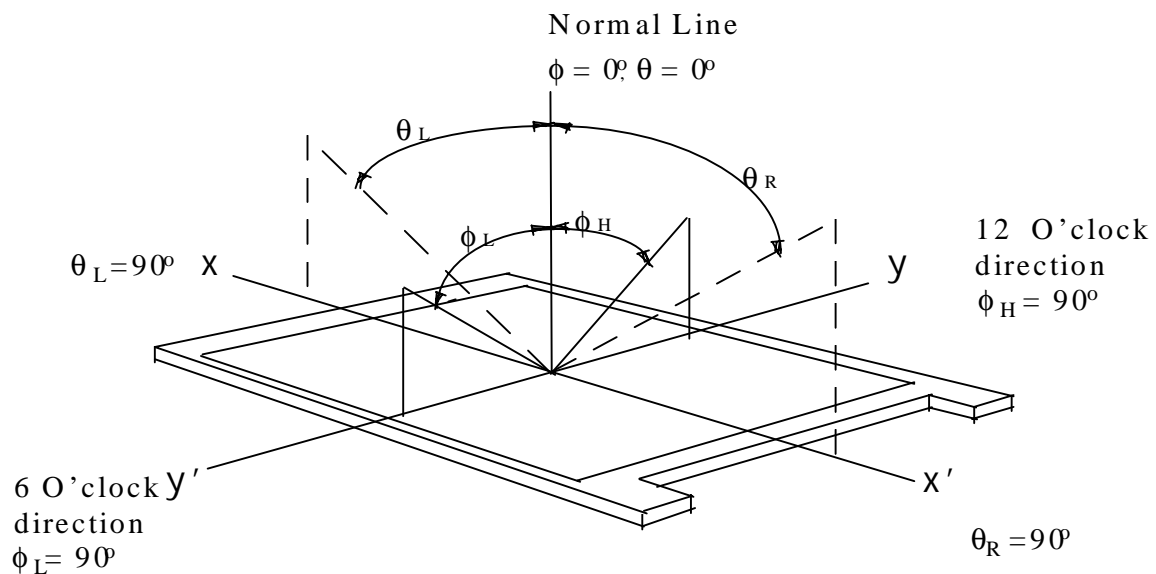

3. Electrical Characteristics

3.1 TFT LCD MODULE

Ta = 25°C

Item	Symbol	Min.	Typ.	Max.	Unit	Note
Voltage of Power Supply	V _{DD}	4.5	5.0	5.5	V	(1)
Interface type	LVDS	DS90C383/385		DS90C386 Pair		
Current of Power Supply	(a) Black	-	600	-	mA	(2),(3)
	(b) White	-	500	-	mA	
	(c) Dot	-	700	850	mA	
Vsync Frequency	f _V	55	60	77	Hz	
Hsync Frequency	f _H	56.7	64	82.082	kHz	
Main Frequency	f _{DCLK}	40	54	69.28	MHz	
Rush Current	I _{RUSH}	-	-	3.0	A	(4)

- Note
- (1) The connector for display data & timing signal should be connected.(V_{SS}=0V)
 - (2) f_V=60Hz, f_{DCLK} =54MHz, V_{DD} = 5.0V, DC Current.
 - (3) Power dissipation check pattern(LCD Module only)

a) Black Pattern

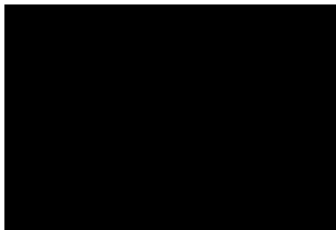

b) White Pattern

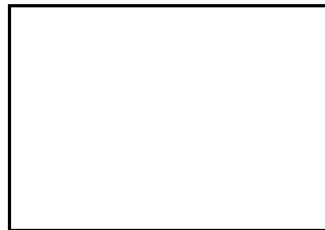

c) Dot Pattern

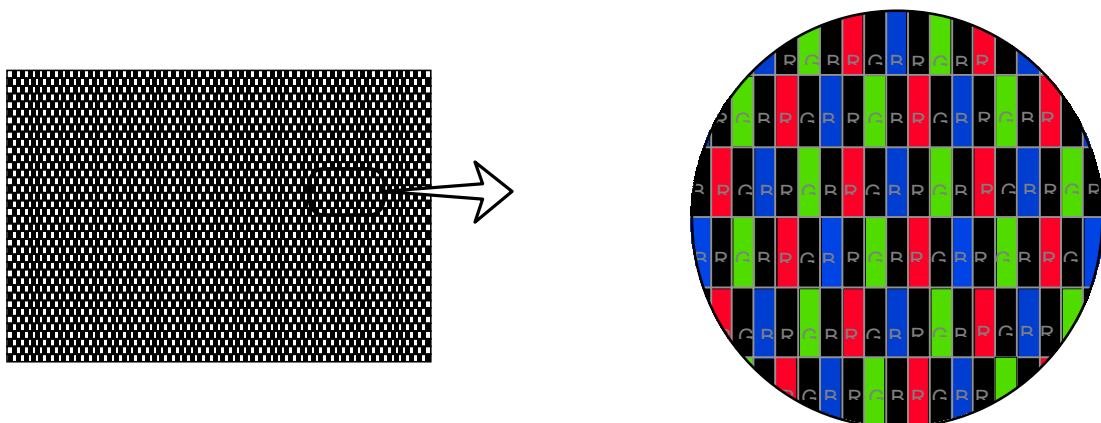

(4) Measurement Conditions

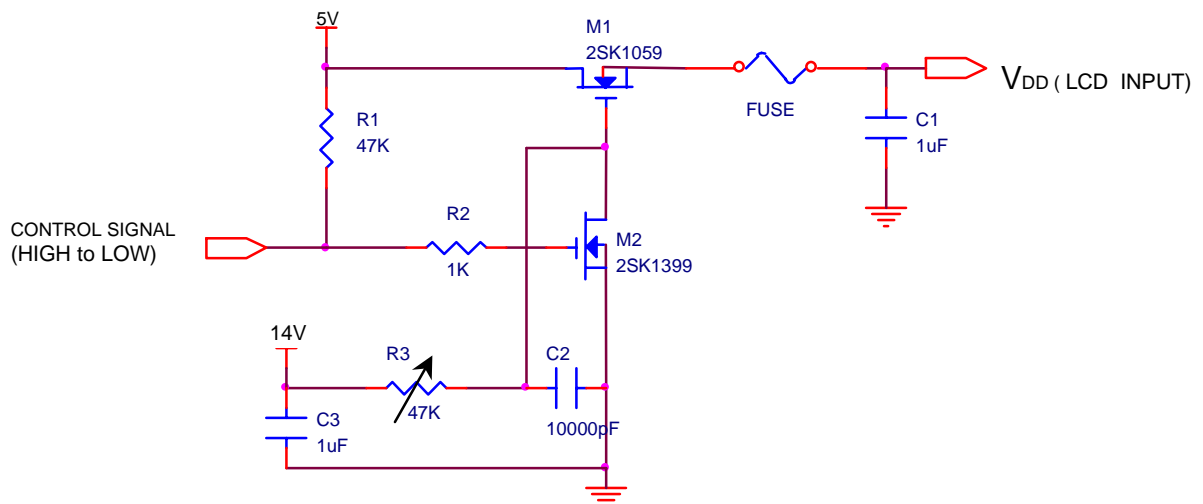

Note : Control Signal : High(+5V) -->Low(Ground)

All Signal lines to panel except for power 5V : Ground

The rising time of supplied voltage is controlled to 470us by R3 and C2 value.

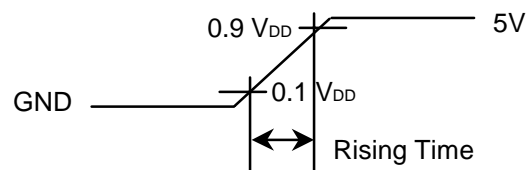

3.2 BACK-LIGHT UNIT

The back-light system is an edge - lighting type with 2 dual CCFTs (Cold Cathode Fluorescent Tube) The characteristics of two dual lamps are shown in the following tables.

Ta=25 ± 2°C

Item	Symbol	Min.	Typ.	Max.	Unit	Note
Lamp Current	IL	3.0	6.5	7.0	mArms	(1)
Lamp Voltage	VL	-	650	-	Vrms	
Lamp Frequency	fL	50	-	60	kHz	(2)
Startup Voltage	Vs	-	-	0°C : 1,800	Vrms	(3)
				25°C : 1,500		

Note) The waveform of the inverter output voltage must be area symmetric and the design of the inverter must have specifications for the modularized lamp.

The performance of the back-light, for example life time or brightness, is much influenced by the characteristics of the DC-AC inverter for the lamp. So all the parameters of an inverter should be carefully designed so as not to produce too much leakage current from high-voltage output of the inverter. When you design or order the inverter, please make sure that a poor lighting caused by the mismatch of the back-light and the inverter(miss lighting, flicker, etc.) never occur. When you confirm it, the module should be operated in the same condition as it is installed in your instrument.

Note (1) Lamp current is measured with current meter for high frequency as shown below.

Refer to the block diagram of the back-light unit in the next page for more information. Specified values are for a single lamp.

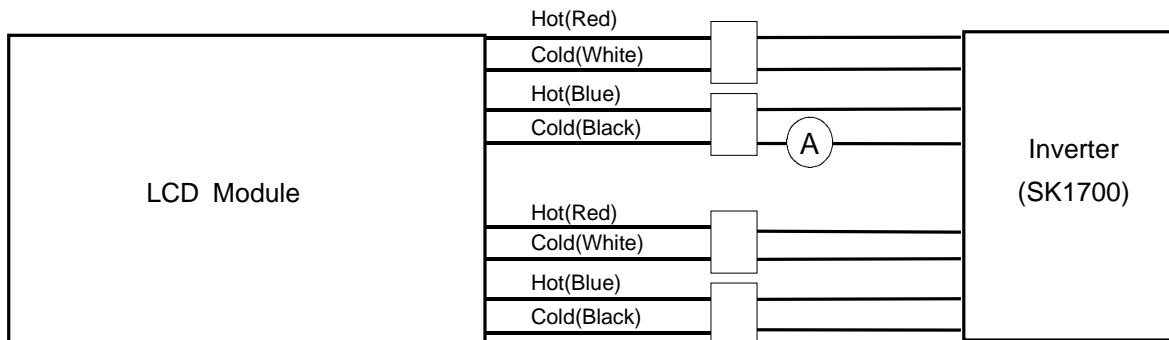

- (2) Lamp frequency may produce interference with horizontal synchronous frequency which may cause line flow on the display. Therefore lamp frequency should be detached from the horizontal synchronous frequency and its harmonics as far as possible in order to avoid interference.
- (3) If an inverter has shutdown function it should keep its output for more than 1 second even if the lamp connector open. Otherwise the lamps may not to be turned on.
- (4) Because the inverter uses high voltage, please disconnect it from the power before assembling or disassembling.

4. Block Diagram

4.1 TFT LCD MODULE

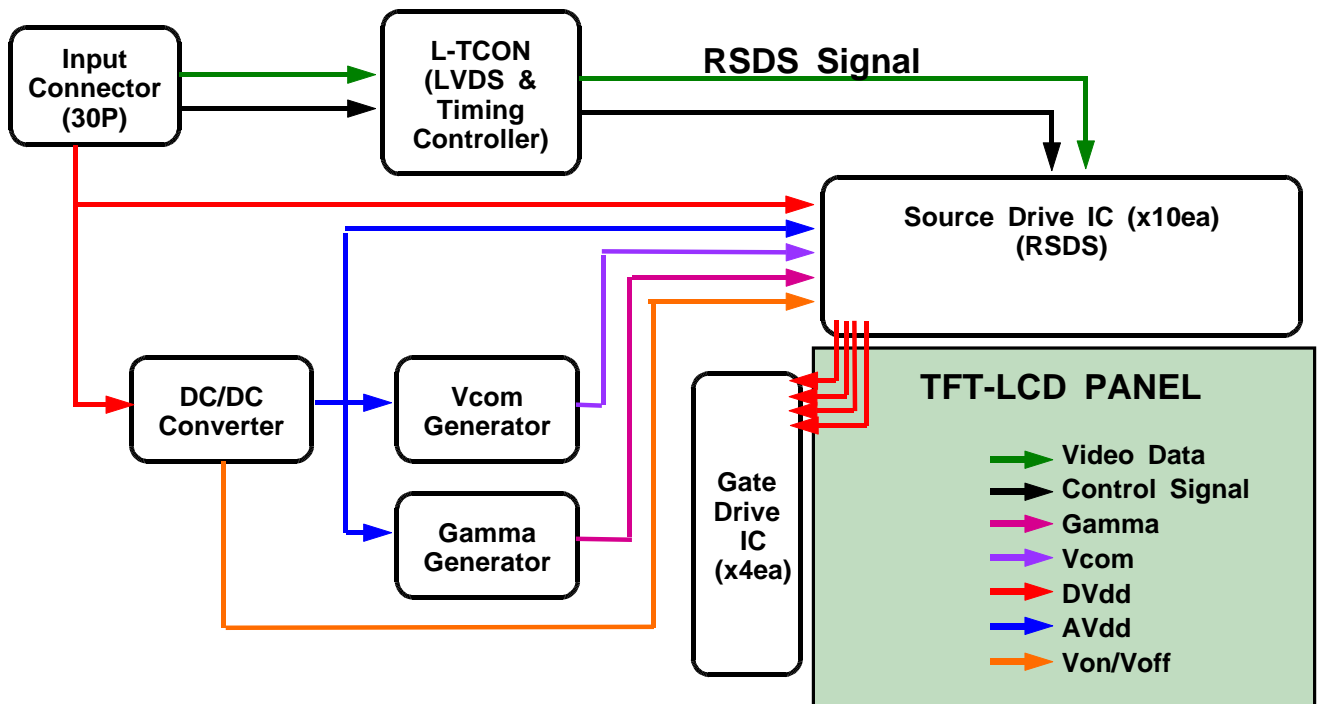

4.2 BACK-LIGHT UNIT

Connector : JST BHSR-02VS-1 or equivalent

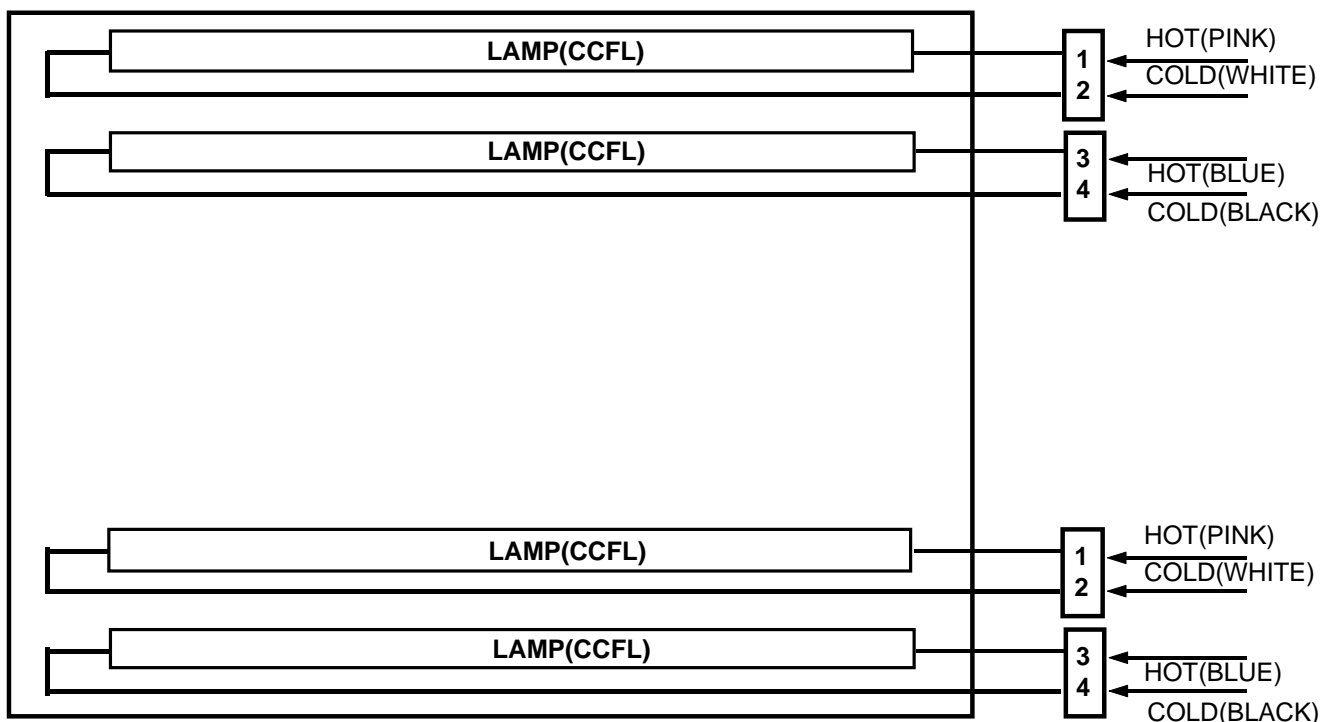

5. Input Terminal Pin Assignment

5.1. Input Signal & Power (Connector : FI-XB30SSL-HF15 or equivalent)

PIN NO	SYMBOL	FUNCTION
1	V _{DD}	Power Supply : +5V
2	V _{DD}	
3	V _{DD}	
4	NC	No Connection
5	NC	No Connection
6	NC	No Connection
7	GND	Power Ground
8	RXE3+	Positive Transmission Data of Pixel 3 (EVEN data)
9	RXE3-	Negative Transmission Data of Pixel 3 (EVEN data)
10	RXEC+	Positive Sampling Clock (EVEN data)
11	RXEC-	Negative Sampling Clock (EVEN data)
12	RXE2+	Positive Transmission Data of Pixel 2 (EVEN data)
13	RXE2-	Negative Transmission Data of Pixel 2 (EVEN data)
14	GND	Power Ground
15	RXE1+	Positive Transmission Data of Pixel 1 (EVEN data)
16	RXE1-	Negative Transmission Data of Pixel 1 (EVEN data)
17	GND	Power Ground
18	RXE0+	Positive Transmission Data of Pixel 0 (EVEN data)
19	RXE0-	Negative Transmission Data of Pixel 0 (EVEN data)
20	RXO3+	Positive Transmission Data of Pixel 3 (ODD data)
21	RXO3-	Negative Transmission Data of Pixel 3 (ODD data)
22	RXOC+	Positive Sampling Clock (ODD data)
23	RXOC-	Negative Sampling Clock (ODD data)
24	GND	Power Ground
25	RXO2+	Positive Transmission Data of Pixel 2 (ODD data)
26	RXO2-	Negative Transmission Data of Pixel 2 (ODD data)
27	RXO1+	Positive Transmission Data of Pixel 1 (ODD data)
28	RXO1-	Negative Transmission Data of Pixel 1 (ODD data)
29	RXO0+	Positive Transmission Data of Pixel 0 (ODD data)
30	RXO0-	Negative Transmission Data of Pixel 0 (ODD data)

Note) Start from Right side

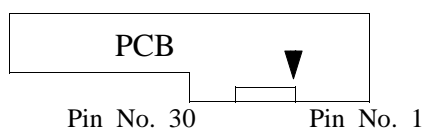

5.2 LVDS Interface

5.2.1 Odd pixel data (1st pixel data)

1st LVDS Transmitter (<i>DS90C383</i> , <i>DS90C385</i>) Signal Interface						
Device Input Pin		Device Input Signal		Output Signal	To LTM170EU Interface (CN101)	
No	Symbol	Symbol	Function		Terminal	Symbol
51	TXIN0	RO0	Red Odd Pixel Data (LSB)	TXOUT0- TXOUT0+	No. 1	RXO0-
52	TXIN1	RO1	Red Odd Pixel Data			
54	TXIN2	RO2	Red Odd Pixel Data		No. 2	RXO0+
55	TXIN3	RO3	Red Odd Pixel Data			
56	TXIN4	RO4	Red Odd Pixel Data			
2	TXIN5	RO7	Red Odd Pixel Data (MSB)	TXOUT3- TXOUT3+	No. 10	RXO3-
					No. 11	RXO3+
3	TXIN6	RO5	Red Odd Pixel Data	TXOUT0-	No. 1	RXO0-
4	TXIN7	GO0	Green Odd Pixel Data (LSB)	TXOUT0+	No. 2	RXO0+
6	TXIN8	GO1	Green Odd Pixel Data	TXOUT1-	No. 3	RXO1-
7	TXIN9	GO2	Green Odd Pixel Data	TXOUT1+	No. 4	RXO1+
8	TXIN10	GO6	Green Odd Pixel Data	TXOUT3-	No. 10	RXO3-
10	TXIN11	GO7	Green Odd Pixel Data (MSB)	TXOUT3+	No. 11	RXO3+
11	TXIN12	GO3	Green Odd Pixel Data	TXOUT1- TXOUT1+	No. 3	RXO1-
12	TXIN13	GO4	Green Odd Pixel Data			
14	TXIN14	GO5	Green Odd Pixel Data		No. 4	RXO1+
15	TXIN15	BO0	Blue Odd Pixel Data (LSB)			
16	TXIN16	BO6	Blue Odd Pixel Data	TXOUT3-	No. 10	RXO3-
18	TXIN17	BO7	Blue Odd Pixel Data (MSB)	TXOUT3+	No. 11	RXO3+
19	TXIN18	BO1	Blue Odd Pixel Data	TXOUT1- TXOUT1+	No. 3	RXO1-
					No. 4	RXO1+
20	TXIN19	BO2	Blue Odd Pixel Data	TXOUT2- TXOUT2+	No. 5	RXO2-
22	TXIN20	BO3	Blue Odd Pixel Data			
23	TXIN21	BO4	Blue Odd Pixel Data		No. 6	RXO2+
24	TXIN22	BO5	Blue Odd Pixel Data			
50	TXIN27	RO6	Red Odd Pixel Data	TXOUT3- TXOUT3+	No. 10	RXO3-
					No. 11	RXO3+

5.2.2 Even pixel data (2nd pixel data)

2nd LVDS Transmitter (<i>DS90C383</i> , <i>DS90C385</i>) Signal Interface						
Device Input Pin		Device Input Signal		Output Signal	To LTM170EU Interface (CN101)	
No	Symbol	Symbol	Function		Terminal	Symbol
51	TXIN0	RE0	Red Even Pixel Data (LSB)	TXOUT0- TXOUT0+	No. 12 No. 13	RXE0- RXE0+
52	TXIN1	RE1	Red Even Pixel Data			
54	TXIN2	RE2	Red Even Pixel Data			
55	TXIN3	RE3	Red Even Pixel Data			
56	TXIN4	RE4	Red Even Pixel Data			
2	TXIN5	RE7	Red Even Pixel Data (MSB)	TXOUT3- TXOUT3+	No. 22 No. 23	RXE3- RXE3+
3	TXIN6	RE5	Red Even Pixel Data	TXOUT0- TXOUT0+	No. 12 No. 13	RXE0- RXE0+
4	TXIN7	GE0	Green Even Pixel Data (LSB)			
6	TXIN8	GE1	Green Even Pixel Data	TXOUT1- TXOUT1+	No. 15 No. 16	RXE1- RXE1+
7	TXIN9	GE2	Green Even Pixel Data			
8	TXIN10	GE6	Green Even Pixel Data	TXOUT3- TXOUT3+	No. 22 No. 23	RXE3- RXE3+
10	TXIN11	GE7	Green Even Pixel Data (MSB)			
11	TXIN12	GE3	Green Even Pixel Data	TXOUT1- TXOUT1+	No. 15 No. 16	RXE1- RXE1+
12	TXIN13	GE4	Green Even Pixel Data			
14	TXIN14	GE5	Green Even Pixel Data			
15	TXIN15	BE0	Blue Even Pixel Data (LSB)			
16	TXIN16	BE6	Blue Even Pixel Data	TXOUT3- TXOUT3+	No. 22 No. 23	RXE3- RXE3+
18	TXIN17	BE7	Blue Even Pixel Data (MSB)			
19	TXIN18	BE1	Blue Even Pixel Data	TXOUT1- TXOUT1+	No. 15 No. 16	RXE1- RXE1+
20	TXIN19	BE2	Blue Even Pixel Data	TXOUT2- TXOUT2+	No. 18 No. 19	RXE2- RXE2+
22	TXIN20	BE3	Blue Even Pixel Data			
23	TXIN21	BE4	Blue Even Pixel Data			
24	TXIN22	BE5	Blue Even Pixel Data			
50	TXIN27	RE6	Red Even Pixel Data	TXOUT3- TXOUT3+	No. 22 No. 23	RXE3- RXE3+

5.3 BACK-LIGHT UNIT

	Pin No.	Input	Color	Function
Upper	1	Hot1	Pink	High Voltage
	2	Cold1	White	Ground
	3	Hot2	Blue	High Voltage
	4	Cold2	Black	Ground
Lower	1	Hot1	Pink	High Voltage
	2	Cold1	White	Ground
	3	Hot2	Blue	High Voltage
	4	Cold2	Black	Ground
	Connector Part No.	JST BHSR-02VS-1 or equivalent		

5.4 Input Signals, Basic Display Colors and Gray Scale of Each Color

COLOR	DISPLAY (8bit)	DATA SIGNAL																					GRAY SCALE LEVEL			
		RED							GREEN							BLUE										
		R0	R1	R2	R3	R4	R5	R6	R7	G0	G1	G2	G3	G4	G5	G6	G7	B0	B1	B2	B3	B4		B5	B6	B7
BASIC COLOR	BLACK	0	0	0	0	0	0	0	0	0	0	0	0	0	0	0	0	0	0	0	0	0	0	0	0	-
	BLUE	0	0	0	0	0	0	0	0	0	0	0	0	0	0	0	0	1	1	1	1	1	1	1	1	-
	GREEN	0	0	0	0	0	0	0	0	1	1	1	1	1	1	1	1	0	0	0	0	0	0	0	0	-
	CYAN	0	0	0	0	0	0	0	0	1	1	1	1	1	1	1	1	1	1	1	1	1	1	1	1	-
	RED	1	1	1	1	1	1	1	1	0	0	0	0	0	0	0	0	0	0	0	0	0	0	0	0	-
	MAGENTA	1	1	1	1	1	1	1	1	0	0	0	0	0	0	0	0	1	1	1	1	1	1	1	1	-
	YELLOW	1	1	1	1	1	1	1	1	1	1	1	1	1	1	1	1	0	0	0	0	0	0	0	0	-
	WHITE	1	1	1	1	1	1	1	1	1	1	1	1	1	1	1	1	1	1	1	1	1	1	1	1	-
GRAY SCALE OF RED	BLACK	0	0	0	0	0	0	0	0	0	0	0	0	0	0	0	0	0	0	0	0	0	0	0	R0	
	DARK ↑	0	0	0	0	0	0	0	0	0	0	0	0	0	0	0	0	0	0	0	0	0	0	0	R1	
		0	1	0	0	0	0	0	0	0	0	0	0	0	0	0	0	0	0	0	0	0	0	0	R2	
		:	:	:	:	:	:	:	:	:	:	:	:	:	:	:	:	:	:	:	:	:	:	:	:	R3~ R252
	LIGHT ↓	1	0	1	1	1	1	1	1	0	0	0	0	0	0	0	0	0	0	0	0	0	0	0	R252	
		0	1	1	1	1	1	1	1	0	0	0	0	0	0	0	0	0	0	0	0	0	0	0	R252	
		1	1	1	1	1	1	1	1	0	0	0	0	0	0	0	0	0	0	0	0	0	0	0	R252	
RED	1	1	1	1	1	1	1	1	0	0	0	0	0	0	0	0	0	0	0	0	0	0	0	R252		
GRAY SCALE OF GREEN	BLACK	0	0	0	0	0	0	0	0	0	0	0	0	0	0	0	0	0	0	0	0	0	0	0	G0	
	DARK ↑	0	0	0	0	0	0	0	0	1	0	0	0	0	0	0	0	0	0	0	0	0	0	0	G1	
		0	0	0	0	0	0	0	0	0	1	0	0	0	0	0	0	0	0	0	0	0	0	0	G2	
		:	:	:	:	:	:	:	:	:	:	:	:	:	:	:	:	:	:	:	:	:	:	:	G3~ G252	
	LIGHT ↓	0	0	0	0	0	0	0	0	1	0	1	1	1	1	1	1	0	0	0	0	0	0	0	G252	
		0	0	0	0	0	0	0	0	0	1	1	1	1	1	1	1	0	0	0	0	0	0	0	G252	
		0	0	0	0	0	0	0	0	1	1	1	1	1	1	1	1	0	0	0	0	0	0	0	G252	
GREEN	0	0	0	0	0	0	0	0	1	1	1	1	1	1	1	1	0	0	0	0	0	0	0	G252		
GRAY SCALE OF BLUE	BLACK	0	0	0	0	0	0	0	0	0	0	0	0	0	0	0	0	0	0	0	0	0	0	0	B0	
	DARK ↑	0	0	0	0	0	0	0	0	0	0	0	0	0	0	0	0	1	0	0	0	0	0	0	B1	
		0	0	0	0	0	0	0	0	0	0	0	0	0	0	0	0	0	1	0	0	0	0	0	B2	
		:	:	:	:	:	:	:	:	:	:	:	:	:	:	:	:	:	:	:	:	:	:	:	B3~ B252	
	LIGHT ↓	0	0	0	0	0	0	0	0	0	0	0	0	0	0	0	0	1	0	1	1	1	1	1	B252	
		0	0	0	0	0	0	0	0	0	0	0	0	0	0	0	0	0	1	1	1	1	1	1	B252	
		0	0	0	0	0	0	0	0	0	0	0	0	0	0	0	0	1	1	1	1	1	1	1	B252	
BLUE	0	0	0	0	0	0	0	0	0	0	0	0	0	0	0	0	1	1	1	1	1	1	1	B252		

Note) Definition of Gray :

Rn : Red Gray, Gn : Green Gray, Bn : Blue Gray (n = Gray level)

Input Signal : 0 = Low level voltage, 1 = High level voltage

6. Interface Timing

6.1 Timing Parameters (DE only mode)

SIGNAL	ITEM	SYMBOL	MIN.	TYP.	MAX.	UNIT	NOTE
Clock	Frequency	1/TC	40	54	69.28	MHz	(1), (2)
	High Time	TCH	4	-	-	nsec	
	Low Time	TCL	4	-	-	nsec	
Data	Setup Time	TDS	4	-	-	nsec	
	Hold Time	TDH	4	-	-	nsec	
Data Enable	Setup Time	TES	4	-	-	nsec	
Frame Frequency	Cycle	Tv	18.2	16.7	12.99	msec	
			1031	1066	-	lines	
	Frequency	1/Tv	55	60	77	Hz	(3)
Vertical Active Display Term	Display Period	TVD	1024	1024	1024	lines	
	Vertical Blank Period	TVB	8	-	-	lines	
One Line Scanning Time	Cycle	TH	752	844	1130	clocks	
Horizontal Active Display Term	Display Period	THD	640	640	640	clocks	

Note (1) Test Point : TTL control signal and CLK at LVDS Tx input terminal in system

(2) Internal Vcc = 3.3V

(3) At low Vsync frequency, under 60Hz, flicker level can increase at specific pattern.

6.2 Timing diagrams of interface signal (DE only mode)

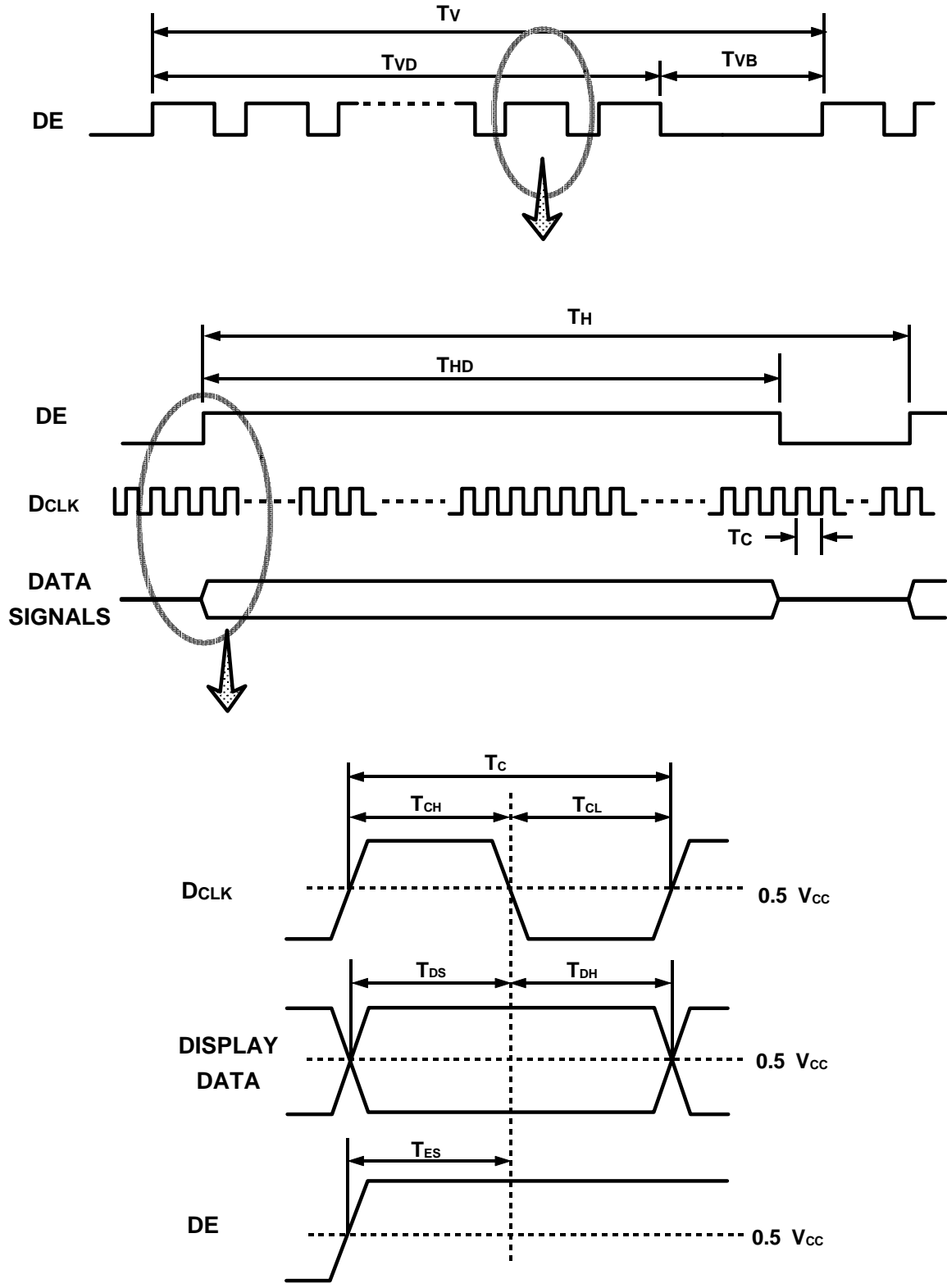

6.3 Power ON/OFF Sequence

: To prevent a latch-up or DC operation of the LCD module, the power on/off sequence should be as the diagram below.

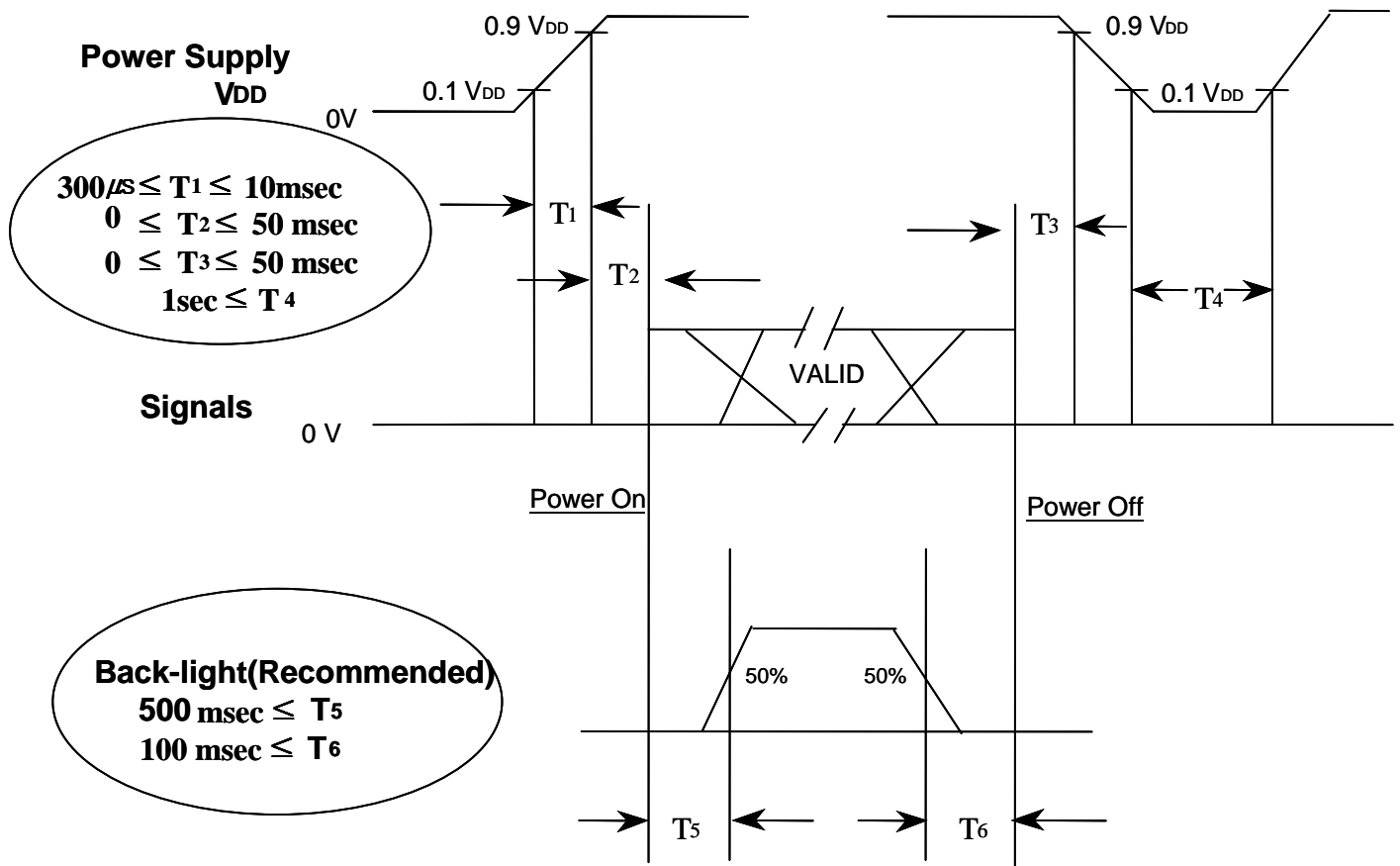

Power ON/OFF Sequence

NOTE.

- (1) The supply voltage of the external system for the module input should be the same as the definition of VDD.
- (2) Apply the lamp voltage within the LCD operation range. When the back-light turns on before the LCD operation or the LCD turns off before the back-light turns off, the display may momentarily become abnormal screen.
- (3) In case of VDD = off level, please keep the level of input signals low or keep a high impedance.
- (4) T4 should be measured after the module has been fully discharged between power off and on period.
- (5) Interface signal should not be kept at high impedance when the power is on.

7. Outline Dimension

[Refer to the next page]

NO	PART NAME	CODE NO	SPECIFICATION	Q'TY	WEIGHT	UNFOLDED DIM. OF MATERIAL	REMARK
----	-----------	---------	---------------	------	--------	---------------------------	--------

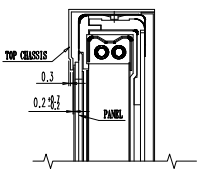
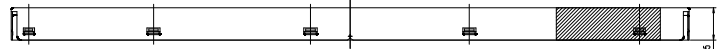
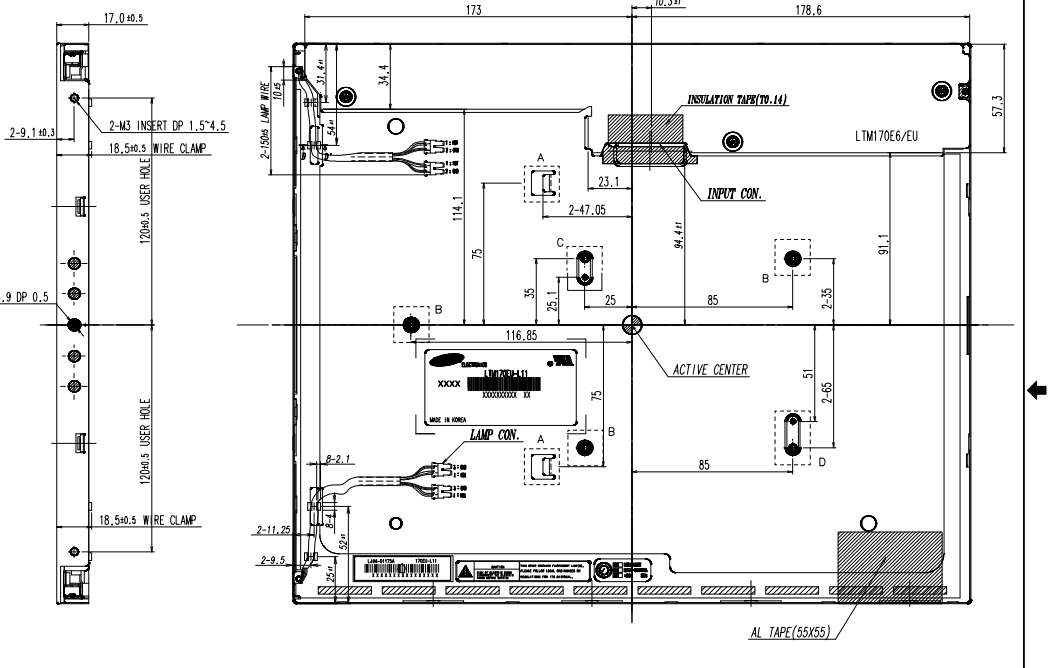
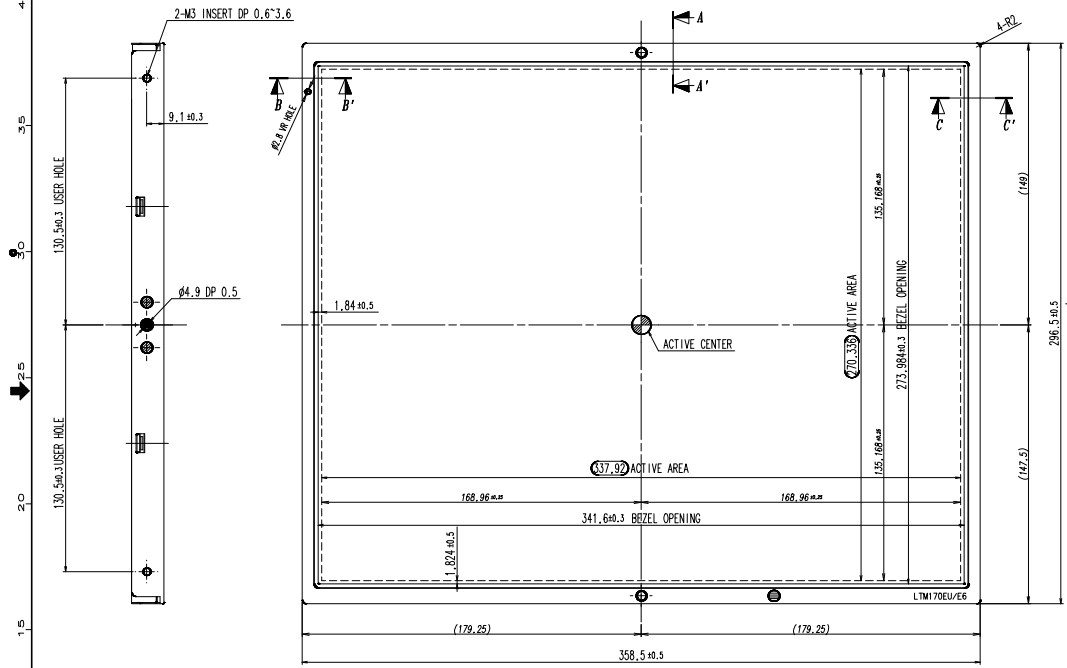
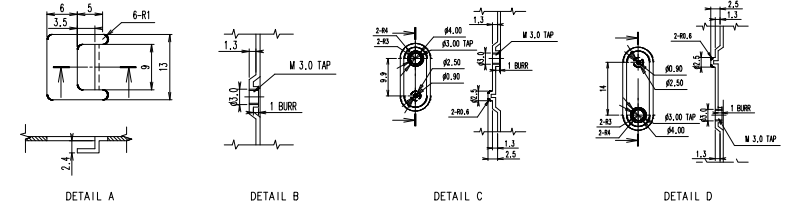
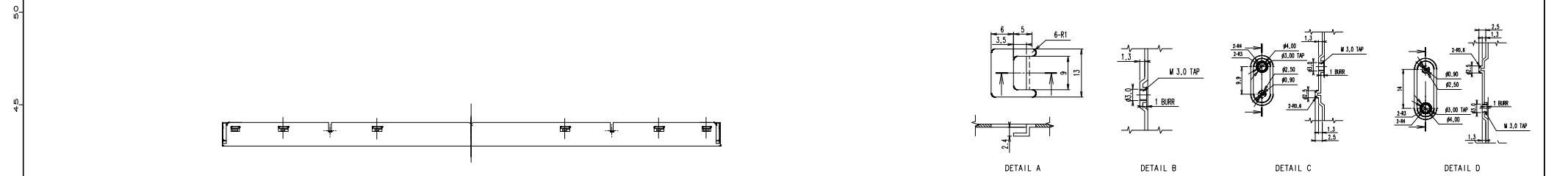

SEC. A-A'

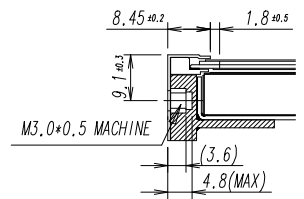

SEC. B-B'

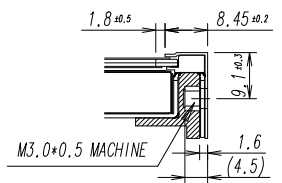

SEC. C-C'

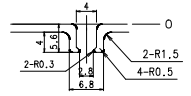

SEC. D-D'

- * NOTES**
- BACKLIGHT : 4 COLD CATHODE FLUORESCENT LAMPS.
 - I/F CONNECTOR SPECIFICATION.
- PART NO : JAE FI-XB30SSL-HF15
or Equivalent
 - LAMP CONNECTOR/WIRE SPECIFICATION.
- PART NO : JST BHSR-02VS-1(2 PIN x 150mm)
or Equivalent
 - ALLOWED DEPTH OF USERHOLE SCREW INSERTION IS 4.8MM MAX
 - USER MOUNTING TORQUE SPEC: 7kgf-Cm

GENERAL TOLERANCE				REV. DATE	DESCRIPTION OF REVISION			REASON	CHK'D BY
STEP	LEVEL 1	LEVEL 2	LEVEL 3	UNIT	DRN'N BY	DES'G BY	CHK'D BY	APP'D BY	MODEL NAME
0 < X ≤ 4	±0.05	±0.1	±0.2	mm	W. J. CHANG	Y. G. WUN	J. D. PARK		LTM170E6-L11
4 < X ≤ 16	±0.08	±0.15	±0.3	TOLERANCE					OUTLINE DIM.
16 < X ≤ 64	±0.12	±0.25	±0.5	LEVEL 3	03.06.13	03.06.13	03.06.13		
64 < X ≤ 256	±0.25	±0.4	±0.8	SPEC. NO					

SAMSUNG ELECTRONICS

CODE NO.	-	VER.	00
----------	---	------	----

20-00-01-TR1

8. General Precautions

8.1 Handling

- (a) When the module is assembled, it should be attached to the system firmly using all mounting holes. Be careful not to twist or bend the modules.
- (b) Because the inverter use high voltage, it should be disconnected from power before it is assembled or disassembled.
- (c) Refrain from strong mechanical shock and /or any force to the module.
In addition to damage, this may cause improper operation or damage to the module and CCFT back-light.
- (d) Note that polarizers are very fragile and could be easily damaged.
Do not press or scratch the surface using the harder than a HB pencil lead.
- (e) Wipe off water droplets or oil immediately.
If you leave the droplets for a long time, staining and discoloration may occur.
- (f) If the surface of the polarizer is dirty, clean it using some absorbent cotton or soft cloth.
- (g) The desirable cleaners are water, IPA(Isopropyl Alcohol) or Hexane.
Do not use Ketone type materials(ex. Acetone), Ethyl alcohol, Toluene, Ethyl acid or Methyl chloride. It might permanent damage to the polarizer due to chemical reaction.
- (h) If the liquid crystal material leaks from the panel, it should be kept away from the eyes or mouth. In case of contact with hands, legs or clothes, it must be washed away thoroughly with soap.
- (i) Protect the module from static which may cause damage to the CMOS Gate Array IC.
- (j) Use finger-stalls with soft gloves in order to keep display clean during the incoming inspection and assembly process.
- (k) Do not disassemble the module.
- (l) Do not pull or fold the lamp wire.
- (m) Do not adjust the variable resistor located on the module.
- (n) Protection film for polarizer on the module should be slowly peeled off just before use so that the electrostatic charge can be minimized.
- (o) Pins of I/F connector should not be touched directly with bare hands.

8.2 Storage

- (a) Do not leave the module in high temperature, high humidity for a long time.
It is highly recommended to store the module with temperature from 0 to 35 °C and relative humidity of less than 70%.
- (b) Do not store the TFT-LCD module in direct sunlight.
- (c) The module should be stored in a dark place.
It is prohibited to apply sunlight or fluorescent light in storage.

8.3 Operation

- (a) Do not connect or disconnect the module in the "Power On" condition.
- (b) Power supply should always be turned on/off by 6.3 "Power on/off sequence"
- (c) Module has high frequency circuits. Sufficient suppression to the electromagnetic interference should be done by system manufacturers. Grounding and shielding methods may be important to minimize the interference.
- (d) The cable between the back-light connector and its inverter power supply should be connected directly with a minimized length. A longer cable between the back-light and the inverter may cause lower luminance of lamp(CCFT) and may require higher startup voltage(Vs).

8.4 Others

- (a) Ultra-violet ray filter is necessary for outdoor operation.
- (b) Avoid condensation of water which may result in improper operation or disconnection of electrode.
- (c) Do not exceed the absolute maximum rating value. (supply voltage variation, input voltage variation, variation in part contents and environmental temperature, and so on)
Otherwise the module may be damaged.
- (d) If the module keeps displaying the same pattern for a long period of time, the image may be "sticked" to the screen.
- (e) This module has its circuitry PCB's on the rear side and should be handled carefully in order not to be stressed.