

# HM62W16258B Series

4 M SRAM (256-kword × 16-bit)

# HITACHI

ADE-203-976B (Z)

Rev. 2.0

Oct. 14, 1999

## Description

The Hitachi HM62W16258B Series is 4-Mbit static RAM organized 262,144-word × 16-bit. HM62W16258B Series has realized higher density, higher performance and low power consumption by employing Hi-CMOS process technology. It offers low power standby power dissipation; therefore, it is suitable for battery backup systems. It is packaged in standard 44-pin plastic TSOPII.

## Features

- Single 3.3 V supply: 3.3 V ± 0.3 V
- Fast access time: 55 ns/70 ns (max)
- Power dissipation:
  - Active: 9.9 mW (typ)
  - Standby: 3.3 μW (typ)
- Completely static memory.
  - No clock or timing strobe required
- Equal access and cycle times
- Common data input and output.
  - Three state output
- Battery backup operation.



---

## HM62W16258B Series

---

### Ordering Information

Type No.	Access time	Package
HM62W16258BLTT-5	55 ns	400-mil 44-pin plastic TSOPII (normal-bend type) (TTP-44DB)
HM62W16258BLTT-7	70 ns	
HM62W16258BLTT-5SL	55 ns	
HM62W16258BLTT-7SL	70 ns	

---

**Pin Arrangement**

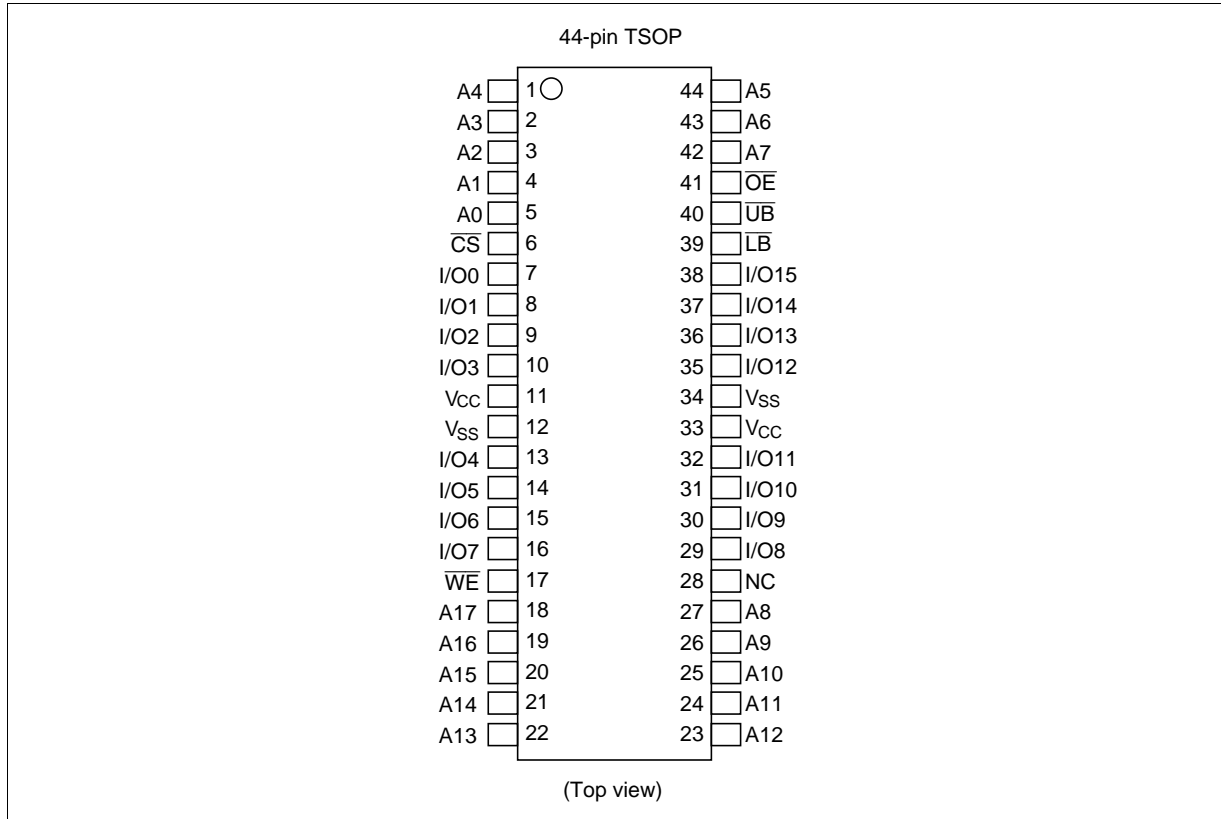

**Pin Description**

Pin name	Function
A0 to A17	Address input
I/O0 to I/O15	Data input/output
$\overline{CS}$	Chip select
$\overline{WE}$	Write enable
$\overline{OE}$	Output enable
$\overline{LB}$	Lower byte select
$\overline{UB}$	Upper byte select
V <sub>CC</sub>	Power supply
V <sub>SS</sub>	Ground
NC	No connection

# HM62W16258B Series

## Block Diagram

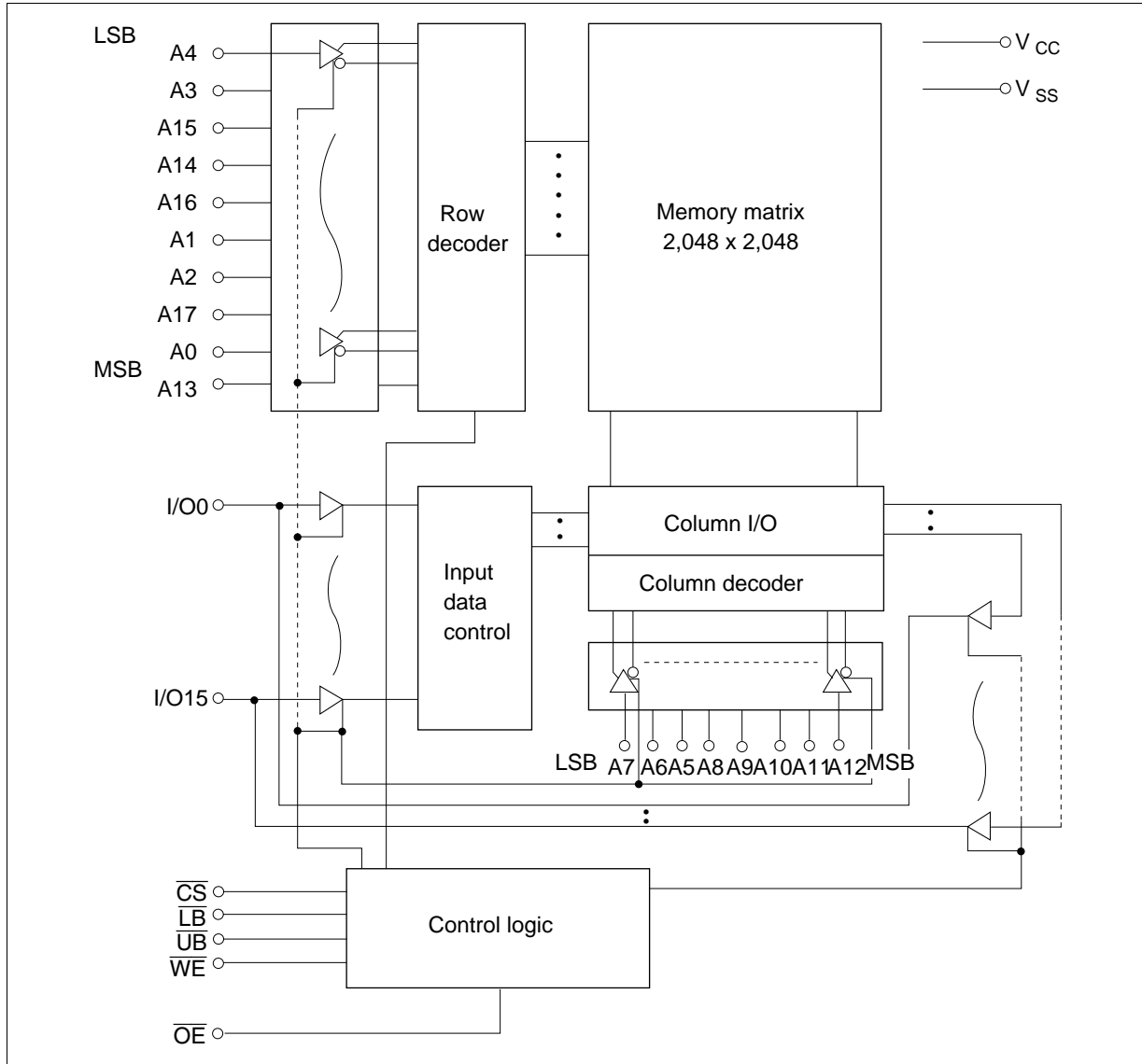

**Operation Table**

$\overline{CS}$	$\overline{WE}$	$\overline{OE}$	$\overline{UB}$	$\overline{LB}$	I/O0 to I/O7	I/O8 to I/O15	Operation
H	×	×	×	×	High-Z	High-Z	Standby
×	×	×	H	H	High-Z	High-Z	Standby
L	H	L	L	L	Dout	Dout	Read
L	H	L	H	L	Dout	High-Z	Lower byte read
L	H	L	L	H	High-Z	Dout	Upper byte read
L	L	×	L	L	Din	Din	write
L	L	×	H	L	Din	High-Z	Lower byte write
L	L	×	L	H	High-Z	Din	Upper byte write
L	H	H	×	×	High-Z	High-Z	Output disable

Note: H:  $V_{IH}$ , L:  $V_{IL}$ , ×:  $V_{IH}$  or  $V_{IL}$

**Absolute Maximum Ratings**

Parameter	Symbol	Value	Unit
Power supply voltage relative to $V_{SS}$	$V_{CC}$	-0.5 to + 4.6	V
Terminal voltage on any pin relative to $V_{SS}$	$V_T$	-0.5* <sup>1</sup> to $V_{CC} + 0.3$ * <sup>2</sup>	V
Power dissipation	$P_T$	1.0	W
Storage temperature range	Tstg	-55 to +125	°C
Storage temperature range under bias	Tbias	-10 to +85	°C

Notes: 1.  $V_T$  min: -3.0 V for pulse half-width  $\leq$  30 ns.  
 2. Maximum voltage is +4.6 V.

**DC Operating Conditions**

Parameter	Symbol	Min	Typ	Max	Unit	Note
Supply voltage	$V_{CC}$	3.0	3.3	3.6	V	
	$V_{SS}$	0	0	0	V	
Input high voltage	$V_{IH}$	2.0	—	$V_{CC} + 0.3$	V	
Input low voltage	$V_{IL}$	-0.3	—	0.8	V	1
Ambient temperature range	$T_a$	0	—	70	°C	

Note: 1.  $V_{IL}$  min: -3.0 V for pulse half-width  $\leq$  30 ns.

## HM62W16258B Series

### DC Characteristics

Parameter	Symbol	Min	Typ* <sup>1</sup>	Max	Unit	Test conditions
Input leakage current	$ I_{LI} $	—	—	1	$\mu\text{A}$	$V_{in} = V_{SS}$ to $V_{CC}$
Output leakage current	$ I_{LO} $	—	—	1	$\mu\text{A}$	$\overline{CS} = V_{IH}$ or $\overline{OE} = V_{IH}$ or $\overline{WE} = V_{IL}$ , or $\overline{LB} = \overline{UB} = V_{IH}$ , $V_{I/O} = V_{SS}$ to $V_{CC}$
Operating current	$I_{CC}$	—	—	20	$\text{mA}$	$\overline{CS} = V_{IL}$ , Others = $V_{IH}/V_{IL}$ , $I_{I/O} = 0 \text{ mA}$
Average operating current	HM62W16258B-5 $I_{CC1}$	—	—	80	$\text{mA}$	Min. cycle, duty = 100%, $I_{I/O} = 0 \text{ mA}$ , $\overline{CS} = V_{IL}$ , Others = $V_{IH}/V_{IL}$
	HM62W16258B-7 $I_{CC1}$	—	—	70	$\text{mA}$	
	$I_{CC2}$	—	3	15	$\text{mA}$	Cycle time = 1 $\mu\text{s}$ , duty = 100%, $I_{I/O} = 0 \text{ mA}$ , $\overline{CS} \leq 0.2 \text{ V}$ , $V_{IH} \geq V_{CC} - 0.2 \text{ V}$ , $V_{IL} \leq 0.2 \text{ V}$
Standby current	$I_{SB}$	—	—	0.3	$\text{mA}$	$\overline{CS} = V_{IH}$
Standby current	$I_{SB1}^{*2}$	—	1	40	$\mu\text{A}$	$0 \text{ V} \leq V_{in}$ $\overline{CS} \geq V_{CC} - 0.2 \text{ V}$
	$I_{SB1}^{*3}$	—	1	20	$\mu\text{A}$	
Output high voltage	$V_{OH}$	2.4	—	—	$\text{V}$	$I_{OH} = -1 \text{ mA}$
		$V_{CC} - 0.2$	—	—	$\text{V}$	$I_{OH} = -100 \mu\text{A}$
Output low voltage	$V_{OL}$	—	—	0.4	$\text{V}$	$I_{OL} = 2 \text{ mA}$
		—	—	0.2	$\text{V}$	$I_{OL} = 100 \mu\text{A}$

Notes: 1. Typical values are at  $V_{CC} = 3.0 \text{ V}$ ,  $T_a = +25^\circ\text{C}$  and not guaranteed.

2. This characteristic is guaranteed only for L-version.

3. This characteristic is guaranteed only for L-SL version.

### Capacitance ( $T_a = +25^\circ\text{C}$ , $f = 1.0 \text{ MHz}$ )

Parameter	Symbol	Min	Typ	Max	Unit	Test conditions	Note
Input capacitance	$C_{in}$	—	—	8	$\text{pF}$	$V_{in} = 0 \text{ V}$	1
Input/output capacitance	$C_{I/O}$	—	—	10	$\text{pF}$	$V_{I/O} = 0 \text{ V}$	1

Note: 1. This parameter is sampled and not 100% tested.

## HM62W16258B Series

**AC Characteristics** ( $T_a = 0$  to  $+70^\circ\text{C}$ ,  $V_{CC} = 3.3\text{ V} \pm 0.3\text{ V}$ , unless otherwise noted.)

### Test Conditions

- Input pulse levels:  $V_{IL} = 0.4\text{ V}$ ,  $V_{IH} = 2.4\text{ V}$
- Input rise and fall time:  $5\text{ ns}$
- Input timing reference levels:  $1.4\text{ V}$
- Output timing reference levels:  $1.4\text{ V}/1.4\text{ V}$  (HM62W16258B-5)  
:  $2.0\text{ V}/0.8\text{ V}$  (HM62W16258B-7)
- Output load (Including scope and jig)

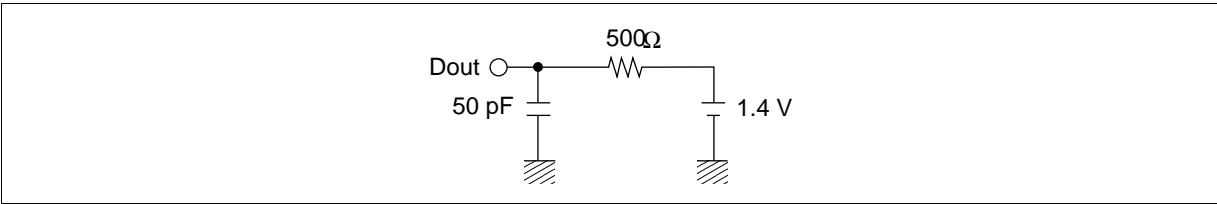

### Read Cycle

Parameter	Symbol	HM62W16258B				Unit	Notes
		-5		-7			
		Min	Max	Min	Max		
Read cycle time	$t_{RC}$	55	—	70	—	ns	
Address access time	$t_{AA}$	—	55	—	70	ns	
Chip select access time	$t_{ACS}$	—	55	—	70	ns	
Output enable to output valid	$t_{OE}$	—	35	—	40	ns	
Output hold from address change	$t_{OH}$	10	—	10	—	ns	
$\overline{LB}$ , $\overline{UB}$ access time	$t_{BA}$	—	55	—	70	ns	
Chip select to output in low-Z	$t_{CLZ}$	10	—	10	—	ns	2, 3
$\overline{LB}$ , $\overline{UB}$ enable to low-z	$t_{BLZ}$	5	—	5	—	ns	2, 3
Output enable to output in low-Z	$t_{OLZ}$	5	—	5	—	ns	2, 3
Chip deselect to output in high-Z	$t_{CHZ}$	0	20	0	25	ns	1, 2, 3
$\overline{LB}$ , $\overline{UB}$ disable to high-Z	$t_{BHZ}$	0	20	0	25	ns	1, 2, 3
Output disable to output in high-Z	$t_{OHZ}$	0	20	0	25	ns	1, 2, 3

## HM62W16258B Series

### Write Cycle

Parameter	Symbol	HM62W16258B				Unit	Notes
		-5		-7			
		Min	Max	Min	Max		
Write cycle time	$t_{WC}$	55	—	70	—	ns	
Address valid to end of write	$t_{AW}$	50	—	60	—	ns	
Chip selection to end of write	$t_{CW}$	50	—	60	—	ns	5
Write pulse width	$t_{WP}$	40	—	50	—	ns	4
$\overline{LB}$ , $\overline{UB}$ valid to end of write	$t_{BW}$	50	—	55	—	ns	
Address setup time	$t_{AS}$	0	—	0	—	ns	6
Write recovery time	$t_{WR}$	0	—	0	—	ns	7
Data to write time overlap	$t_{DW}$	25	—	30	—	ns	
Data hold from write time	$t_{DH}$	0	—	0	—	ns	
Output active from end of write	$t_{OW}$	5	—	5	—	ns	2
Output disable to output in High-Z	$t_{OHZ}$	0	20	0	25	ns	1, 2
Write to output in high-Z	$t_{WHZ}$	0	20	0	25	ns	1, 2

- Notes:
- $t_{CHZ}$ ,  $t_{OHZ}$ ,  $t_{WHZ}$  and  $t_{BHZ}$  are defined as the time at which the outputs achieve the open circuit conditions and are not referred to output voltage levels.
  - This parameter is sampled and not 100% tested.
  - At any given temperature and voltage condition,  $t_{HZ}$  max is less than  $t_{LZ}$  min both for a given device and from device to device.
  - A write occurs during the overlap of a low  $\overline{CS}$ , a low  $\overline{WE}$  and a low  $\overline{LB}$  or a low  $\overline{UB}$ . A write begins at the latest transition among  $\overline{CS}$  going low,  $\overline{WE}$  going low and  $\overline{LB}$  going low or  $\overline{UB}$  going low. A write ends at the earliest transition among  $\overline{CS}$  going high,  $\overline{WE}$  going high and  $\overline{LB}$  going high or  $\overline{UB}$  going high.  $t_{WP}$  is measured from the beginning of write to the end of write.
  - $t_{CW}$  is measured from the later of  $\overline{CS}$  going low to the end of write.
  - $t_{AS}$  is measured from the address valid to the beginning of write.
  - $t_{WR}$  is measured from the earliest of  $\overline{CS}$  or  $\overline{WE}$  going high to the end of write cycle.



Timing Waveform

Read Cycle

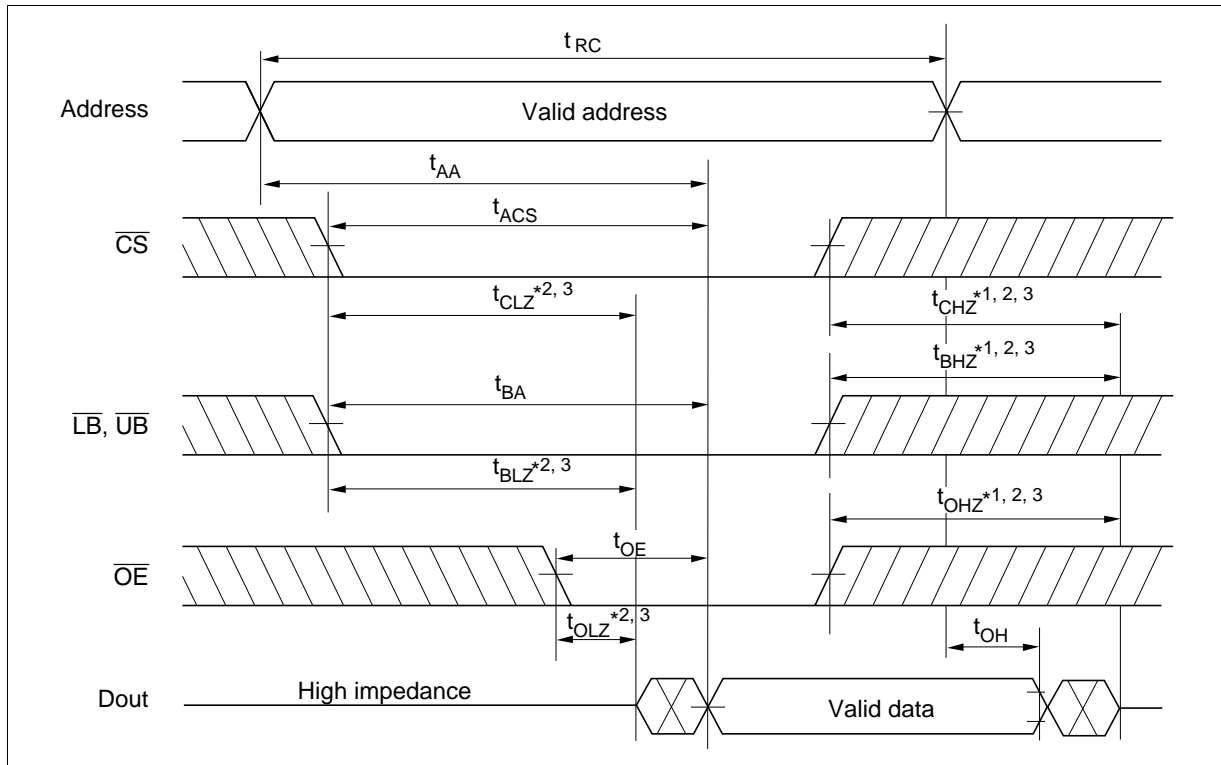

# HM62W16258B Series

## Write Cycle (1) ( $\overline{\text{WE}}$ Clock)

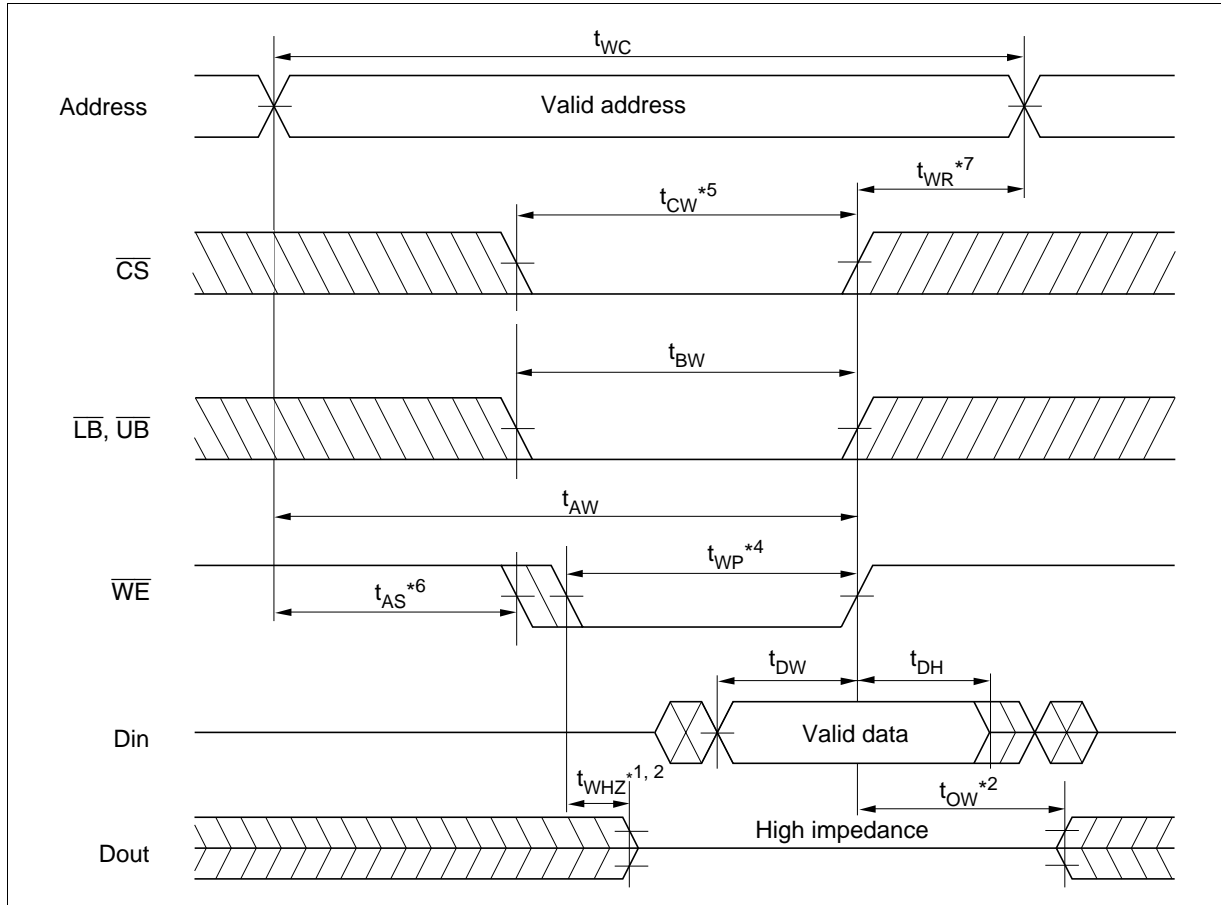

Write Cycle (2) ( $\overline{CS}$  Clock,  $\overline{OE} = V_{IH}$ )

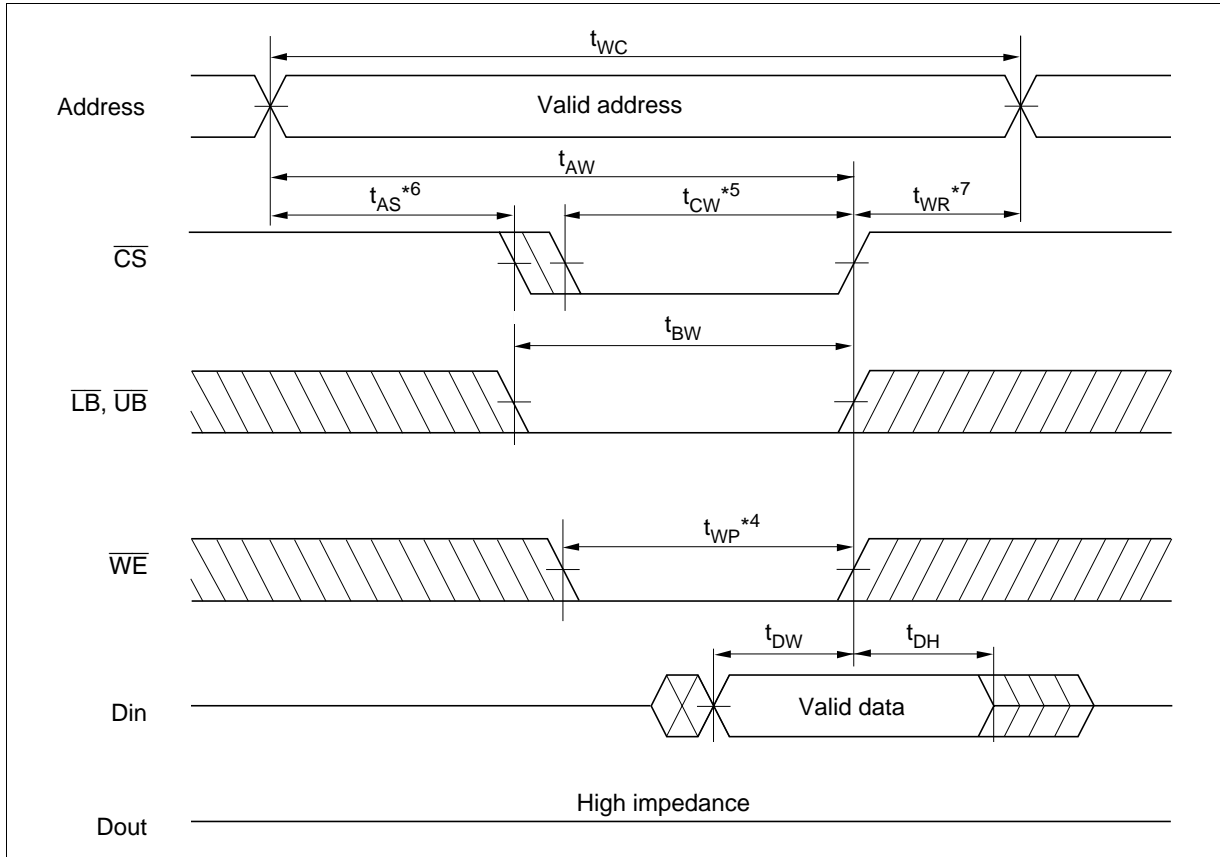

## HM62W16258B Series

Write Cycle (3) ( $\overline{\text{LB}}$ ,  $\overline{\text{UB}}$  Clock,  $\overline{\text{OE}} = V_{\text{IH}}$ )

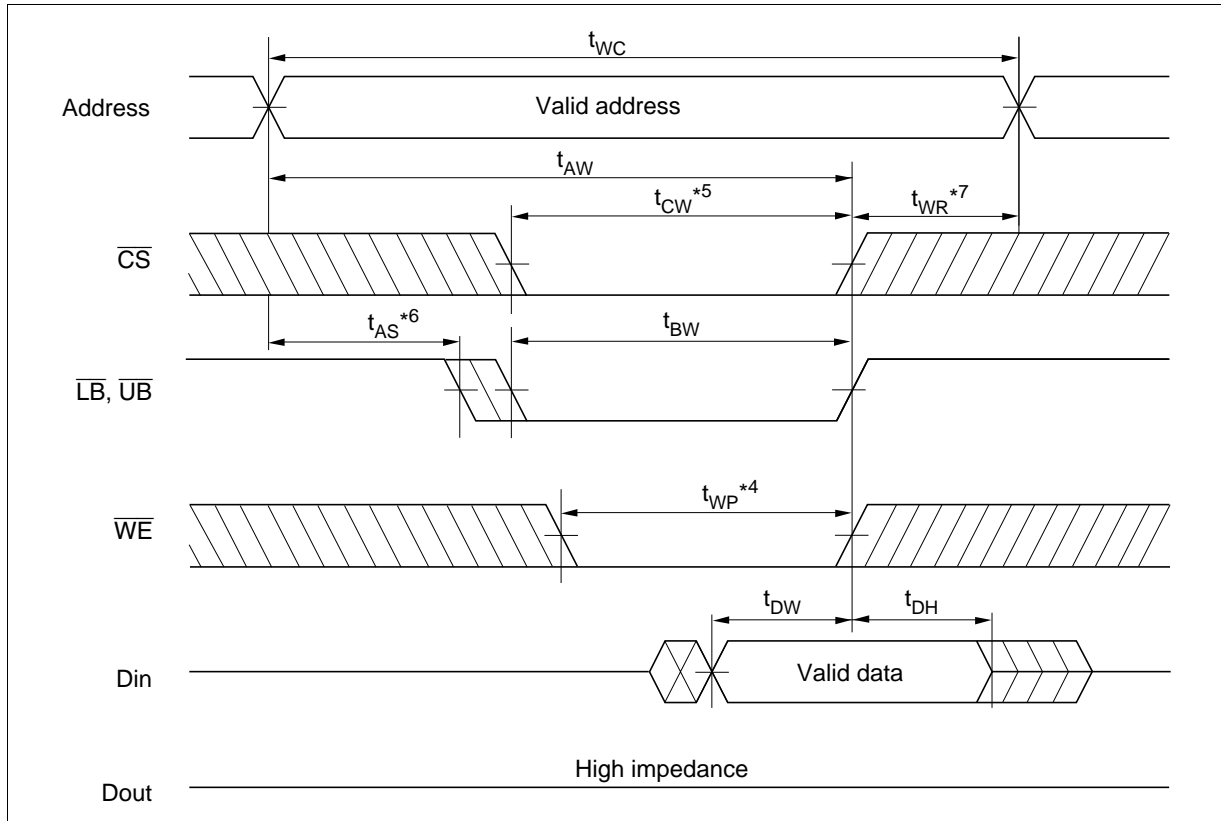

**Low  $V_{CC}$  Data Retention Characteristics ( $T_a = 0$  to  $+70^\circ\text{C}$ )**

Parameter	Symbol	Min	Typ <sup>*4</sup>	Max	Unit	Test conditions <sup>*3</sup>
$V_{CC}$ for data retention	$V_{DR}$	2.0	—	—	V	$V_{in} \geq 0V$ (1) $\overline{CS} \geq V_{CC} - 0.2V$ or (2) $\overline{LB} = \overline{UB} \geq V_{CC} - 0.2V$ $\overline{CS} \leq 0.2V$
Data retention current	$I_{CCDR}^{*1}$	—	0.8	20	$\mu\text{A}$	$V_{CC} = 3.0V, V_{in} \geq 0V$ (1) $\overline{CS} \geq V_{CC} - 0.2V$ or (2) $\overline{LB} = \overline{UB} \geq V_{CC} - 0.2V$ $\overline{CS} \leq 0.2V$
	$I_{CCDR}^{*2}$	—	0.8	10	$\mu\text{A}$	
Chip deselect to data retention time	$t_{CDR}$	0	—	—	ns	See retention waveform
Operation recovery time	$t_R$	$t_{RC}^{*5}$	—	—	ns	

- Notes:
1. This characteristic is guaranteed only for L-version, 10  $\mu\text{A}$  max. at  $T_a = 0$  to  $+40^\circ\text{C}$ .
  2. This characteristic is guaranteed only for L-SL version, 5  $\mu\text{A}$  max. at  $T_a = 0$  to  $+40^\circ\text{C}$ .
  3.  $\overline{CS}$  controls address buffer,  $\overline{WE}$  buffer,  $\overline{OE}$  buffer,  $\overline{LB}$ ,  $\overline{UB}$  buffer and  $D_{in}$  buffer. If  $\overline{CS}$  controls data retention mode,  $V_{in}$  levels (address,  $\overline{WE}$ ,  $\overline{OE}$ ,  $\overline{LB}$ ,  $\overline{UB}$ , I/O) can be in the high impedance state. If  $\overline{LB}$ ,  $\overline{UB}$  controls data retention mode,  $\overline{LB}$ ,  $\overline{UB}$  must be  $\overline{LB} = \overline{UB} \geq V_{CC} - 0.2V$ ,  $\overline{CS}$  must be  $\overline{CS} \leq 0.2V$ . The other input levels (address,  $\overline{WE}$ ,  $\overline{OE}$ , I/O) can be in the high impedance state.
  4. Typical values are at  $V_{CC} = 3.0V$ ,  $T_a = +25^\circ\text{C}$  and not guaranteed.
  5.  $t_{RC}$  = read cycle time.

---

## HM62W16258B Series

---

Low  $V_{CC}$  Data Retention Timing Waveform (1) ( $\overline{CS}$  Controlled)

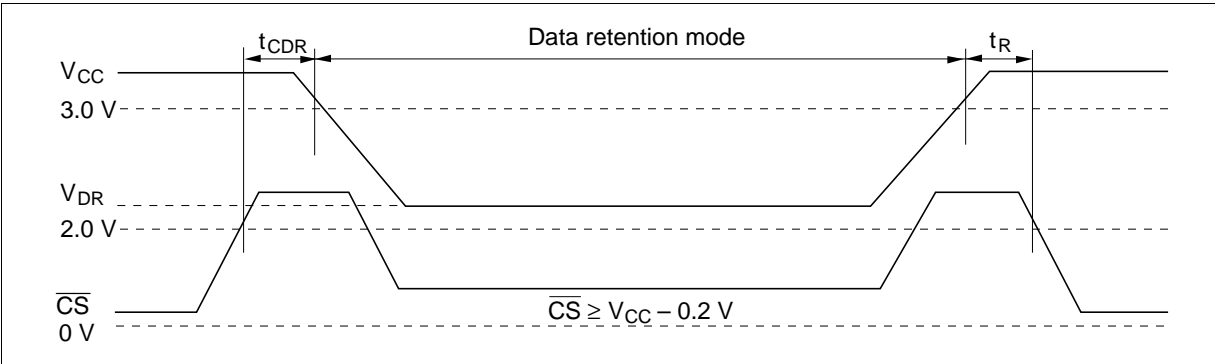

Low  $V_{CC}$  Data Retention Timing Waveform (2) ( $\overline{LB}$ ,  $\overline{UB}$  Controlled)

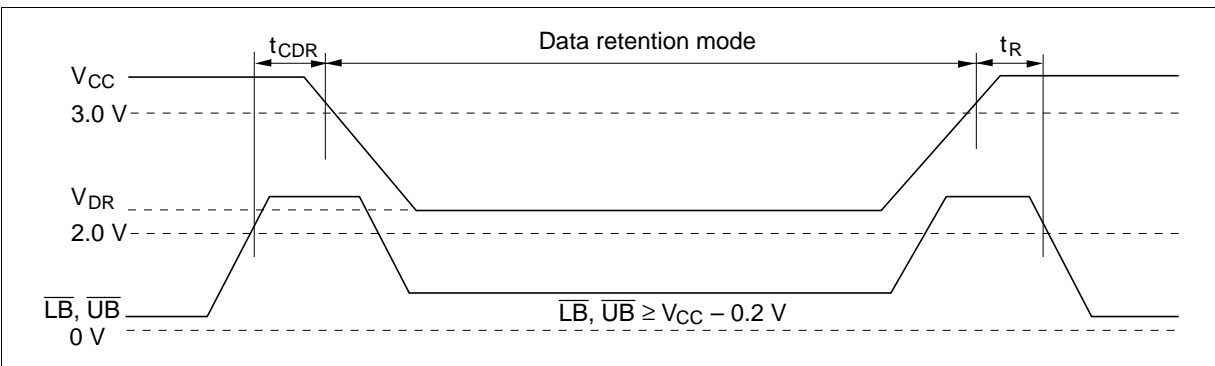

# HM62W16258B Series

## Package Dimensions

### HM62W16258BLTT Series (TTP-44DB)

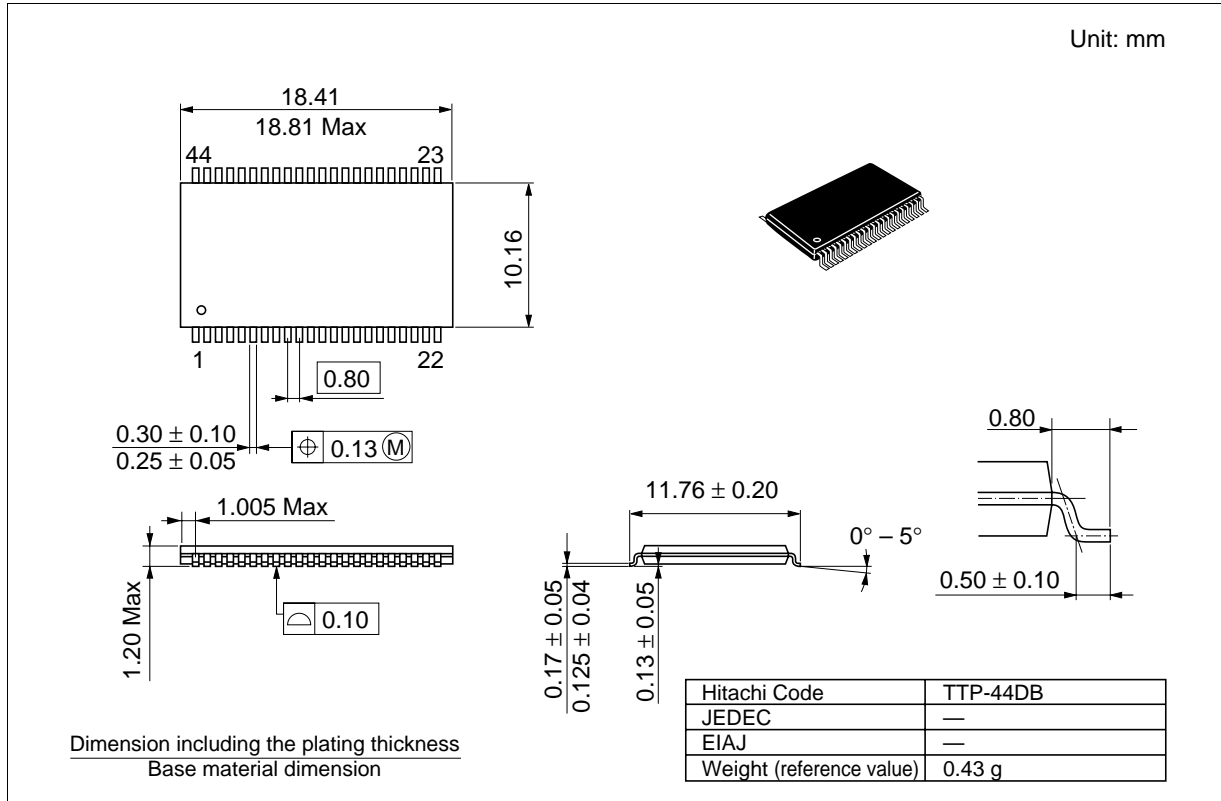

---

## HM62W16258B Series

---

### Cautions

1. Hitachi neither warrants nor grants licenses of any rights of Hitachi's or any third party's patent, copyright, trademark, or other intellectual property rights for information contained in this document. Hitachi bears no responsibility for problems that may arise with third party's rights, including intellectual property rights, in connection with use of the information contained in this document.
2. Products and product specifications may be subject to change without notice. Confirm that you have received the latest product standards or specifications before final design, purchase or use.
3. Hitachi makes every attempt to ensure that its products are of high quality and reliability. However, contact Hitachi's sales office before using the product in an application that demands especially high quality and reliability or where its failure or malfunction may directly threaten human life or cause risk of bodily injury, such as aerospace, aeronautics, nuclear power, combustion control, transportation, traffic, safety equipment or medical equipment for life support.
4. Design your application so that the product is used within the ranges guaranteed by Hitachi particularly for maximum rating, operating supply voltage range, heat radiation characteristics, installation conditions and other characteristics. Hitachi bears no responsibility for failure or damage when used beyond the guaranteed ranges. Even within the guaranteed ranges, consider normally foreseeable failure rates or failure modes in semiconductor devices and employ systemic measures such as fail-safes, so that the equipment incorporating Hitachi product does not cause bodily injury, fire or other consequential damage due to operation of the Hitachi product.
5. This product is not designed to be radiation resistant.
6. No one is permitted to reproduce or duplicate, in any form, the whole or part of this document without written approval from Hitachi.
7. Contact Hitachi's sales office for any questions regarding this document or Hitachi semiconductor products.

---

---

# HITACHI

## Hitachi, Ltd.

Semiconductor & Integrated Circuits.  
Nippon Bldg., 2-6-2, Ohte-machi, Chiyoda-ku, Tokyo 100-0004, Japan  
Tel: Tokyo (03) 3270-2111 Fax: (03) 3270-5109

URL   NorthAmerica   : <http://semiconductor.hitachi.com/>  
      Europe         : <http://www.hitachi-eu.com/hel/ecg>  
      Asia (Singapore) : <http://www.has.hitachi.com.sg/grp3/sicd/index.htm>  
      Asia (Taiwan)    : [http://www.hitachi.com.tw/E/Product/SICD\\_Frame.htm](http://www.hitachi.com.tw/E/Product/SICD_Frame.htm)  
      Asia (HongKong) : <http://www.hitachi.com.hk/eng/bo/grp3/index.htm>  
      Japan           : <http://www.hitachi.co.jp/Sicd/indx.htm>

### For further information write to:

Hitachi Semiconductor  
(America) Inc.  
179 East Tasman Drive,  
San Jose, CA 95134  
Tel: <1> (408) 433-1990  
Fax: <1> (408) 433-0223

Hitachi Europe GmbH  
Electronic components Group  
Domacher StraÙe 3  
D-85622 Feldkirchen, Munich  
Germany  
Tel: <49> (89) 9 9180-0  
Fax: <49> (89) 9 29 30 00  
  
Hitachi Europe Ltd.  
Electronic Components Group.  
Whitebrook Park  
Lower Cookham Road  
Maidenhead  
Berkshire SL6 8YA, United Kingdom  
Tel: <44> (1628) 585000  
Fax: <44> (1628) 778322

Hitachi Asia Pte. Ltd.  
16 Collyer Quay #20-00  
Hitachi Tower  
Singapore 049318  
Tel: 535-2100  
Fax: 535-1533

Hitachi Asia Ltd.  
Taipei Branch Office  
3F, Hung Kuo Building, No.167,  
Tun-Hwa North Road, Taipei (105)  
Tel: <886> (2) 2718-3666  
Fax: <886> (2) 2718-8180

Hitachi Asia (Hong Kong) Ltd.  
Group III (Electronic Components)  
7/F., North Tower, World Finance Centre,  
Harbour City, Canton Road, Tsim Sha Tsui,  
Kowloon, Hong Kong  
Tel: <852> (2) 735 9218  
Fax: <852> (2) 730 0281  
Telex: 40815 HITEC HX

Copyright © Hitachi, Ltd., 1998. All rights reserved. Printed in Japan.

HITACHI