

# SIEMENS

## 5 mm (T1 3/4) MULTILED®, Diffused

LU 5351

### Besondere Merkmale

- nicht eingefärbtes, teilweise diffuses Gehäuse
- Lötspieße im 2.54 mm Raster
- hohe Signalwirkung durch Farbwechsel der LED möglich
- Anzeige unterschiedlicher Betriebszustände durch Farbwechsel grün über gelb und orange bis rot möglich
- beide Farben getrennt ansteuerbar
- Lötspieße mit Aufsetzebene
- gegurtet lieferbar
- Störimpulsfest nach DIN 40839

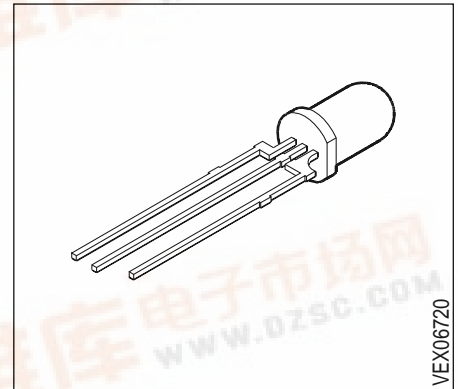

### Features

- colorless, partly diffused package
- 2.54 mm lead spacing
- high signal efficiency possible by color change of the LED
- indication of different operation modes is possible by color change from green to yellow, orange and super-red
- both colors can be controlled separately
- solder leads with stand-off
- available taped on reel
- load dump resistant acc. to DIN 40839

Typ Type	Emissionsfarbe Color of Emission	Gehäusefarbe Color of Package	Lichtstärke Luminous Intensity $I_F = 10 \text{ mA}$ $I_V \text{ (mcd)}$	Bestellnummer Ordering Code
LU 5351-GL	super-red / green	colorless clear, diffused	1.6 ... 20	Q62703-Q2046
LU 5351-JM	super-red / green		4.0 ... 32	Q62703-Q2047

Streuung der Lichtstärke in einer Verpackungseinheit  $I_{V \max} / I_{V \min} \leq 2.0$ .<sup>1)</sup>

Streuung der Lichtstärke in einer LED  $I_{V \max} / I_{V \min} \leq 4.0$  (LU 5351-GL),  $\leq 2.0$  (LU 5351-JM).

<sup>1)</sup> Bei MULTILED® bestimmt die Helligkeit des jeweils dunkleren Chips in einem Gehäuse die Helligkeitsgruppe der LED.

Luminous intensity ratio in one packaging unit  $I_{V \max} / I_{V \min} \leq 2.0$ .<sup>1)</sup>

Luminous intensity ratio in one LED  $I_{V \max} / I_{V \min} \leq 4.0$  (LU 5351-GL),  $\leq 2.0$  (LU 5351-JM).

<sup>1)</sup> In case of MULTILED®, the brightness of the darker chip in one package unit determines the brightness group of the LED.

## Grenzwerte Maximum Ratings

Bezeichnung Parameter	Symbol Symbol	Werte Values	Einheit Unit
Betriebstemperatur Operating temperature range	$T_{op}$	- 55 ... + 100	°C
Lagertemperatur Storage temperature range	$T_{stg}$	- 55 ... + 100	°C
Sperrschichttemperatur Junction temperature	$T_j$	+ 100	°C
Durchlaßstrom Forward current	$I_F$	40 <sup>1)</sup>	mA
Stoßstrom Surge current $t \leq 10 \mu s, D = 0.005$	$I_{FM}$	0.5 <sup>1)</sup>	A
Verlustleistung Power dissipation $T_A \leq 25 \text{ °C}$	$P_{tot}$	140 <sup>1)</sup>	mW
Wärmewiderstand Thermal resistance Sperrschicht / Luft Junction / air	$R_{th JA}$	400	K/W

<sup>1)</sup> Bei gleichzeitigem Betrieb beider Dioden darf die Summe aus Strom und Verlustleistung nicht die angegebenen Grenzen überschreiten.

<sup>1)</sup> With simultaneous operation of both diodes the sum of the current and the power dissipation may not exceed the specified limits.

## Kennwerte ( $T_A = 25\text{ °C}$ )

### Characteristics

Bezeichnung Parameter	Symbol Symbol	Werte Values		Einheit Unit
		super-red	green	
Wellenlänge des emittierten Lichtes Wavelength at peak emission $I_F = 20\text{ mA}$	(typ.) $\lambda_{\text{peak}}$	635	565	nm
Dominantwellenlänge Dominant wavelength $I_F = 20\text{ mA}$	(typ.) $\lambda_{\text{dom}}$	628	570	nm
Spektrale Bandbreite bei 50 % $I_{\text{rel max}}$ Spectral bandwidth at 50 % $I_{\text{rel max}}$ $I_F = 20\text{ mA}$	(typ.) $\Delta\lambda$	45	25	nm
Abstrahlwinkel bei 50 % $I_V$ (Vollwinkel) Viewing angle at 50 % $I_V$	$2\phi$	50	50	Grad deg.
Durchlaßspannung Forward voltage $I_F = 10\text{ mA}$	(typ.) $V_F$ (max.) $V_F$	2.0 2.6	2.0 2.6	V V
Kapazität Capacitance $V_R = 0\text{ V}, f = 1\text{ MHz}$	(typ.) $C_0$	12	15	pF
Schaltzeiten: Switching times: $I_V$ from 10 % to 90 % $I_V$ from 90 % to 10 % $I_F = 100\text{ mA}, t_p = 10\text{ }\mu\text{s}, R_L = 50\text{ }\Omega$	(typ.) $t_r$ (typ.) $t_f$	300 150	450 200	ns ns

**Relative spektrale Emission**  $I_{rel} = f(\lambda)$ ,  $T_A = 25\text{ °C}$ ,  $I_F = 20\text{ mA}$

**Relative spectral emission**

$V(\lambda)$  = spektrale Augenempfindlichkeit  
Standard eye response curve

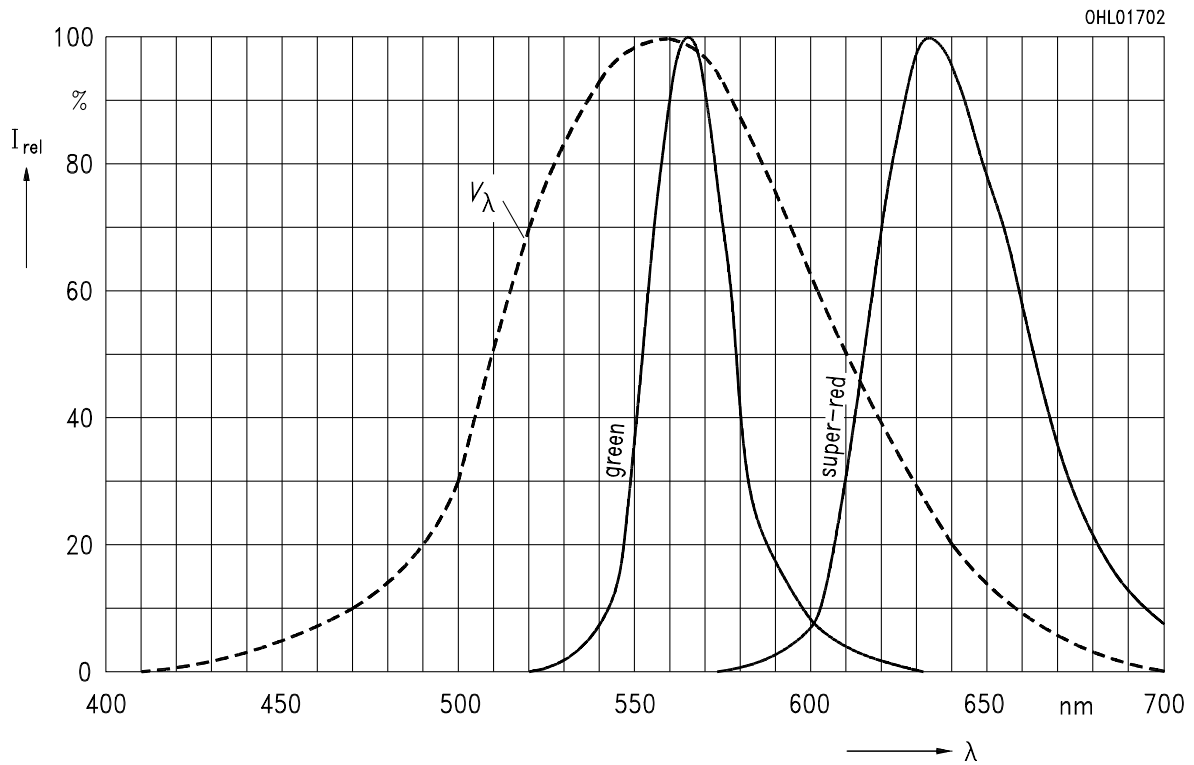

**Abstrahlcharakteristik**  $I_{rel} = f(\varphi)$

**Radiation characteristic**

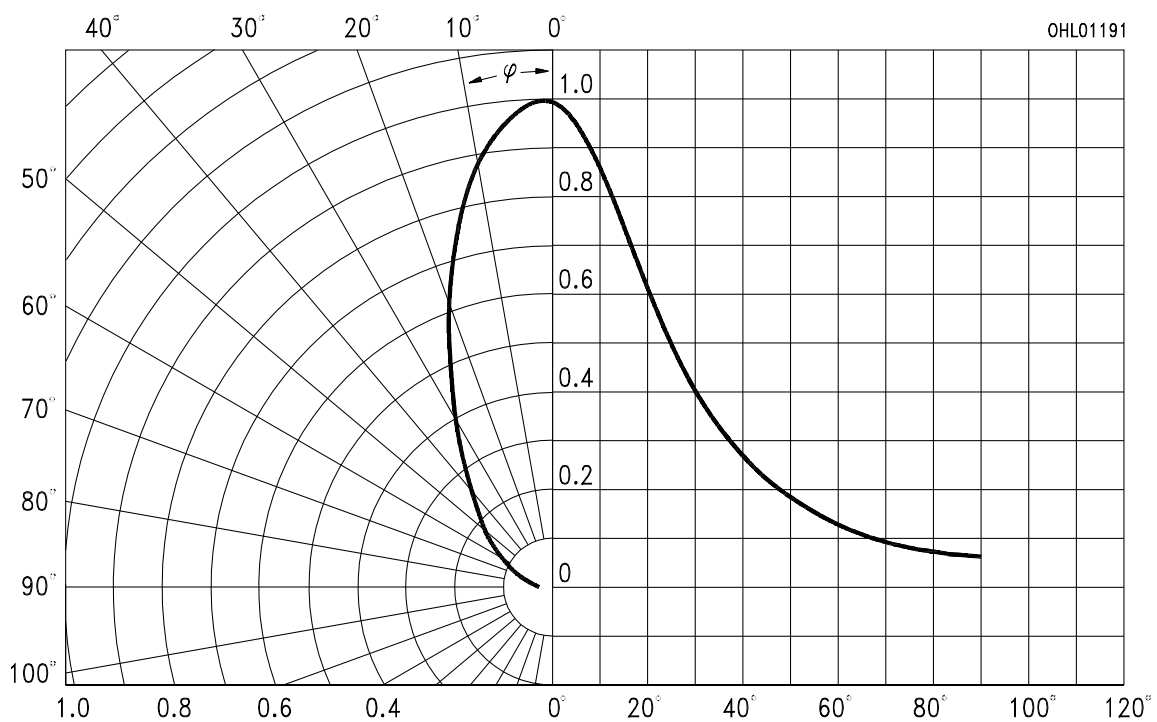

**Durchlaßstrom  $I_F = f(V_F)$**

**Forward current**

$T_A = 25\text{ °C}$

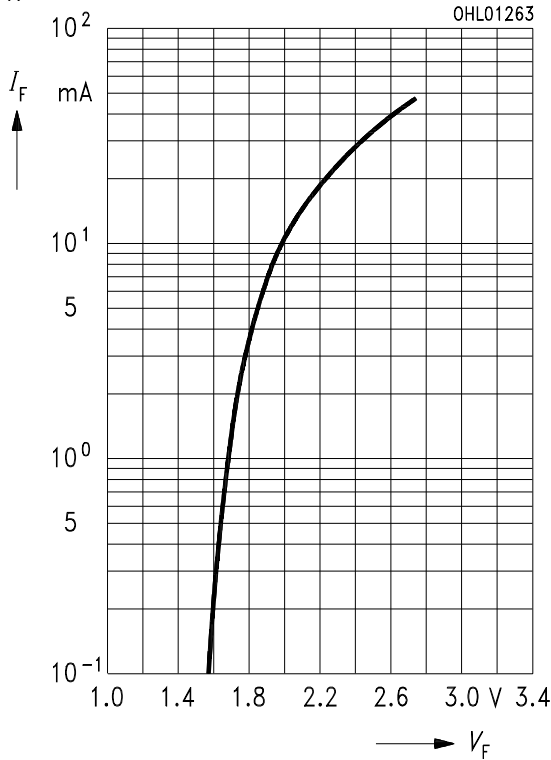

**Relative Lichtstärke  $I_V/I_{V(10\text{mA})} = f(I_F)$**

**Relative luminous intensity**

$T_A = 25\text{ °C}$

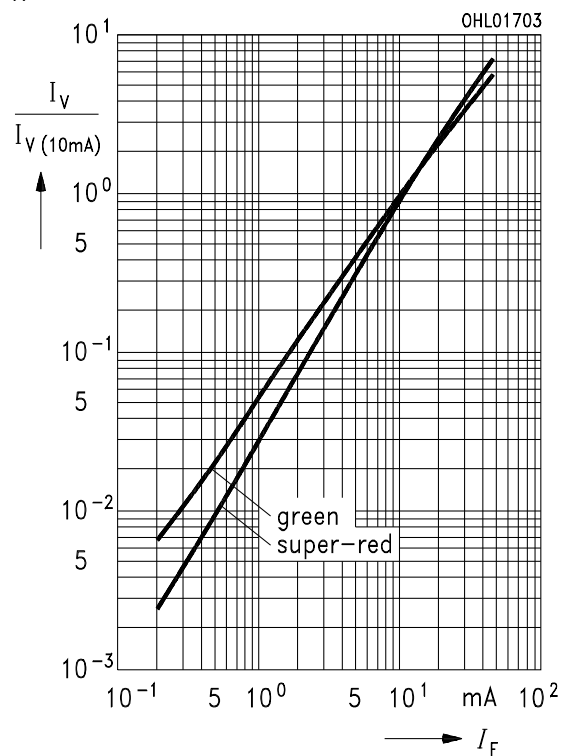

**Zulässige Impulsbelastbarkeit  $I_F = f(t_P)$**

**Permissible pulse handling capability**

Duty cycle  $D = \text{parameter}$ ,  $T_A = 25\text{ °C}$

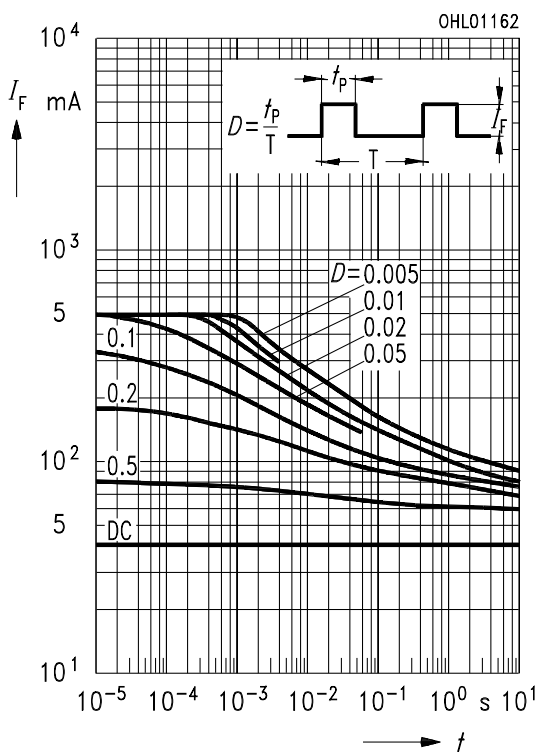

**Maximal zulässiger Durchlaßstrom**

**Max. permissible forward current**

$I_F = f(T_A)$

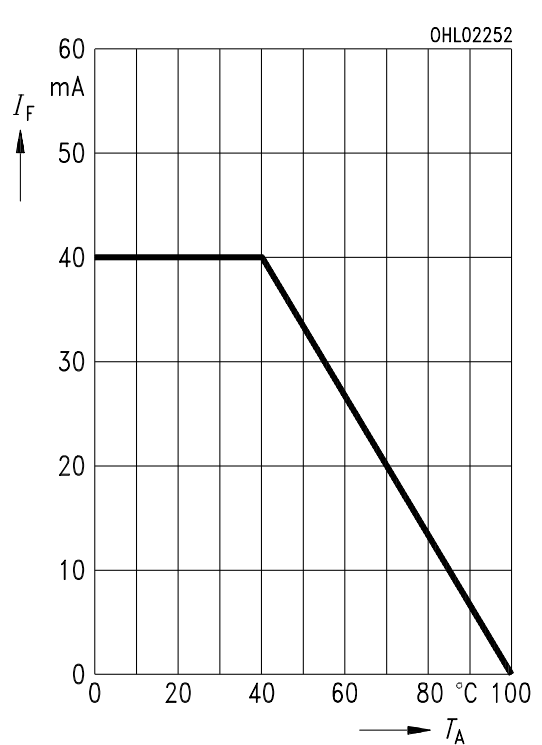

**Wellenlänge der Strahlung  $\lambda_{\text{peak}} = f(T_A)$**   
**Wavelength at peak emission**

$I_F = 20 \text{ mA}$

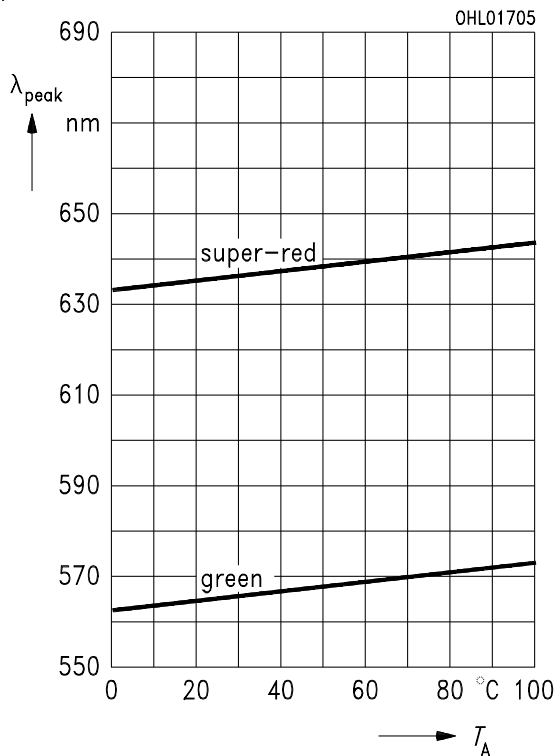

**Dominantwellenlänge  $\lambda_{\text{dom}} = f(T_A)$**   
**Dominant wavelength**

$I_F = 20 \text{ mA}$

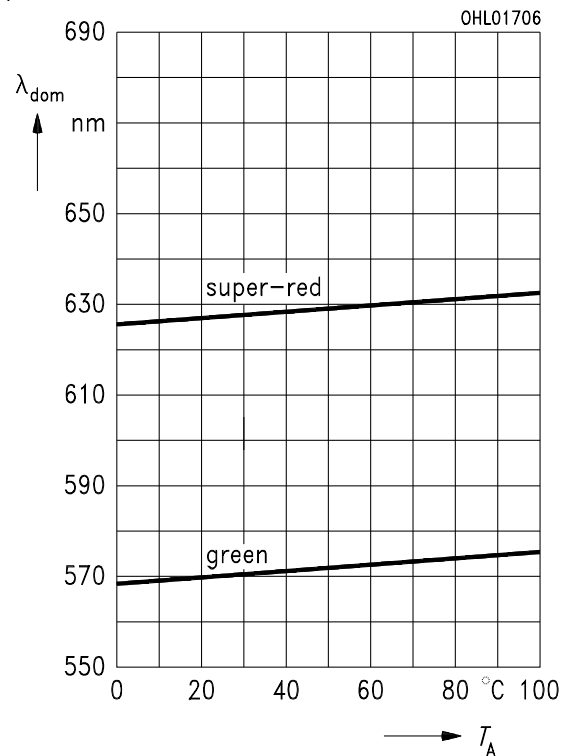

**Durchlaßspannung  $V_F = f(T_A)$**   
**Forward voltage**

$I_F = 10 \text{ mA}$

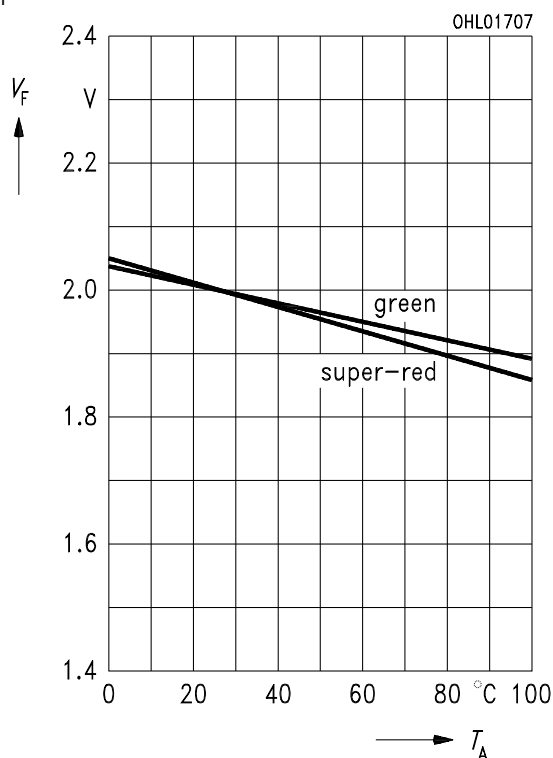

**Relative Lichtstärke  $I_V/I_{V(25^\circ\text{C})} = f(T_A)$**   
**Relative luminous intensity**

$I_F = 10 \text{ mA}$

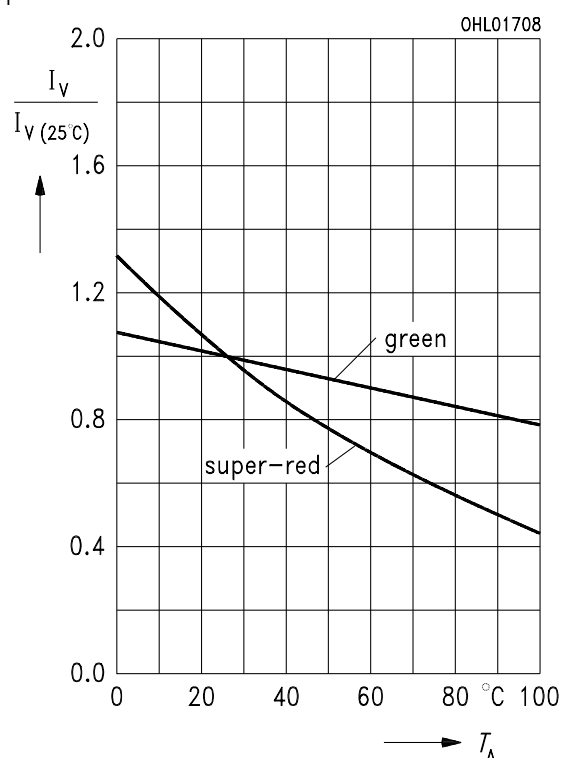

**Maßzeichnung** (Maße in mm, wenn nicht anders angegeben)  
**Package Outlines** (Dimensions in mm, unless otherwise specified)

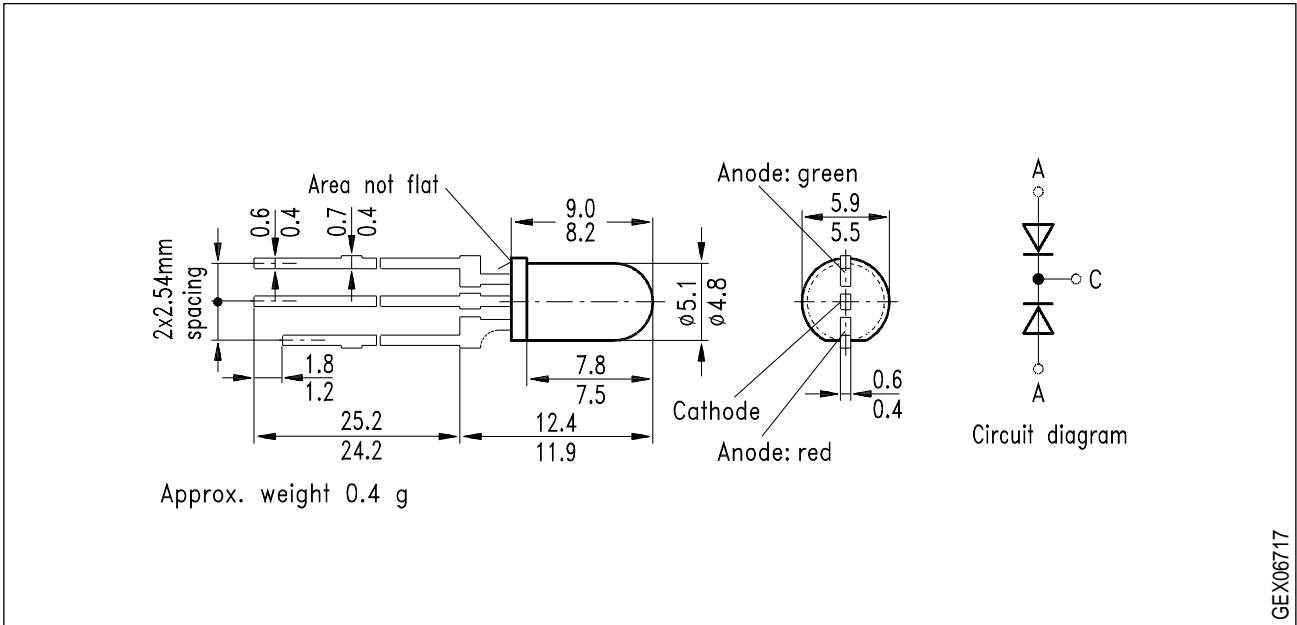

**Kathodenkennzeichnung:** Mittlerer Lötspieß  
**Cathode mark:** Middle solder lead