

Common Cathode Silicon Dual Switching Diode

This Common Cathode Silicon Epitaxial Planar Dual Diode is designed for use in ultra high speed switching applications. This device is housed in the SC-70 package which is designed for low power surface mount applications.

- Fast t_{rr} , < 3.0 ns
- Low C_D , < 2.0 pF
- Available in 8 mm Tape and Reel
Use M1MA141/2WKT1 to order the 7 inch/3000 unit reel.
Use M1MA141/2WKT3 to order the 13 inch/10,000 unit reel.

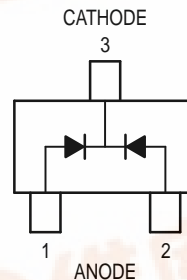

M1MA141WKT1
M1MA142WKT1

Motorola Preferred Devices

SC-70/SOT-323 PACKAGE
COMMON CATHODE
DUAL SWITCHING DIODE
40/80 V-100 mA
SURFACE MOUNT

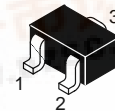

CASE 419-02, STYLE 5
SC-70/SOT-323

MAXIMUM RATINGS ($T_A = 25^\circ\text{C}$)

Rating		Symbol	Value	Unit
Reverse Voltage	M1MA141WKT1	V_R	40	Vdc
	M1MA142WKT1		80	
Peak Reverse Voltage	M1MA141WKT1	V_{RM}	40	Vdc
	M1MA142WKT1		80	
Forward Current	Single	I_F	100	mAdc
	Dual		150	
Peak Forward Current	Single	I_{FM}	225	mAdc
	Dual		340	
Peak Forward Surge Current	Single	$I_{FSM}^{(1)}$	500	mAdc
	Dual		750	

THERMAL CHARACTERISTICS

Rating	Symbol	Max	Unit
Power Dissipation	P_D	150	mW
Junction Temperature	T_J	150	$^\circ\text{C}$
Storage Temperature	T_{stg}	-55 ~ +150	$^\circ\text{C}$

ELECTRICAL CHARACTERISTICS ($T_A = 25^\circ\text{C}$)

Characteristic		Symbol	Condition	Min	Max	Unit
Reverse Voltage Leakage Current	M1MA141WKT1	I_R	$V_R = 35\text{ V}$	—	0.1	μAdc
	M1MA142WKT1		$V_R = 75\text{ V}$	—	0.1	
Forward Voltage		V_F	$I_F = 100\text{ mA}$	—	1.2	Vdc
Reverse Breakdown Voltage	M1MA141WKT1	V_R	$I_R = 100\ \mu\text{A}$	40	—	Vdc
	M1MA142WKT1			80	—	
Diode Capacitance		C_D	$V_R = 0, f = 1.0\text{ MHz}$	—	2.0	pF
Reverse Recovery Time		$t_{rr}^{(2)}$	$I_F = 10\text{ mA}, V_R = 6.0\text{ V}, R_L = 100\ \Omega, I_{rr} = 0.1 I_R$	—	3.0	ns

1. $t = 1\text{ SEC}$

2. t_{rr} Test Circuit

Thermal Clad is a trademark of the Bergquist Company

Preferred devices are Motorola recommended choices for future use and best overall value.

REV. 2



MOTOROLA

M1MA141WKT1 M1MA142WKT1

RECOVERY TIME EQUIVALENT TEST CIRCUIT

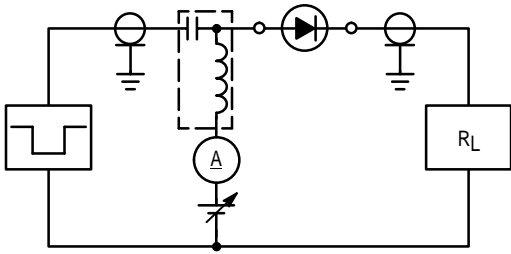

INPUT PULSE

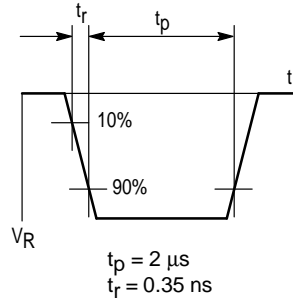

OUTPUT PULSE

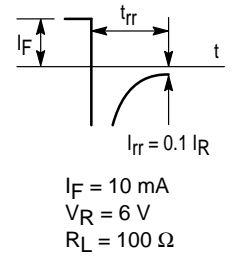

DEVICE MARKING — EXAMPLE

Marking Symbol		
Type No.	141WK	142WK
Symbol	MT	MU

The "X" represents a smaller alpha digit Date Code. The Date Code indicates the actual month in which the part was manufactured.

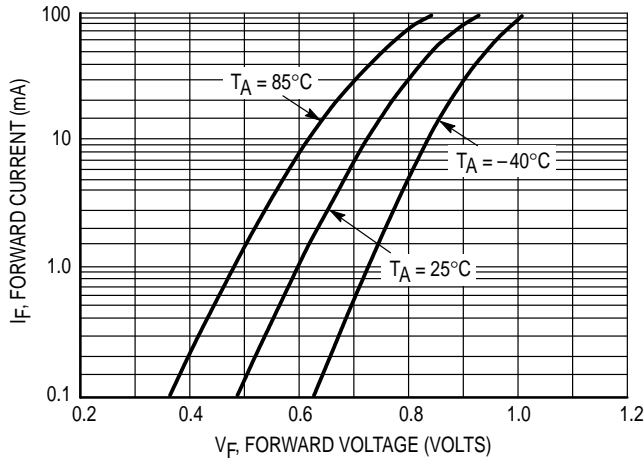

Figure 1. Forward Voltage

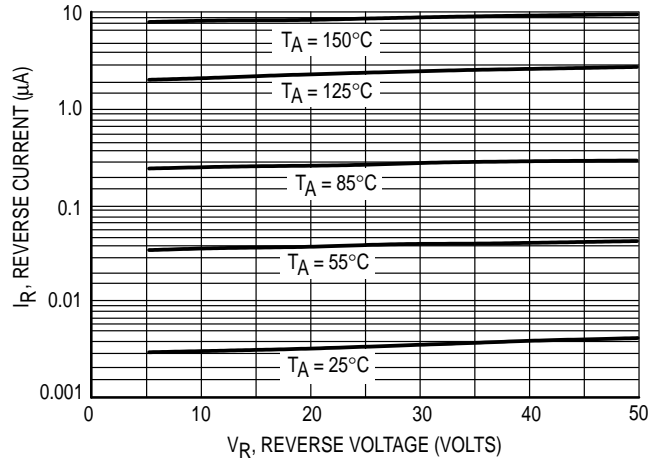

Figure 2. Reverse Current

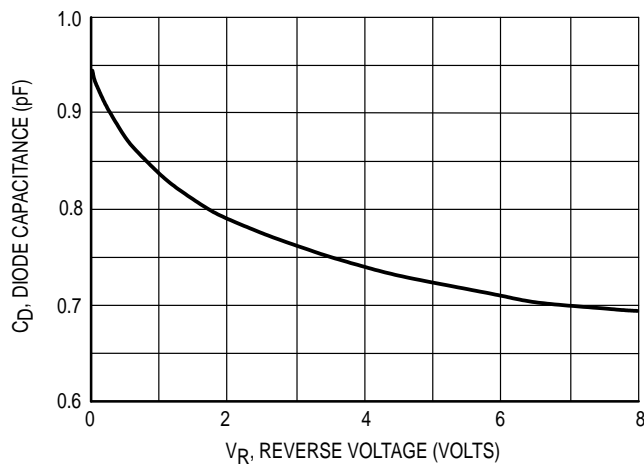
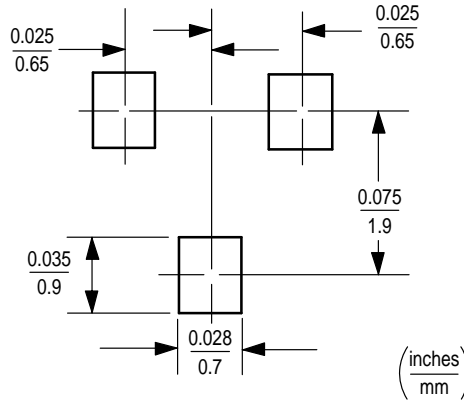

Figure 3. Diode Capacitance

MINIMUM RECOMMENDED FOOTPRINT FOR SURFACE MOUNTED APPLICATIONS

Surface mount board layout is a critical portion of the total design. The footprint for the semiconductor packages must be the correct size to insure proper solder connection

interface between the board and the package. With the correct pad geometry, the packages will self align when subjected to a solder reflow process.



SC-70/SOT-323 POWER DISSIPATION

The power dissipation of the SC-70/SOT-323 is a function of the collector pad size. This can vary from the minimum pad size for soldering to the pad size given for maximum power dissipation. Power dissipation for a surface mount device is determined by $T_{J(max)}$, the maximum rated junction temperature of the die, $R_{\theta JA}$, the thermal resistance from the device junction to ambient; and the operating temperature, T_A . Using the values provided on the data sheet, P_D can be calculated as follows.

$$P_D = \frac{T_{J(max)} - T_A}{R_{\theta JA}}$$

The values for the equation are found in the maximum ratings table on the data sheet. Substituting these values into

the equation for an ambient temperature T_A of 25°C, one can calculate the power dissipation of the device which in this case is 150 milliwatts.

$$P_D = \frac{150^\circ\text{C} - 25^\circ\text{C}}{833^\circ\text{C/W}} = 150 \text{ milliwatts}$$

The 833°C/W assumes the use of the recommended footprint on a glass epoxy printed circuit board to achieve a power dissipation of 150 milliwatts. Another alternative would be to use a ceramic substrate or an aluminum core board such as Thermal Clad™. Using a board material such as Thermal Clad, a power dissipation of 300 milliwatts can be achieved using the same footprint.

SOLDERING PRECAUTIONS

The melting temperature of solder is higher than the rated temperature of the device. When the entire device is heated to a high temperature, failure to complete soldering within a short time could result in device failure. Therefore, the following items should always be observed in order to minimize the thermal stress to which the devices are subjected.

- Always preheat the device.
- The delta temperature between the preheat and soldering should be 100°C or less.*
- When preheating and soldering, the temperature of the leads and the case must not exceed the maximum temperature ratings as shown on the data sheet. When using infrared heating with the reflow soldering method, the difference should be a maximum of 10°C.

- The soldering temperature and time should not exceed 260°C for more than 10 seconds.
- When shifting from preheating to soldering, the maximum temperature gradient should be 5°C or less.
- After soldering has been completed, the device should be allowed to cool naturally for at least three minutes. Gradual cooling should be used as the use of forced cooling will increase the temperature gradient and result in latent failure due to mechanical stress.
- Mechanical stress or shock should not be applied during cooling

* Soldering a device without preheating can cause excessive thermal shock and stress which can result in damage to the device.

M1MA141WKT1 M1MA142WKT1

SOLDER STENCIL GUIDELINES

Prior to placing surface mount components onto a printed circuit board, solder paste must be applied to the pads. A solder stencil is required to screen the optimum amount of solder paste onto the footprint. The stencil is made of brass

or stainless steel with a typical thickness of 0.008 inches. The stencil opening size for the surface mounted package should be the same as the pad size on the printed circuit board, i.e., a 1:1 registration.

TYPICAL SOLDER HEATING PROFILE

For any given circuit board, there will be a group of control settings that will give the desired heat pattern. The operator must set temperatures for several heating zones, and a figure for belt speed. Taken together, these control settings make up a heating "profile" for that particular circuit board. On machines controlled by a computer, the computer remembers these profiles from one operating session to the next. Figure 4 shows a typical heating profile for use when soldering a surface mount device to a printed circuit board. This profile will vary among soldering systems but it is a good starting point. Factors that can affect the profile include the type of soldering system in use, density and types of components on the board, type of solder used, and the type of board or substrate material being used. This profile shows temperature versus time. The line on the graph shows the

actual temperature that might be experienced on the surface of a test board at or near a central solder joint. The two profiles are based on a high density and a low density board. The Vitronics SMD310 convection/infrared reflow soldering system was used to generate this profile. The type of solder used was 62/36/2 Tin Lead Silver with a melting point between 177–189°C. When this type of furnace is used for solder reflow work, the circuit boards and solder joints tend to heat first. The components on the board are then heated by conduction. The circuit board, because it has a large surface area, absorbs the thermal energy more efficiently, then distributes this energy to the components. Because of this effect, the main body of a component may be up to 30 degrees cooler than the adjacent solder joints.

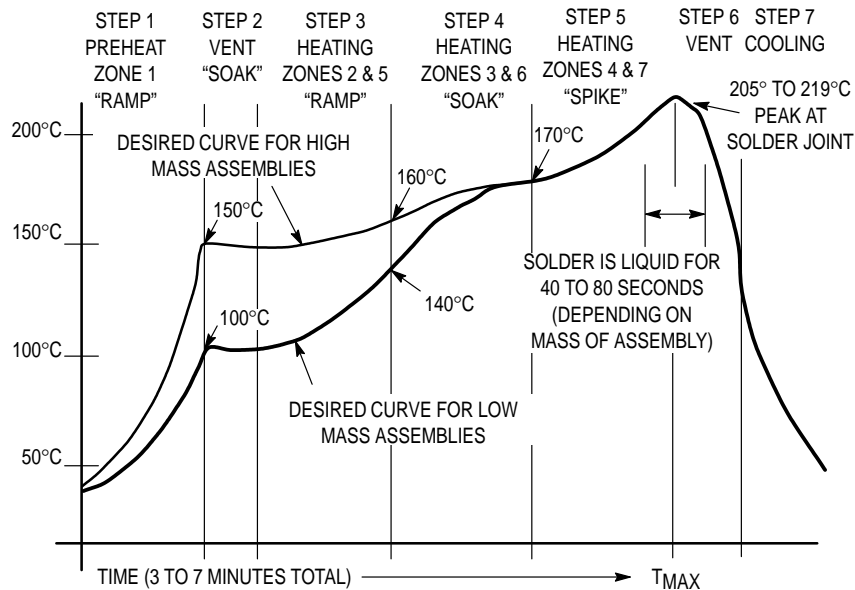
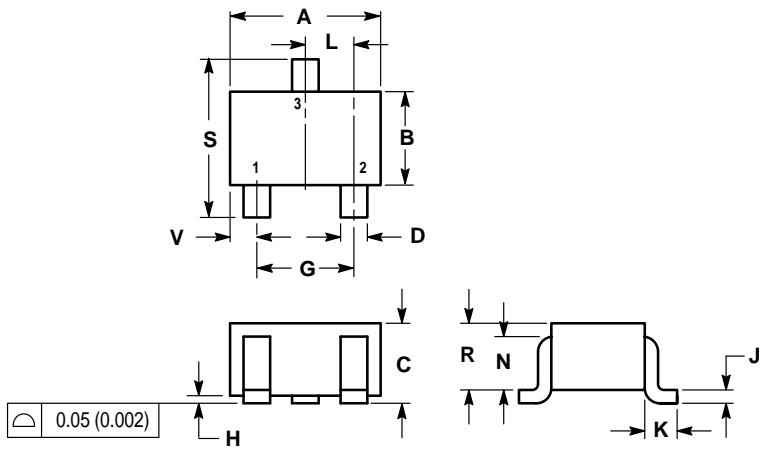

Figure 4. Typical Solder Heating Profile

M1MA141WKT1 M1MA142WKT1

PACKAGE DIMENSIONS



- NOTES:
 1. DIMENSIONING AND TOLERANCING PER ANSI Y14.5M, 1982.
 2. CONTROLLING DIMENSION: INCH.

DIM	INCHES		MILLIMETERS	
	MIN	MAX	MIN	MAX
A	0.071	0.087	1.80	2.20
B	0.045	0.053	1.15	1.35
C	0.035	0.049	0.90	1.25
D	0.012	0.016	0.30	0.40
G	0.047	0.055	1.20	1.40
H	0.000	0.004	0.00	0.10
J	0.004	0.010	0.10	0.25
K	0.017 REF		0.425 REF	
L	0.026 BSC		0.650 BSC	
N	0.028 REF		0.700 REF	
R	0.031	0.039	0.80	1.00
S	0.079	0.087	2.00	2.20
V	0.012	0.016	0.30	0.40

**CASE 419-02
 ISSUE H
 SC-70/SOT-323**

STYLE 5:
 PIN 1. ANODE
 2. ANODE
 3. CATHODE

M1MA141WKT1 M1MA142WKT1

Motorola reserves the right to make changes without further notice to any products herein. Motorola makes no warranty, representation or guarantee regarding the suitability of its products for any particular purpose, nor does Motorola assume any liability arising out of the application or use of any product or circuit, and specifically disclaims any and all liability, including without limitation consequential or incidental damages. "Typical" parameters which may be provided in Motorola data sheets and/or specifications can and do vary in different applications and actual performance may vary over time. All operating parameters, including "Typicals" must be validated for each customer application by customer's technical experts. Motorola does not convey any license under its patent rights nor the rights of others. Motorola products are not designed, intended, or authorized for use as components in systems intended for surgical implant into the body, or other applications intended to support or sustain life, or for any other application in which the failure of the Motorola product could create a situation where personal injury or death may occur. Should Buyer purchase or use Motorola products for any such unintended or unauthorized application, Buyer shall indemnify and hold Motorola and its officers, employees, subsidiaries, affiliates, and distributors harmless against all claims, costs, damages, and expenses, and reasonable attorney fees arising out of, directly or indirectly, any claim of personal injury or death associated with such unintended or unauthorized use, even if such claim alleges that Motorola was negligent regarding the design or manufacture of the part. Motorola and  are registered trademarks of Motorola, Inc. Motorola, Inc. is an Equal Opportunity/Affirmative Action Employer.

How to reach us:

USA/EUROPE/Locations Not Listed: Motorola Literature Distribution;
P.O. Box 20912; Phoenix, Arizona 85036. 1-800-441-2447 or 602-303-5454

MFAX: RMFAX0@email.sps.mot.com – TOUCHTONE 602-244-6609
INTERNET: <http://Design-NET.com>

JAPAN: Nippon Motorola Ltd.; Tatsumi-SPD-JLDC, 6F Seibu-Butsuryu-Center,
3-14-2 Tatsumi Koto-Ku, Tokyo 135, Japan. 03-81-3521-8315

ASIA/PACIFIC: Motorola Semiconductors H.K. Ltd.; 8B Tai Ping Industrial Park,
51 Ting Kok Road, Tai Po, N.T., Hong Kong. 852-26629298



MOTOROLA