

PAL/NTSC VIDEO CHROMA DEFLECTION

DESCRIPTION

The M52039SP is a semiconductor integrated circuit for video, chroma, and deflection signal processing. Combined with integrated component M51346AP for VIF/SIF, it realizes practical color television using only two IC components. Circuit configuration includes built-in sync separation, horizontal AFC, horizontal oscillator, horizontal count-down, vertical count-down, contrast control, luminance control, video tone control, ACC/killer detector, ident detector, APC detector, chroma oscillator, NTSC tint control, and chroma demodulator functions.

FEATURES

- PAL/NTSC/SECAM multi-system processing can be realized by adding IC component M52026SP for processing SECAM chroma signals.
- Large-scale, single-chip construction enhances practicality and reliability of the television set itself while contributing to lower power consumption.
- Places of adjustment and number of external components are minimized.
- NTSC system switch enables construction of a PAL/NTSC system with a minimal amount of peripheral components. (Switches demodulator axis, demodulation ratio, PAL matrix, and tint control.)
- Double AFC in the horizontal circuit effectively reduces weak electric field horizontal "jitter," and minimizes "bending" on the screen caused by luminance alteration. Coincidence detector circuit not only expands horizontal pull-in range, but can be used as a sensor signal for sound muting, automatic channel selection, etc.
- Contains built-in service switch. (Contrast minimum killer on, vertical output off)

PIN CONFIGURATION (TOP VIEW)

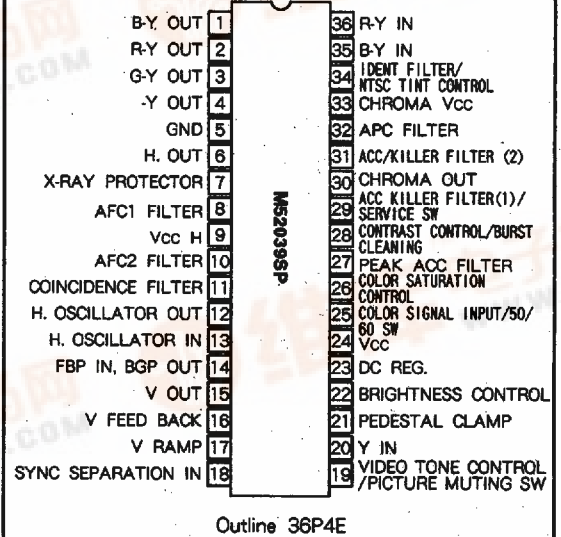

APPLICATION

PAL/SECAM Dual, PAL/SECAM System Color Television Receiver

RECOMMENDED OPERATING CONDITION

Supply voltage range.....10.0~12.5V
 Rated supply voltage.....12V



PAL/NTSC VIDEO CHROMA DEFLECTION

BLOCK DIAGRAM

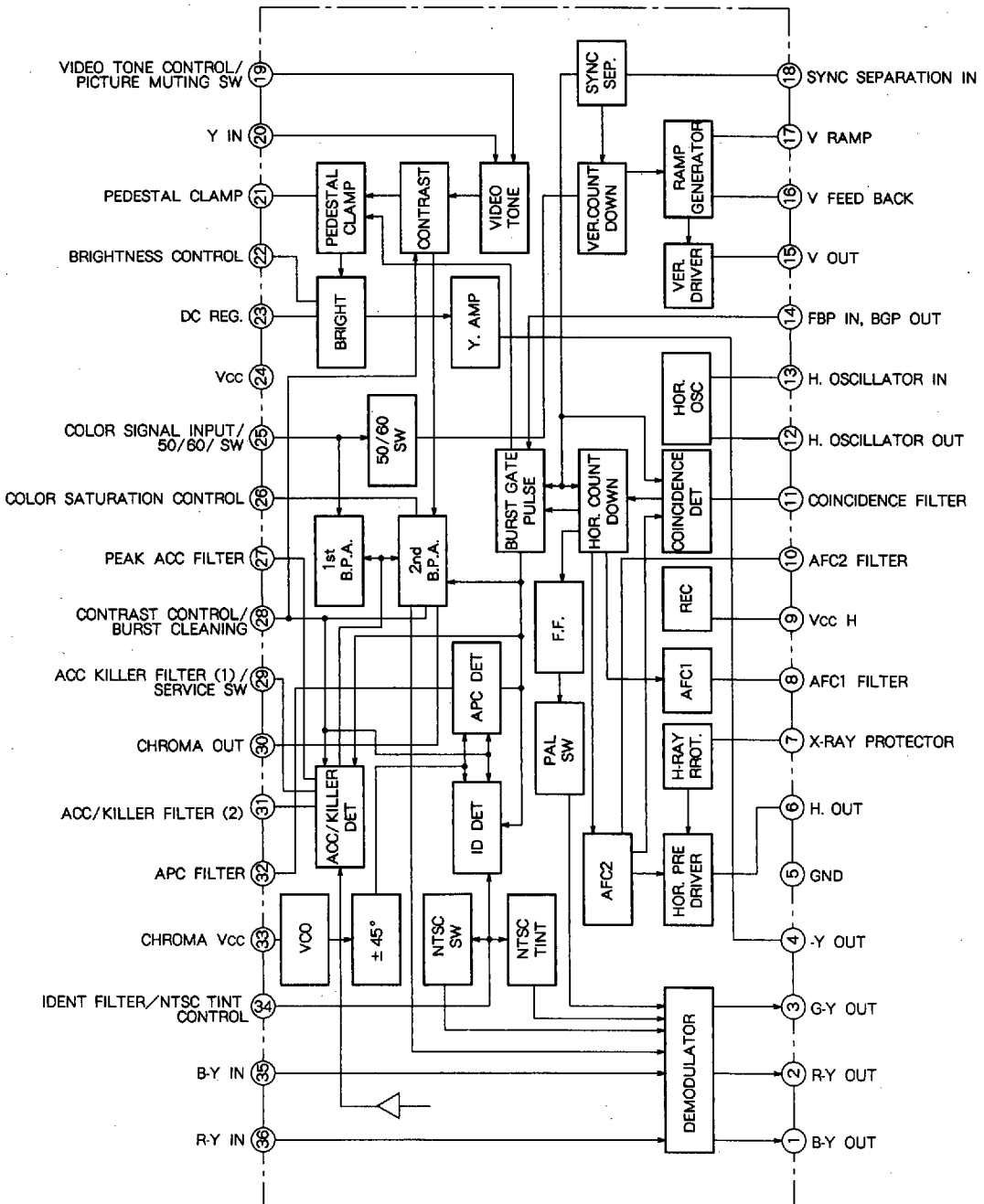

PAL/NTSC VIDEO CHROMA DEFLECTION

ABSOLUTE MAXIMUM RATINGS

Symbol	Parameter	Ratings	Unit
V _{cc}	Supply voltage	13.5	V
P _d	Power dissipation	1.25	W
T _{opr}	Operating temperature	-20~65	°C
T _{stg}	Storage temperature	-40~125	°C
Surge	Surge voltage resistance	200	V
Latch	Latch-up voltage resistance	300	V
V ₁₆	Pin ⑩ voltage	0.28V _{cc} + 6	V
I ₁₇	Pin ⑩ input current	+6	mA
I ₁₄	Pin ⑩ input current	-1.0	mA

ELECTRICAL CHARACTERISTICS (Cont.)

Symbol	Parameter	Test point	Input	Test conditions ("O" in the table below denotes switched "ON")																																			Limits			Unit																																																																																																																																																																																																																																																																																																																																																																																																																																																																																																																																																																																																																																																																																																																																																																																																																																																									
				V ₇	V _{9A}	V _{14A}	V _{17A}	V _{19A}	V ₂₁	V _{22A}	V ₂₄	V _{25A}	V _{26A}	V _{28A}	V _{34A}	V ₃₅	V ₃₆	V ₃₈	V ₆	V ₈	V ₁₆	V ₁₇	V ₁₈	V ₂₃	V ₂₅	V _{29A}	V ₃₁	V ₃₄	V ₃₅	V ₃₈	V ₃₉	V ₄₀	V ₄₁	V ₄₂	V ₄₃	V ₄₄	V ₄₅	V ₄₆	V ₄₇	V ₄₈	V ₄₉		V ₅₀	V ₅₁	V ₅₂	V ₅₃	V ₅₄	V ₅₅	V ₅₆	V ₅₇	V ₅₈	V ₅₉	V ₆₀	V ₆₁	V ₆₂	V ₆₃	V ₆₄	V ₆₅	V ₆₆	V ₆₇	V ₆₈	V ₆₉	V ₇₀	V ₇₁	V ₇₂	V ₇₃	V ₇₄	V ₇₅	V ₇₆	V ₇₇	V ₇₈	V ₇₉	V ₈₀	V ₈₁	V ₈₂	V ₈₃	V ₈₄	V ₈₅	V ₈₆	V ₈₇	V ₈₈	V ₈₉	V ₉₀	V ₉₁	V ₉₂	V ₉₃	V ₉₄	V ₉₅	V ₉₆	V ₉₇	V ₉₈	V ₉₉	V ₁₀₀	V ₁₀₁	V ₁₀₂	V ₁₀₃	V ₁₀₄	V ₁₀₅	V ₁₀₆	V ₁₀₇	V ₁₀₈	V ₁₀₉	V ₁₁₀	V ₁₁₁	V ₁₁₂	V ₁₁₃	V ₁₁₄	V ₁₁₅	V ₁₁₆	V ₁₁₇	V ₁₁₈	V ₁₁₉	V ₁₂₀	V ₁₂₁	V ₁₂₂	V ₁₂₃	V ₁₂₄	V ₁₂₅	V ₁₂₆	V ₁₂₇	V ₁₂₈	V ₁₂₉	V ₁₃₀	V ₁₃₁	V ₁₃₂	V ₁₃₃	V ₁₃₄	V ₁₃₅	V ₁₃₆	V ₁₃₇	V ₁₃₈	V ₁₃₉	V ₁₄₀	V ₁₄₁	V ₁₄₂	V ₁₄₃	V ₁₄₄	V ₁₄₅	V ₁₄₆	V ₁₄₇	V ₁₄₈	V ₁₄₉	V ₁₅₀	V ₁₅₁	V ₁₅₂	V ₁₅₃	V ₁₅₄	V ₁₅₅	V ₁₅₆	V ₁₅₇	V ₁₅₈	V ₁₅₉	V ₁₆₀	V ₁₆₁	V ₁₆₂	V ₁₆₃	V ₁₆₄	V ₁₆₅	V ₁₆₆	V ₁₆₇	V ₁₆₈	V ₁₆₉	V ₁₇₀	V ₁₇₁	V ₁₇₂	V ₁₇₃	V ₁₇₄	V ₁₇₅	V ₁₇₆	V ₁₇₇	V ₁₇₈	V ₁₇₉	V ₁₈₀	V ₁₈₁	V ₁₈₂	V ₁₈₃	V ₁₈₄	V ₁₈₅	V ₁₈₆	V ₁₈₇	V ₁₈₈	V ₁₈₉	V ₁₉₀	V ₁₉₁	V ₁₉₂	V ₁₉₃	V ₁₉₄	V ₁₉₅	V ₁₉₆	V ₁₉₇	V ₁₉₈	V ₁₉₉	V ₂₀₀	V ₂₀₁	V ₂₀₂	V ₂₀₃	V ₂₀₄	V ₂₀₅	V ₂₀₆	V ₂₀₇	V ₂₀₈	V ₂₀₉	V ₂₁₀	V ₂₁₁	V ₂₁₂	V ₂₁₃	V ₂₁₄	V ₂₁₅	V ₂₁₆	V ₂₁₇	V ₂₁₈	V ₂₁₉	V ₂₂₀	V ₂₂₁	V ₂₂₂	V ₂₂₃	V ₂₂₄	V ₂₂₅	V ₂₂₆	V ₂₂₇	V ₂₂₈	V ₂₂₉	V ₂₃₀	V ₂₃₁	V ₂₃₂	V ₂₃₃	V ₂₃₄	V ₂₃₅	V ₂₃₆	V ₂₃₇	V ₂₃₈	V ₂₃₉	V ₂₄₀	V ₂₄₁	V ₂₄₂	V ₂₄₃	V ₂₄₄	V ₂₄₅	V ₂₄₆	V ₂₄₇	V ₂₄₈	V ₂₄₉	V ₂₅₀	V ₂₅₁	V ₂₅₂	V ₂₅₃	V ₂₅₄	V ₂₅₅	V ₂₅₆	V ₂₅₇	V ₂₅₈	V ₂₅₉	V ₂₆₀	V ₂₆₁	V ₂₆₂	V ₂₆₃	V ₂₆₄	V ₂₆₅	V ₂₆₆	V ₂₆₇	V ₂₆₈	V ₂₆₉	V ₂₇₀	V ₂₇₁	V ₂₇₂	V ₂₇₃	V ₂₇₄	V ₂₇₅	V ₂₇₆	V ₂₇₇	V ₂₇₈	V ₂₇₉	V ₂₈₀	V ₂₈₁	V ₂₈₂	V ₂₈₃	V ₂₈₄	V ₂₈₅	V ₂₈₆	V ₂₈₇	V ₂₈₈	V ₂₈₉	V ₂₉₀	V ₂₉₁	V ₂₉₂	V ₂₉₃	V ₂₉₄	V ₂₉₅	V ₂₉₆	V ₂₉₇	V ₂₉₈	V ₂₉₉	V ₃₀₀	V ₃₀₁	V ₃₀₂	V ₃₀₃	V ₃₀₄	V ₃₀₅	V ₃₀₆	V ₃₀₇	V ₃₀₈	V ₃₀₉	V ₃₁₀	V ₃₁₁	V ₃₁₂	V ₃₁₃	V ₃₁₄	V ₃₁₅	V ₃₁₆	V ₃₁₇	V ₃₁₈	V ₃₁₉	V ₃₂₀	V ₃₂₁	V ₃₂₂	V ₃₂₃	V ₃₂₄	V ₃₂₅	V ₃₂₆	V ₃₂₇	V ₃₂₈	V ₃₂₉	V ₃₃₀	V ₃₃₁	V ₃₃₂	V ₃₃₃	V ₃₃₄	V ₃₃₅	V ₃₃₆	V ₃₃₇	V ₃₃₈	V ₃₃₉	V ₃₄₀	V ₃₄₁	V ₃₄₂	V ₃₄₃	V ₃₄₄	V ₃₄₅	V ₃₄₆	V ₃₄₇	V ₃₄₈	V ₃₄₉	V ₃₅₀	V ₃₅₁	V ₃₅₂	V ₃₅₃	V ₃₅₄	V ₃₅₅	V ₃₅₆	V ₃₅₇	V ₃₅₈	V ₃₅₉	V ₃₆₀	V ₃₆₁	V ₃₆₂	V ₃₆₃	V ₃₆₄	V ₃₆₅	V ₃₆₆	V ₃₆₇	V ₃₆₈	V ₃₆₉	V ₃₇₀	V ₃₇₁	V ₃₇₂	V ₃₇₃	V ₃₇₄	V ₃₇₅	V ₃₇₆	V ₃₇₇	V ₃₇₈	V ₃₇₉	V ₃₈₀	V ₃₈₁	V ₃₈₂	V ₃₈₃	V ₃₈₄	V ₃₈₅	V ₃₈₆	V ₃₈₇	V ₃₈₈	V ₃₈₉	V ₃₉₀	V ₃₉₁	V ₃₉₂	V ₃₉₃	V ₃₉₄	V ₃₉₅	V ₃₉₆	V ₃₉₇	V ₃₉₈	V ₃₉₉	V ₄₀₀	V ₄₀₁	V ₄₀₂	V ₄₀₃	V ₄₀₄	V ₄₀₅	V ₄₀₆	V ₄₀₇	V ₄₀₈	V ₄₀₉	V ₄₁₀	V ₄₁₁	V ₄₁₂	V ₄₁₃	V ₄₁₄	V ₄₁₅	V ₄₁₆	V ₄₁₇	V ₄₁₈	V ₄₁₉	V ₄₂₀	V ₄₂₁	V ₄₂₂	V ₄₂₃	V ₄₂₄	V ₄₂₅	V ₄₂₆	V ₄₂₇	V ₄₂₈	V ₄₂₉	V ₄₃₀	V ₄₃₁	V ₄₃₂	V ₄₃₃	V ₄₃₄	V ₄₃₅	V ₄₃₆	V ₄₃₇	V ₄₃₈	V ₄₃₉	V ₄₄₀	V ₄₄₁	V ₄₄₂	V ₄₄₃	V ₄₄₄	V ₄₄₅	V ₄₄₆	V ₄₄₇	V ₄₄₈	V ₄₄₉	V ₄₅₀	V ₄₅₁	V ₄₅₂	V ₄₅₃	V ₄₅₄	V ₄₅₅	V ₄₅₆	V ₄₅₇	V ₄₅₈	V ₄₅₉	V ₄₆₀	V ₄₆₁	V ₄₆₂	V ₄₆₃	V ₄₆₄	V ₄₆₅	V ₄₆₆	V ₄₆₇	V ₄₆₈	V ₄₆₉	V ₄₇₀	V ₄₇₁	V ₄₇₂	V ₄₇₃	V ₄₇₄	V ₄₇₅	V ₄₇₆	V ₄₇₇	V ₄₇₈	V ₄₇₉	V ₄₈₀	V ₄₈₁	V ₄₈₂	V ₄₈₃	V ₄₈₄	V ₄₈₅	V ₄₈₆	V ₄₈₇	V ₄₈₈	V ₄₈₉	V ₄₉₀	V ₄₉₁	V ₄₉₂	V ₄₉₃	V ₄₉₄	V ₄₉₅	V ₄₉₆	V ₄₉₇	V ₄₉₈	V ₄₉₉	V ₅₀₀	V ₅₀₁	V ₅₀₂	V ₅₀₃	V ₅₀₄	V ₅₀₅	V ₅₀₆	V ₅₀₇	V ₅₀₈	V ₅₀₉	V ₅₁₀	V ₅₁₁	V ₅₁₂	V ₅₁₃	V ₅₁₄	V ₅₁₅	V ₅₁₆	V ₅₁₇	V ₅₁₈	V ₅₁₉	V ₅₂₀	V ₅₂₁	V ₅₂₂	V ₅₂₃	V ₅₂₄	V ₅₂₅	V ₅₂₆	V ₅₂₇	V ₅₂₈	V ₅₂₉	V ₅₃₀	V ₅₃₁	V ₅₃₂	V ₅₃₃	V ₅₃₄	V ₅₃₅	V ₅₃₆	V ₅₃₇	V ₅₃₈	V ₅₃₉	V ₅₄₀	V ₅₄₁	V ₅₄₂	V ₅₄₃	V ₅₄₄	V ₅₄₅	V ₅₄₆	V ₅₄₇	V ₅₄₈	V ₅₄₉	V ₅₅₀	V ₅₅₁	V ₅₅₂	V ₅₅₃	V ₅₅₄	V ₅₅₅	V ₅₅₆	V ₅₅₇	V ₅₅₈	V ₅₅₉	V ₅₆₀	V ₅₆₁	V ₅₆₂	V ₅₆₃	V ₅₆₄	V ₅₆₅	V ₅₆₆	V ₅₆₇	V ₅₆₈	V ₅₆₉	V ₅₇₀	V ₅₇₁	V ₅₇₂	V ₅₇₃	V ₅₇₄	V ₅₇₅	V ₅₇₆	V ₅₇₇	V ₅₇₈	V ₅₇₉	V ₅₈₀	V ₅₈₁	V ₅₈₂	V ₅₈₃	V ₅₈₄	V ₅₈₅	V ₅₈₆	V ₅₈₇	V ₅₈₈	V ₅₈₉	V ₅₉₀	V ₅₉₁	V ₅₉₂	V ₅₉₃	V ₅₉₄	V ₅₉₅	V ₅₉₆	V ₅₉₇	V ₅₉₈	V ₅₉₉	V ₆₀₀	V ₆₀₁	V ₆₀₂	V ₆₀₃	V ₆₀₄	V ₆₀₅	V ₆₀₆	V ₆₀₇	V ₆₀₈	V ₆₀₉	V ₆₁₀	V ₆₁₁	V ₆₁₂	V ₆₁₃	V ₆₁₄	V ₆₁₅	V ₆₁₆	V ₆₁₇	V ₆₁₈	V ₆₁₉	V ₆₂₀	V ₆₂₁	V ₆₂₂	V ₆₂₃	V ₆₂₄	V ₆₂₅	V ₆₂₆	V ₆₂₇	V ₆₂₈	V ₆₂₉	V ₆₃₀	V ₆₃₁	V ₆₃₂	V ₆₃₃	V ₆₃₄	V ₆₃₅	V ₆₃₆	V ₆₃₇	V ₆₃₈	V ₆₃₉	V ₆₄₀	V ₆₄₁	V ₆₄₂	V ₆₄₃	V ₆₄₄	V ₆₄₅	V ₆₄₆	V ₆₄₇	V ₆₄₈	V ₆₄₉	V ₆₅₀	V ₆₅₁	V ₆₅₂	V ₆₅₃	V ₆₅₄	V ₆₅₅	V ₆₅₆	V ₆₅₇	V ₆₅₈	V ₆₅₉	V ₆₆₀	V ₆₆₁	V ₆₆₂	V ₆₆₃	V ₆₆₄	V ₆₆₅	V ₆₆₆	V ₆₆₇	V ₆₆₈	V ₆₆₉	V ₆₇₀	V ₆₇₁	V ₆₇₂	V ₆₇₃	V ₆₇₄	V ₆₇₅	V ₆₇₆	V ₆₇₇	V ₆₇₈	V ₆₇₉	V ₆₈₀	V ₆₈₁	V ₆₈₂	V ₆₈₃	V ₆₈₄	V ₆₈₅	V ₆₈₆	V ₆₈₇	V ₆₈₈	V ₆₈₉	V ₆₉₀	V ₆₉₁	V ₆₉₂	V ₆₉₃	V ₆₉₄	V ₆₉₅	V ₆₉₆	V ₆₉₇	V ₆₉₈	V ₆₉₉	V ₇₀₀	V ₇₀₁	V ₇₀₂	V ₇₀₃	V ₇₀₄	V ₇₀₅	V ₇₀₆	V ₇₀₇	V ₇₀₈	V ₇₀₉	V ₇₁₀	V ₇₁₁	V ₇₁₂	V ₇₁₃	V ₇₁₄	V ₇₁₅	V ₇₁₆	V ₇₁₇	V ₇₁₈	V ₇₁₉	V ₇₂₀	V ₇₂₁	V ₇₂₂	V ₇₂₃	V ₇₂₄	V ₇₂₅	V ₇₂₆	V ₇₂₇	V ₇₂₈	V ₇₂₉	V ₇₃₀	V ₇₃₁	V ₇₃₂	V ₇₃₃	V ₇₃₄	V ₇₃₅	V ₇₃₆	V ₇₃₇	V ₇₃₈	V ₇₃₉	V ₇₄₀	V ₇₄₁	V ₇₄₂	V ₇₄₃	V ₇₄₄	V ₇₄₅	V ₇₄₆	V ₇₄₇	V ₇₄₈	V ₇₄₉	V ₇₅₀	V ₇₅₁	V ₇₅₂	V ₇₅₃	V ₇₅₄	V ₇₅₅	V ₇₅₆	V ₇₅₇	V ₇₅₈	V ₇₅₉	V ₇₆₀	V ₇₆₁	V ₇₆₂	V ₇₆₃	V ₇₆₄	V ₇₆₅	V ₇₆₆	V ₇₆₇	V ₇₆₈	V ₇₆₉	V ₇₇₀	V ₇₇₁	V ₇₇₂	V ₇₇₃	V ₇₇₄	V ₇₇₅	V ₇₇₆	V ₇₇₇	V ₇₇₈	V ₇₇₉	V ₇₈₀	V ₇₈₁	V ₇₈₂	V ₇₈₃	V ₇₈₄	V ₇₈₅	V ₇₈₆	V ₇₈₇	V ₇₈₈	V ₇₈₉	V ₇₉₀	V ₇₉₁	V ₇₉₂	V ₇₉₃	V ₇₉₄	V ₇₉₅	V ₇₉₆	V ₇₉₇	V ₇₉₈	V ₇₉₉	V ₈₀₀	V ₈₀₁	V ₈₀₂	V ₈₀₃	V ₈₀₄	V ₈₀₅	V ₈₀₆	V ₈₀₇	V ₈₀₈	V ₈₀₉	V ₈₁₀	V ₈₁₁	V ₈₁₂	V ₈₁₃	V ₈₁₄	V ₈₁₅	V ₈₁₆	V ₈₁₇	V ₈₁₈	V ₈₁₉	V ₈₂₀	V ₈₂₁	V ₈₂₂	V ₈₂₃	V ₈₂₄	V ₈₂₅	V ₈₂₆	V ₈₂₇	V ₈₂₈	V ₈₂₉	V ₈₃₀	V ₈₃₁	V ₈₃₂	V ₈₃₃	V ₈₃₄	V ₈₃₅	V ₈₃₆	V ₈₃₇	V ₈₃₈	V ₈₃₉	V ₈₄₀	V ₈₄₁	V ₈₄₂	V ₈₄₃	V ₈₄₄	V ₈₄₅	V ₈₄₆	V ₈₄₇	V ₈₄₈	V ₈₄₉	V ₈₅₀	V ₈₅₁	V ₈₅₂	V ₈₅₃	V ₈₅₄	V ₈₅₅	V ₈₅₆	V ₈₅₇	V ₈₅₈	V ₈₅₉	V ₈₆₀	V ₈₆₁	V ₈₆₂	V ₈₆₃	V ₈₆₄	V ₈₆₅	V ₈₆₆	V ₈₆₇	V ₈₆₈	V ₈₆₉	V ₈₇₀	V ₈₇₁	V ₈₇₂	V ₈₇₃	V ₈₇₄

PAL/NTSC VIDEO CHROMA DEFLECTION

ELECTRICAL CHARACTERISTICS TEST METHOD**GY** Video amplifier gain

1. Test-Y output amplitude and make V_{CO} the testing value.

$$2. GY = 20 \times \log \frac{V_{CO}(mV_{P-P})}{200(mV_{P-P})} \text{ (dB)}$$

GYMID 1 GYMAX Contrast control characteristics-1

1. $GY_{MID} 1 = V_{CO}(V_{P-P})$

2. Test-Y output amplitude and make V_{C1} the testing value.

$$3. GY_{MAX} = 20 \times \log \frac{V_{C1}(mV_{P-P})}{V_{CO}(mV_{P-P})} \text{ (dB)}$$

GYMIN Contrast control characteristics-2

1. Test-Y output amplitude and make V_{C2} the testing value.

$$2. GY_{MIN} = 20 \times \log \frac{V_{C2}(mV_{P-P})}{V_{CO}(mV_{P-P})} \text{ (dB)}$$

GYMID 2 Contrast control characteristics-3

1. Test-Y output amplitude and make V_{C3} the testing value.

$$2. GY_{MID} 2 = 20 \times \log \frac{V_{C3}(mV_{P-P})}{V_{CO}(mV_{P-P})} \text{ (dB)}$$

YTMID Video tone control characteristics-1

1. Test-Y output amplitude and make V_{T0} the testing value.

2. $Y_{TMID} = V_{T0}(V_{P-P})$

YTMIN Video tone control characteristics-2

1. Test-Y output amplitude and make V_{T1} the testing value.

$$2. Y_{TMIN} = 20 \times \log \frac{V_{T1}(mV_{P-P})}{V_{T0}(mV_{P-P})} \text{ (dB)}$$

YTMAX Video tone control characteristics-3

1. Test-Y output amplitude and make V_{T2} the testing value.

$$2. Y_{TMAX} = 20 \times \log \frac{V_{T2}(mV_{P-P})}{V_{T0}(mV_{P-P})} \text{ (dB)}$$

YBRTMID Luminance control characteristics-1

1. Test-Y output DC voltage.

YBRTMIN Luminance control characteristics-2

1. Same as Y9

YBRTMAX Luminance control characteristics-3

1. Same as Y9

Yf Frequency characteristics

1. Test-Y output amplitude.

2. Make V_{f1} the amplitude when SG2 is input.

3. Make V_{f2} the amplitude when SG4 is input.

$$4. Y_f = 20 \times \log \frac{V_{f2}}{V_{f1}} \text{ (dB)}$$

DG Differential gain

1. Test-Y output DC voltage.

2. Make V_{G1} the amplitude when pin ④ is set 2.4V.

3. Make V_{G2} the amplitude when pin ④ is set 1.8V.

$$4. DG = \frac{|V_{G1} - V_{G2}|}{V_{G2}} \times 100 \text{ (\%)}$$

H.BLK TH Horizontal blanking threshold voltage

1. Apply voltage to pin ④ and increase from 8V.

2. Test the voltage of pin ④ when signal ceases to be output by ①A.

GC Chroma maximum gain

1. Test output amplitude (P-P) and make V_{GC} the testing value.

2. Input amplitude.

$$GC = 20 \times \log \frac{V_{GC} (mV_{P-P})}{\text{Input amplitude } (= 7.94mV_{P-P})} \text{ (dB)}$$

ACC 1 ACC characteristics-1

1. Test output amplitude (P-P).

2. Make V_{A0} the testing value when SG5 0dB is input.

3. Make V_{A1} the testing value when SG5 -20dB is input.

$$4. ACC 1 = 20 \times \log \frac{V_{A1}}{V_{A0}} \text{ (dB)}$$

ACC 2 ACC characteristics-2

1. In the same manner as in C3, make V_{A2} the testing value when SG5 +6dB is input.

$$2. ACC 2 = 20 \times \log \frac{V_{A2}}{V_{A0}} \text{ (dB)}$$

KIL Killer operation input

1. Gradually attenuate the level of SG5.

2. While monitoring DC voltage of pin ⑥, input level of SG5 when voltage becomes less than 1V.

D KIL Killer color residual

1. Test output amplitude within 1H interval.

CCMID 1 CCMAX color control characteristics-1

1. Test output amplitude (P-P) and make V_{C10} the testing value.

2. $CCMID 1 = V_{C10} (V_{P-P})$

3. Test output amplitude (P-P) and make V_{C11} the testing value.

$$4. CCMAX = 20 \times \log \frac{V_{C11}}{V_{C10}} \text{ (dB)}$$

CCMIN Color control characteristics-2

1. Test output amplitude (P-P) and make V_{C12} the testing value.

$$2. CCMIN = 20 \times \log \frac{V_{C12}}{V_{C10}} \text{ (dB)}$$

PAL/NTSC VIDEO CHROMA DEFLECTION

CCMID 2 Color control characteristics-3

1. Test output amplitude (P-P) and make V_{C13} the testing value.
2. $CCMID\ 2 = 20 \times \log \frac{V_{C13}}{V_{C10}}$ (dB)

UCMID 1 UCMAX color tracking characteristics-1

1. Test output amplitude (P-P) and make V_{U0} the testing value.
2. $UCMID\ 1 = V_{U0}$ (V_{P-P})
3. Test output amplitude (P-P) and make V_{U1} the testing value.
4. $UCMAX = 20 \times \log \frac{V_{U1}}{V_{U0}}$ (dB)

UCMIN Color tracking characteristics-2

1. Test output amplitude (P-P) and make V_{U2} the testing value.
2. $UCMIN = 20 \times \log \frac{V_{U2}}{V_{U0}}$ (dB)

UCMID 2 Color tracking characteristics-3

1. Test output amplitude (P-P) and make V_{U3} the testing value.
2. $UCMID = 20 \times \log \frac{V_{U3}}{V_{U0}}$ (dB)

APC 1 APC pull-in range-1

1. Set so that the frequency of SG6 is less than 4.433MHz and pin ⑥ is Lo.
2. Gradually increase the frequency of SG6.
3. Test the frequency when the voltage of pin ⑥ changes from Lo to Hi and make $F_{A\mu}$ the testing value.
4. $APC\ 1 = 4433619(\text{Hz}) - F_{A\mu}(\text{Hz})$

APC 2 APC pull-in range-2

1. Set so that the frequency of SG6 is more than 4.434MHz and pin ⑥ is Lo.
2. Gradually decrease the frequency of SG6.
3. Test the frequency when the voltage of pin ⑥ changes from Lo to Hi and make F_{Ad} the testing value.
4. $APC\ 2 = F_{Ad}(\text{Hz}) - 4433619(\text{Hz})$

DDC Demodulated output DC voltage

1. Test DC voltage at ①A, ②A, and ③A.

D OFF Demodulated output DC offset

1. Calculate each voltage difference of ①A②A, ②A③A, ③A①A from the testing value of C15.

RB Demodulation ratio-1

1. Test output amplitude and make DR-Y testing value.
2. $RB = \frac{DR-Y}{DB-Y(\text{Testing value at C18})}$ (dB)

DB Demodulation ratio-2

1. Test output amplitude and make D_{G-Y} the testing value.
2. $GB = \frac{D_{G-Y}}{DB-Y(\text{Testing value at C18})}$ (dB)

DDH Demodulated output 1H level difference

1. Test both AC, DC for each 1H level difference.

CL Demodulated output carrier leak

1. Test output carrier element for ①A, ②A, and ③A.

VN NTSC operation control voltage

1. Gradually decrease voltage of ④A from the area of 8V.
2. Test the ④A voltage when signal ceases to be output by ①A.

NTSC R/B Demodulation ratio (NTSC)-1

1. Test output amplitude and make NTSC_R the testing value.
2. $NTSC\ R/B = \frac{NTSC_R}{NTSC_R(\text{Testing value at C25})}$

NTSC G/B Demodulation ratio (NTSC)-2

1. Test output amplitude and make NTSC_R the testing value.
2. $NTSC\ R/B = \frac{NTSC_R}{NTSC_R(\text{Testing value at C25})}$

VP/N PAL/NTSC demodulated output DC voltage difference

1. Test the difference in DC voltage when (S34) is on and when it is OFF.

SS Service switch operation

1. No output signal from ④.
2. No vertical sync pulse from ⑤.
3. Voltage of ⑥ drops below 1V.
4. Check 1, 2, and 3.

DBW Demodulated output bandwidth

1. Set frequency of SG8 to 4.5MHz, and test output amplitude of ①, ② and ③.
2. Gradually increase the frequency of SG8.
3. Test output frequency of ①, ②, and ③ when output amplitude is 3dB less than when 4.5MHz is input.

CD Chroma input dynamic range

1. Increase the level of SG5 and test the input amplitude when output become distorted.

RYP, GYP Pal demodulated phase angle

1. Make R-Y-P the phase difference of ①A, ②A.
2. Make G-Y-P the phase difference of ①A, ③A.

RYN, GYN NTSC Demodulated phase angle

1. Make R-Y-N the phase difference of ①A, ②A.
2. Make G-Y-N the phase difference of ①A, ③A.

PAL/NTSC VIDEO CHROMA DEFLECTION

TMIN, TMAX NTSC Tint

1. Set oscilloscope to X-Y. Connect (A) to X and (2A) to Y.
2. Open (34A) and set SGB frequency to 4.433619MHz.
3. At this time the oscilloscope waveform is shown as 180°.
4. Make TMIN the remainder of subtracting 180° from the angle when (34A) was set to 4V.
5. Make TMAX the remainder of subtracting 180° from the angle when (34A) was set to 1V.

V9MIN Horizontal oscillator starting voltage

1. Increase (VCC) from 0V.
2. Test (VCC) voltage where the output waveform cycle of pin (6) is approx 64µs.

F PHL, F PHH Horizontal pull-in range-1

1. Decrease the frequency of input signal so that the SGB input signal and pin (6) output waveform are not synchronized.
2. Increase the frequency of SGB.
3. Test the SGB frequency when SGB and pin (6) output waveforms become synchronized and make FL1 the testing value.
4. (Testing value at J3)
5. Test the upper side pull-in the same manner and make FH1 the SGB frequency when the two become synchronized.
6. (Testing value at J3)

TH Horizontal output pulse amplitude

VH MIN, VH MAX Horizontal output voltage

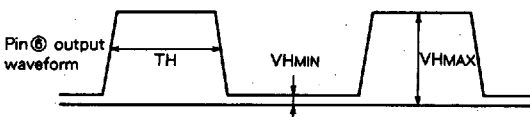

TPG Burst gate pulse position

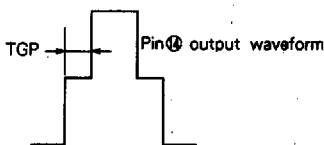

FPV50 Vertical pull-in range 50(Hz)

1. Increase the frequency of input signal so that the SGC input signal and pin (5) output waveform are not synchronized.
2. Decrease the frequency of SGC and test the SGC frequency when SGC and the output waveform of pin (5) become synchronized.

FPV60 Vertical pull-in range 60(Hz)

1. Same as J12.

TV50 Vertical output pulse amplitude 50(Hz)

TV60 Vertical output pulse amplitude 60(Hz)

VVMAX Vertical output maximum voltage

VVMIN Vertical output minimum voltage

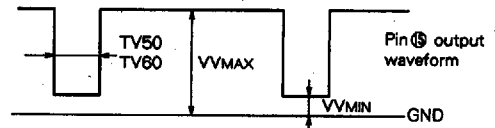

PR Ramp peak voltage

VR Ramp amplitude

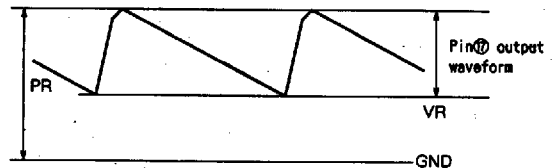

GvV Vertical open loop gain

1. Test the output amplitude of pin (5) and make Vvo the testing value.

$$2. GvV = 20 \times \log \frac{V_{vo}(mV_{P-P})}{\text{Input amplitude}(= 50mV_{P-P})} \text{ (dB)}$$

Iss Sync separation input sensitivity current

1. Increase I_{ss} from 0mA.
2. Test I_{ss} when burst gate pulse ceases to be output by (14).

TBGP 1 Burst gate pulse timing-1

1. Test the time from SGA rise to burst gate pulse rise.

TBGP 2 Burst gate pulse timing-2

1. Test burst gate pulse amplitude.

VFBP Flyback pulse clamp voltage

VBGP Burst gate pulse voltage



PAL/NTSC VIDEO CHROMA DEFLECTION

INPUT SIGNAL

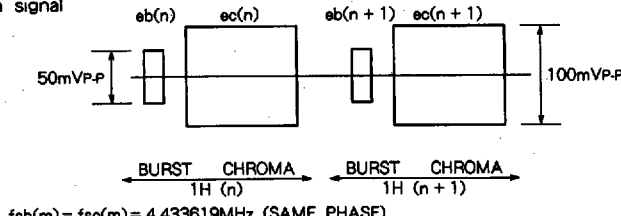
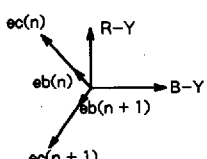
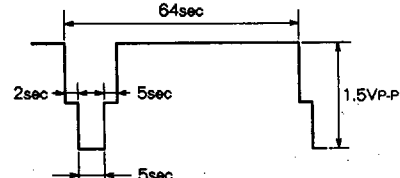
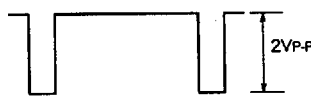
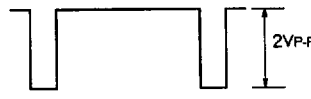
SG. No.	Signal		
SG 1	100kHz	CW	3V _{PP}
SG 2	100kHz	CW	200mV _{PP}
SG 3	2MHz	CW	200mV _{PP}
SG 4	5MHz	CW	200mV _{PP}
SG 5	<p>PAL simple chroma signal</p>  <p>$f_{sb(m)} = f_{sc(m)} = 4.433619\text{MHz (SAME PHASE)}$</p> <p>The phase correlation between the about signal is outlined in the figure on the right. The phase correlation with burst of $ec(n)$ and $ec(n+1)$ does not always have to be as shown in the figure on the right, and in particular must be adjustable according to conditions when testing phase correlation.</p> 		
SG 6	With PAL simple chroma signals for SG5, the phase of burst and chroma signals should be the same and the frequency should be adjustable.		
SG 7	4.42MHz	CW	0.2~0.5V _{PP}
SG 8	4~6MHz	CW	
SG 9	$f_{sb}(\text{Burst}) = 4.433619\text{MHz}$, $f_{sc}(\text{Chroma}) = 4.53\text{MHz}$ at SG5.		
SG a	<p>Input for sync separation should be APL 100% standard combined image signal 1.5V_{PP} for PAL system such as illustrated by the figure on the right.</p> 		
SG b	 <p>Duty 90%</p>		
SG c	 <p>Duty 95%</p>		
SG d	2kHz, CW ; 500mV _{PP} = 0dB		

TYPICAL CHARACTERISTICS

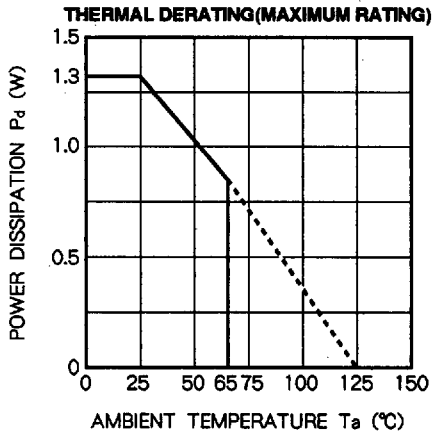





PAL/NTSC VIDEO CHROMA DEFLECTION

DESCRIPTION OF PIN

Pin No.	Name	Description	Peripheral circuit of pins	DC voltage(V)
① ②	B-Y OUTPUT R-Y OUTPUT	<ul style="list-style-type: none"> • Chroma output B-Y R-Y 		6.4
③	G-Y OUTPUT	<ul style="list-style-type: none"> • Chroma output G-Y • If color tracking switch external resistor (emitter resistor) is removed, color tracking is ineffectual. 		6.4
④	-Y OUTPUT	<ul style="list-style-type: none"> • -Y output • Horizontal blanking input 		-
⑤	GND	-	-	0
⑥	HORIZONTAL OUTPUT	<p>Approx. 4V 0V 25μs</p> <p>Horizontal pre-driver output</p>		-
⑦	X-RAY PROTECTOR	X-RAY protector is actuated when pin voltage exceeds approx. 0.75V.		-

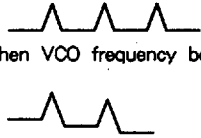
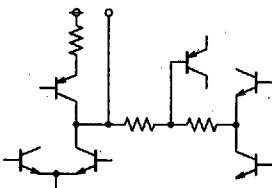

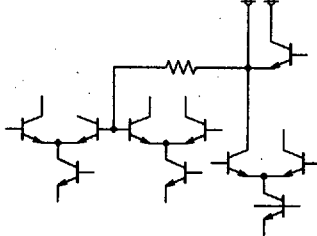
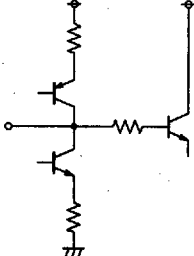

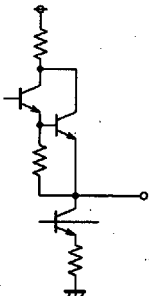
PAL/NTSC VIDEO CHROMA DEFLECTION

DESCRIPTION OF PIN (Cont.)

Pin No.	Name	Description	Peripheral circuit of pins	DC voltage(V)
⑧	AFC1 FILTER	 <p>When VCO frequency becomes high</p> <p>Filter voltage decreases causing VCO frequency to drop. Operates oppositely when frequency become high.</p>		6.6
⑨	Vcc H	Built-in regulator	-	10
⑩	HORIZONTAL RAMP	 <p>Generates horizontal ramp. Horizontal output pulse is created according to this ramp.</p>		-
⑪	COINCIDENCE DETECTION FILTER	High when horizontal SYNC and horizontal output are synchronized, low when not synchronized.		Low 0.2 High 9.1
⑫	HORIZONTAL OSCILLATOR OUTPUT	 <p>f = approx. 500kHz Output to external phase shifter.</p>		9.5

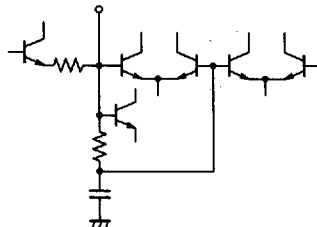
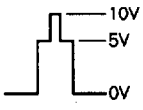
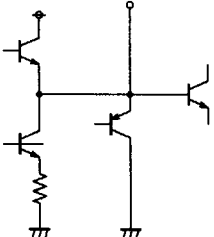
PAL/NTSC VIDEO CHROMA DEFLECTION

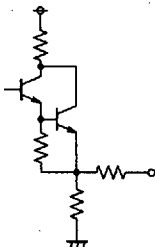
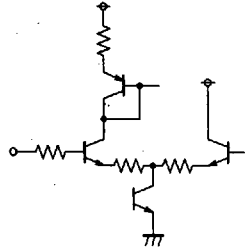
DESCRIPTION OF PIN (Cont.)

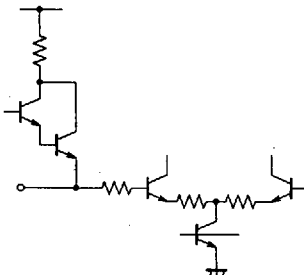
Pin No.	Name	Description	Peripheral circuit of pins	DC voltage(V)
⑬	HORIZONTAL OSCILLATOR INPUT	 f = approx. 500kHz Output to external phase shifter.		5.2
⑭	F.B.P. INPUT/ B.G.P. OUTPUT	4.3μs  B.G.P. and f.b.p. output as sandcastle.		-
⑮	VERTICAL OUTPUT	 5.3V 0V		-
⑯	VERTICAL RETURN	AC/DC return input pin		-
⑰	VERTICAL RAMP	 6.8V 5V Vertical ramp generation		-

DESCRIPTION OF PIN (Cont.)

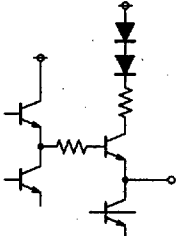
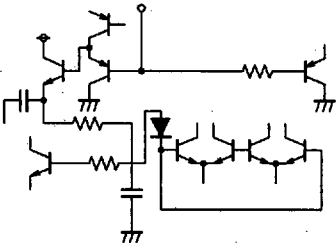
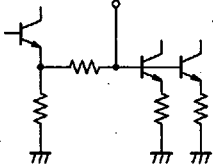
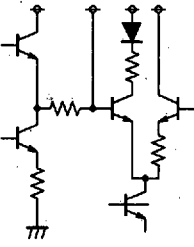
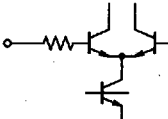
Pin No.	Name	Description	Peripheral circuit of pins	DC voltage(V)
⑮	SYNC SEPARATION INPUT	Sync separation of emitter input		8.4
⑯	PICTURE QUALITY CONTROL/ PICTURE MUTING SWITCH	<ul style="list-style-type: none"> Picture quality control High-pass increases as pin voltage is decreased. Picture muting If voltage is less than 2V, picture muting is actuated and -Y output become BLK level. Built-in buffer 		-
⑳	Y INPUT	Y signal input		1.3
㉑	PEDESTAL CLAMP	Pedestal DC voltage of -Y output is determined by this clamp voltage.		2
㉒	LUMINANCE CONTROL	Luminance control Become brighter as voltage is increased.		-

PAL/NTSC VIDEO CHROMA DEFLECTION

DESCRIPTION OF PIN (Cont.)

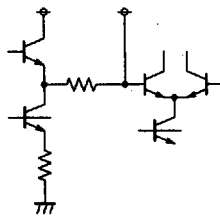
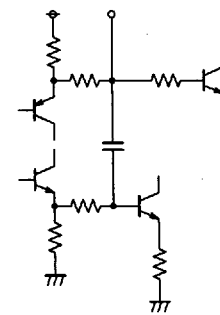
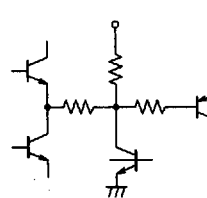
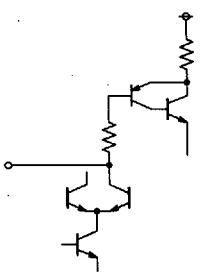
Pin No.	Name	Description	Peripheral circuit of pins	DC voltage(V)
23	DC PLAYBACK	DC playback ratio can be changed by external CR. 100% when open.		-
24	Vcc	-	-	11
25	COLOR SIGNAL INPUT 50/60 SW	<ul style="list-style-type: none"> • Chroma input • 50/60 switching Vertical countdown toggles between 50Hz and 60Hz. When voltage exceeds 5.6V, toggles to 60Hz.		2.7 -
26	COLOR SATURATION CONTROL	Changes amplitude of chroma output.		-
27	PEAK ACC FILTER	Gain of chroma amp is controlled by this filter in order to maintain a constant chroma amplitude.		-

PAL/NTSC VIDEO CHROMA DEFLECTION

DESCRIPTION OF PIN (Cont.)

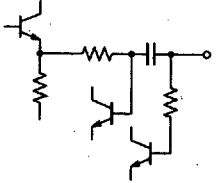
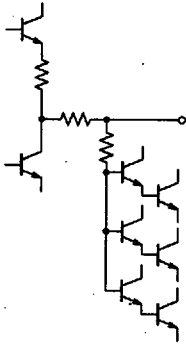
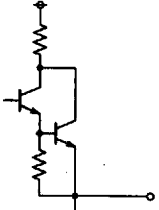
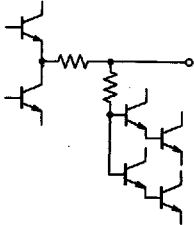
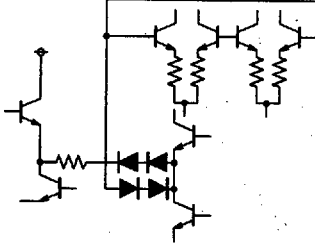
Pin No.	Name	Description	Peripheral circuit of pins	DC voltage(V)
②	CONTRAST CONTROL/ BURST CHEANING	Burst cleaning Coil connection contrast control Changes amplitude of -Y output. Amplitude increases as voltage is increased.		-
③	ACC/KILLER (1) / SERVICE SWITCH	Sync acc/killer filter ACC and killer are operated according to voltage differential between this pin and pin ④. When this pin is connected to GND, the service switch is ON. (Vertical stop and cotrast MIN, killer ON.)		7.3
④	CHROM OUTPUT	PAL system ACC chroma signals are output. NTSC system Low DC chroma signals are output.		7.1 4.2
⑤	ACC/KILLER FILTER (2)	Sync acc/killer filter ACC and killer are operated according to voltage differential between this pin and pin ③.		7.3
⑥	APC FILTER	Chroma VCO phase is controlled by this voltage in order to check burst.		9.1

PAL/NTSC VIDEO CHROMA DEFLECTION

DESCRIPTION OF PIN (Cont.)

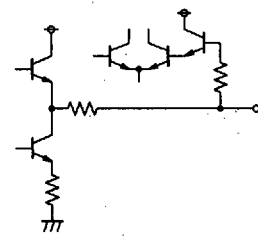
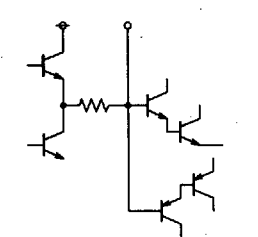
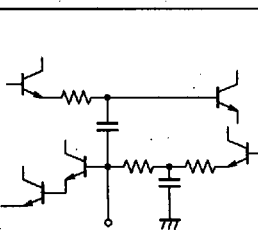
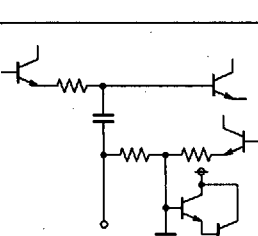
Pin No.	Name	Description	Peripheral circuit of pins	DC voltage(V)
③③	CHROMA VCO	Generates carrier for chroma.		8
③④	IDENT FILTER/ NTSC TINT CONTROL	PAL system Functions as ident filter. When voltage drops below reference voltage, F.F. is stopped. NTSC system (less than 5V) Tint control is carried out at 2~4V. If NTSC switch is less than 5V, switches to NTSC mode.		8
③⑤	B - Y INPUT	PAL system Synthesized B - Y chroma signal input		6
③⑥	R - Y INPUT	PAL system Synthesized R - Y chroma signal input.		2