

M57729

430-450MHz, 12.5V, 30W, FM MOBILE RADIO

OUTLINE DRAWING

Dimensions in mm

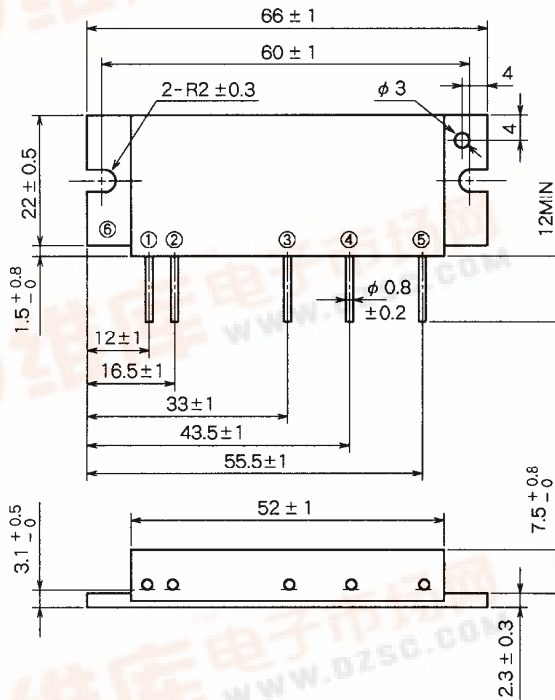

BLOCK DIAGRAM

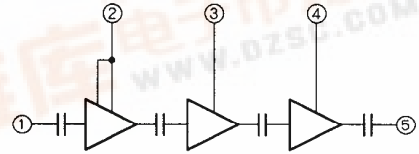

PIN :

- ① Pin : RF INPUT
- ② Vcc1 : 1st. DC SUPPLY
- ③ Vcc2 : 2nd. DC SUPPLY
- ④ Vcc3 : 3rd. DC SUPPLY
- ⑤ Po : RF OUTPUT
- ⑥ GND : FIN

ABSOLUTE MAXIMUM RATINGS (T_c = 25 °C unless otherwise noted)

Symbol	Parameter	Conditions	Ratings	Unit
V _{cc}	Supply voltage		17	V
I _{cc}	Total current		10	A
P _{in(max)}	Input power	Z _G = Z _L = 50 Ω	0.6	W
P _{o(max)}	Output power	Z _G = Z _L = 50 Ω	40	W
T _{c(OP)}	Operation case temperature		- 30 to 110	°C
T _{stg}	Storage temperature		- 40 to 110	°C

Note. Above parameters are guaranteed independently.

ELECTRICAL CHARACTERISTICS (T_c = 25 °C unless otherwise noted)

Symbol	Parameter	Test conditions	Limits		Unit
			Min	Max	
f	Frequency range		430	450	MHz
P _o	Output power	P _{in} = 0.3W V _{cc} = 12.5V Z _G = Z _L = 50 Ω	30		W
η _T	Total efficiency		40		%
2f _o	2nd. harmonic			- 30	dBc
3f _o	3rd. harmonic			- 30	dBc
ρ _{in}	Input VSWR			2.8	-
-	Load VSWR tolerance	V _{cc} = 15.2V, P _o = 30W (P _{in} : controlled) Load VSWR=20:1 (All phase), 2sec. Z _G = 50 Ω	No degradation or destroy		-

Note. Above parameters, ratings, limits and conditions are subject to change.

OUTPUT POWER, TOTAL EFFICIENCY, INPUT VSWR VS. FREQUENCY (M57729)

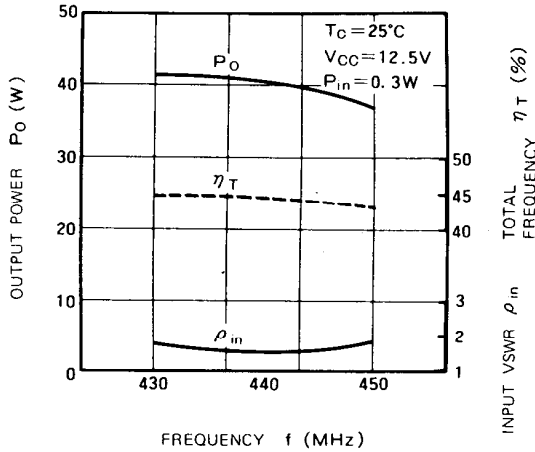

OUTPUT POWER, TOTAL EFFICIENCY, VS. INPUT POWER (M57729)

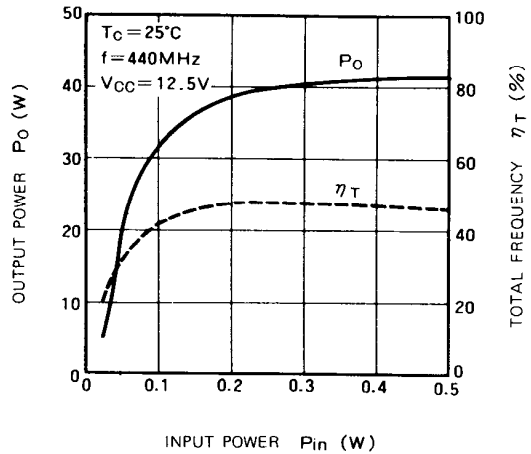

OUTPUT POWER VS. DC SUPPLY VOLTAGE (M57729)

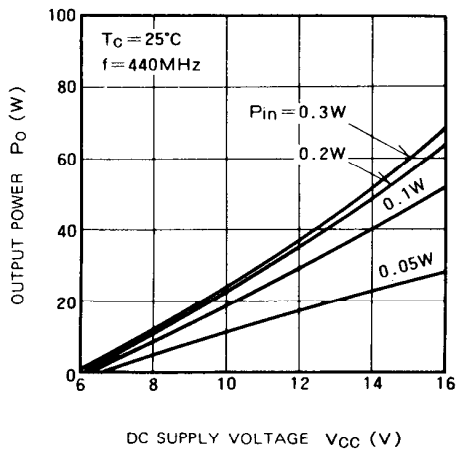

OUTPUT POWER VS. 1st VOLTAGE (M57729)

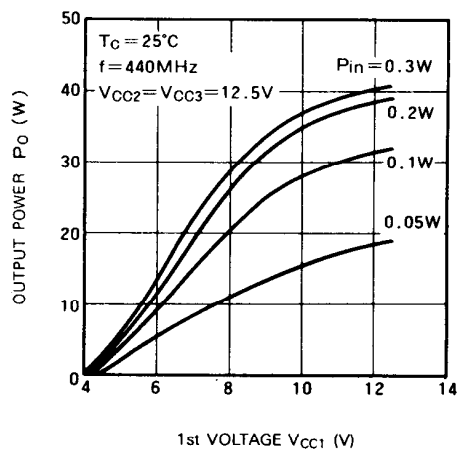

INPUT IMPEDANCE, OUTPUT IMPEDANCE VS. FREQUENCY (M57729)

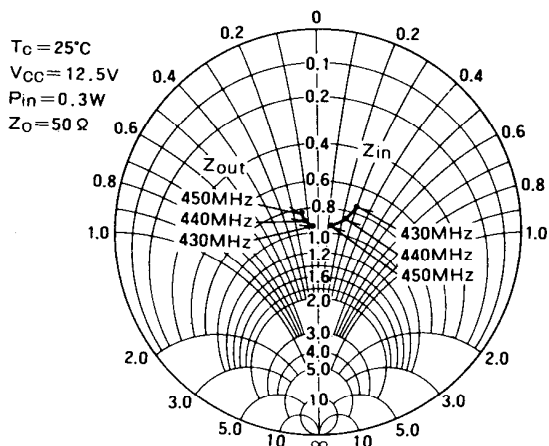

DESIGN CONSIDERATION OF HEAT RADIATION

Please refer to following consideration when designing heat sink.

1. Junction temperature of incorporated transistors at standard operation.

(1) Thermal resistance between junction and package of incorporated transistors.

- a) First stage transistor
 $R_{th(j-c)1} = 12^{\circ}\text{C/W}$ (Typ.)
- b) Second stage transistor
 $R_{th(j-c)2} = 4^{\circ}\text{C/W}$ (Typ.)
- c) Final stage transistor
 $R_{th(j-c)3} = 2^{\circ}\text{C/W}$ (Typ.)

(2) Junction temperature of incorporated transistors at standard operation.

- Conditions for standard operation.
 $P_o = 30\text{W}$, $V_{CC} = 12.5\text{V}$, $P_{in} = 0.3\text{W}$, $\eta_T = 40\%$ (minimum rating), P_{O1} (Note 1) = 2.0W, P_{O2} (2) = 8.0W, $I_T = 6.0\text{A}$ (I_{T1} (3) = 0.35A, I_{T2} (4) = 1.32A, I_{T3} (5) = 4.33A)

- Note 1: Output power of the first stage transistor
- Note 2: Output power of the second stage transistor
- Note 3: Circuit current of the first stage transistor
- Note 4: Circuit current of the second stage transistor
- Note 5: Circuit current of the final stage transistor

- Junction temperature of the first stage transistor
 $T_{j1} = (V_{CC} \times I_{T1} - P_{O1} + P_{in}) \times R_{th(j-c)1} + T_c$ (6)
 $= (12.5 \times 0.35 - 2.0 + 0.3) \times 12 + T_c$
 $= 32 + T_c$ ($^{\circ}\text{C}$)

Note 6: Package temperature of device

- Junction temperature of the second stage transistor
 $T_{j2} = (V_{CC} \times I_{T2} - P_{O2} + P_{O1}) \times R_{th(j-c)2} + T_c$
 $= (12.5 \times 1.32 - 8.0 + 2.0) \times 4 + T_c$
 $= 42 + T_c$ ($^{\circ}\text{C}$)

- Junction temperature of the final stage transistor
 $T_{j3} = (V_{CC} \times I_{T3} - P_o + P_{O2}) \times R_{th(j-c)3} + T_c$
 $= (12.5 \times 4.33 - 30 + 8) \times 2 + T_c$
 $= 64 + T_c$ ($^{\circ}\text{C}$)

2. Heat sink design

In thermal design of heat sink, try to keep the package temperature at the upper limit of the operating ambient temperature (normally $T_a = 60^{\circ}\text{C}$) and at the output power of 7W below 90°C .

The thermal resistance $R_{th(c-a)}$ (7) of the heat sink to realize this:

$$R_{th(c-a)} = \frac{T_c - T_a}{(P_o/\eta_T) - P_o + P_{in}} = \frac{90 - 60}{(30/0.4) - 30 + 0.3}$$

$$= 0.66$$
 ($^{\circ}\text{C/W}$)

Note 7: Inclusive of the contact thermal resistance between device and heat sink

Mounting the heat sink of the above thermal resistance on the device,

$$T_{j1} = 122^{\circ}\text{C}, T_{j2} = 132^{\circ}\text{C}, T_{j3} = 155^{\circ}\text{C} \text{ at } T_a = 60^{\circ}\text{C}, T_c = 90^{\circ}\text{C}.$$

In the annual average of ambient temperature is 30°C ,

$$T_{j1} = 92^{\circ}\text{C}, T_{j2} = 102^{\circ}\text{C}, T_{j3} = 125^{\circ}\text{C}.$$

As the maximum junction temperature of these incorporated transistors T_{jmax} are 175°C , application under fully derated condition is ensured.