



M80C186 CHMOS HIGH INTEGRATION 16-BIT MICROPROCESSOR

Military

- **Operation Modes Include:**
 - Enhanced Mode Which Has
 - DRAM Refresh
 - Power-Save Logic
 - Direct Interface to New CMOS Numerics Coprocessor
 - Compatible Mode
 - NMOS M80186 Pin-for-Pin Replacement for Non-Numerics Applications
- **Integrated Feature Set**
 - Enhanced M80C86/C88 CPU
 - Clock Generator
 - 2 Independent DMA Channels
 - Programmable Interrupt Controller
 - 3 Programmable 16-Bit Timers
 - Dynamic RAM Refresh Control Unit
 - Programmable Memory and Peripheral Chip Select Logic
 - Programmable Wait State Generator
 - Local Bus Controller
 - Power Save Logic
 - System-Level Testing Support (High Impedance Test Mode)
- **Available in 10 MHz and 12.5 MHz Versions**
- **Direct Addressing Capability to 1 Mbyte and 64 Kbyte I/O**
- **Completely Object Code Compatible with All Existing M8086/M8088 Software and Also Has 10 Additional Instructions over M8086/M8088**
- **Complete System Development Support**
 - All M8086 and NMOS M80186 Software Development Tools Can Be Used for M80C186 System Development
 - Assembler, PL/M, Pascal, Fortran, and System Utilities
 - In-Circuit-Emulator (ICE™-C186)
- **Available in 68-Pin Ceramic Pin Grid Array (PGA) and 68-Lead Ceramic Quad Flat Pack**
(See Packaging Outlines and Dimensions, Order # 231369)
- **Available in Two Product Grades:**
 - MIL-STD-883, -55°C to +125°C (T_C)
 - Military Temperature Only (MTO), -55°C to +125°C (T_C)

The Intel M80C186 is a CHMOS high integration microprocessor. It has features which are new to the M80186 family which include a DRAM refresh control unit, power-save mode and a direct numerics interface. When used in "compatible" mode, the M80C186 is 100% pin-for-pin compatible with the NMOS M80186 (except for M8087 applications). The "enhanced" mode of operation allows the full feature set of the M80C186 to be used. The M80C186 is upward compatible with M8086 and M8088 software and fully compatible with M80186 and M80188 software.

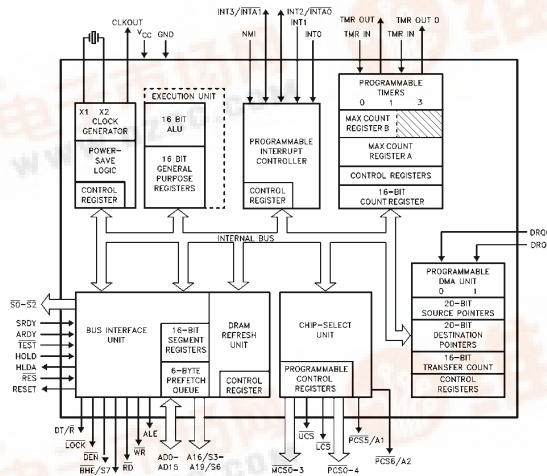

Figure 1. M80C186 Block Diagram

270500-1



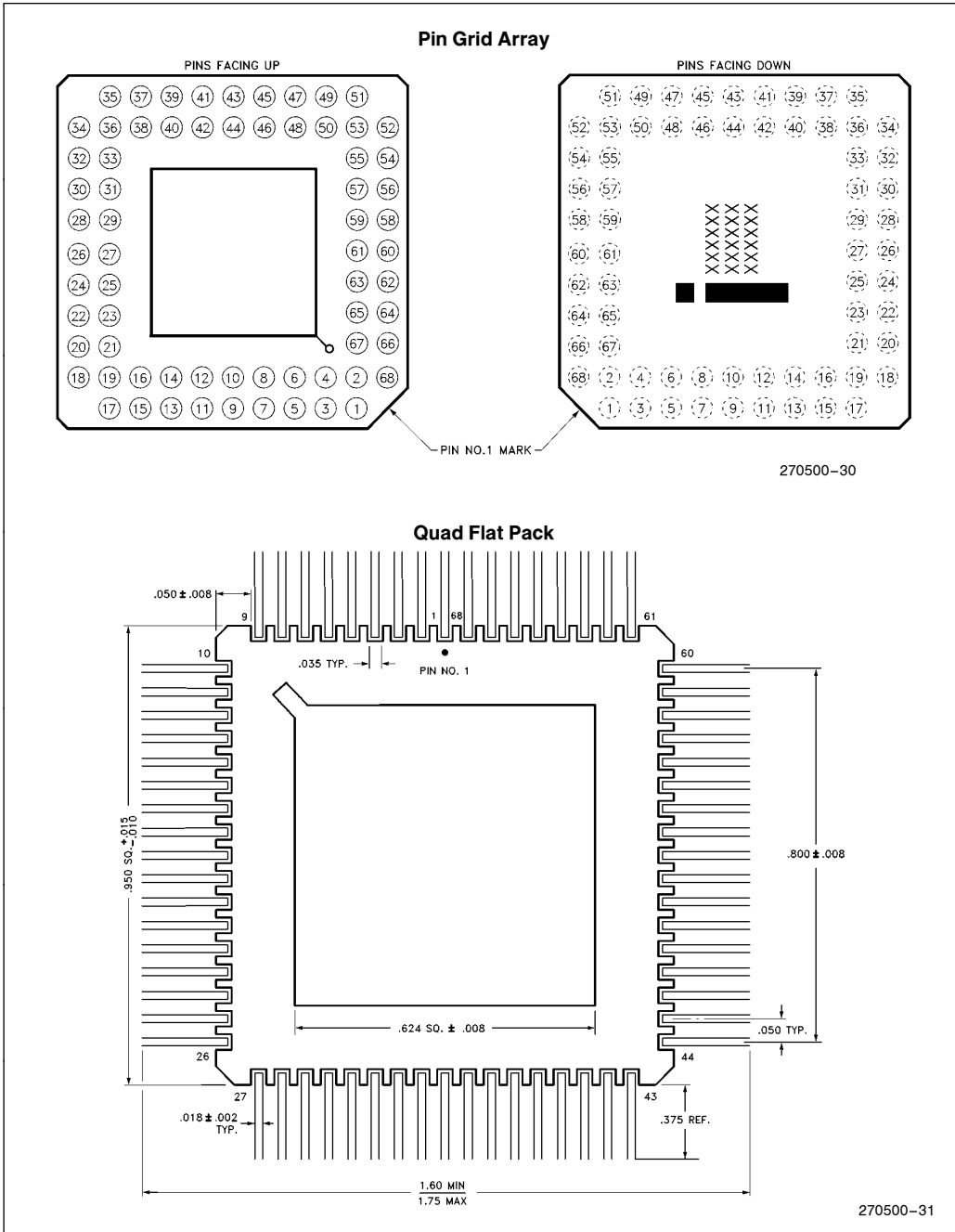

Figure 2. M80C186 Pinout Diagram

For additional packaging information refer to "Packaging Outlines and Dimensions", Order Number 231369

Table 1. M80C186 Pin Description

Symbol	PGA	QFP	Type	Name and Function
V _{CC} , V _{CC}	9, 43	1, 35	I	System Power: + 5 volt power supply.
V _{SS} , V _{SS}	26, 60	52, 18	I	System Ground.
RESET	57	21	O	Reset Output indicates that the M80C186 CPU is being reset, and can be used as a system reset. It is active HIGH, synchronized with the processor clock, and lasts an integer number of clock periods corresponding to the length of the RES signal. Reset goes inactive 2 clockout periods after RES goes inactive. When tied to the TEST/BUSY pin, Reset forces the M80C186 into enhanced mode.
X1, X2	59, 58	19, 20	I	Crystal Inputs X1 and X2 provide external connections for a fundamental mode or third overtone parallel resonant crystal for the internal oscillator. X1 can connect to an external clock instead of a crystal. In this case, minimize the capacitance on X2 or drive X2 with complemented X1. The input or oscillator frequency is internally divided by two to generate the clock signal (CLKOUT).
CLKOUT	56	22	O	Clock Output provides the system with a 50% duty cycle waveform. All device pin timings are specified relative to CLKOUT. CLKOUT has sufficient MOS drive capabilities for the Numeric Processor Extension.
RES	24	54	I	System Reset causes the M80C186 to immediately terminate its present activity, clear the internal logic, and enter a dormant state. This signal may be asynchronous to the M80C186 clock. The M80C186 begins fetching instructions approximately 7 clock cycles after RES is returned HIGH. For proper initialization, V _{CC} must be within specifications and the clock signal must be stable for more than 4 clocks with RES held LOW. RES is internally synchronized. This input is provided with a Schmitt-trigger to facilitate power-on RES generation via an RC network. When RES occurs, the M80C186 will drive the status lines to an inactive level for one clock, and then float them.
TEST/BUSY	47	31	I	<p>The TEST pin is sampled during and after reset to determine whether the M80C186 is to enter Compatible or Enhanced Mode. Enhanced Mode requires TEST to be HIGH on the rising edge of RES and LOW four clocks later. Any other combination will place the M80C186 in Compatible Mode. A weak internal pullup insures a HIGH state when the pin is not driven.</p> <p>TEST—In Compatible Mode this pin is configured to operate as TEST. This pin is examined by the WAIT instruction. If the TEST input is HIGH when WAIT execution begins, instruction execution will suspend. TEST will be resampled every five clocks until it goes LOW, at which time execution will resume. If interrupts are enabled while the M80C186 is waiting for TEST, interrupts will be serviced.</p> <p>BUSY—In Enhanced Mode, this pin is configured to operate as BUSY. The BUSY input is used to notify the M80C186 of Numerics Processor Extension activity. Floating point instructions executing in the M80C186 sample the BUSY pin to determine when the Numerics Processor is ready to accept a new command. BUSY is active HIGH.</p>

Table 1. M80C186 Pin Description (Continued)

Symbol	PGA	QFP	Type	Name and Function						
TMR IN 0, TMR IN 1	20 21	58 57	I I	Timer Inputs are used either as clock or control signals, depending upon the programmed timer mode. These inputs are active HIGH (or LOW-to-HIGH transitions are counted) and internally synchronized.						
TMR OUT 0, TMR OUT 1	22 23	56 55	O O	Timer outputs are used to provide single pulse or continuous waveform generation, depending upon the timer mode selected.						
DRQ0 DRQ1	18 19	60 59	I I	DMA Request is driven HIGH by an external device when it desires that a DMA channel (Channel 0 or 1) perform a transfer. These signals are active HIGH, level-triggered, and internally synchronized.						
NMI	46	32	I	Non-Maskable Interrupt is an edge-triggered input which causes a type 2 interrupt. NMI is not maskable internally. A transition from a LOW to HIGH initiates the interrupt at the next instruction boundary. NMI is latched internally. An NMI duration of one clock or more will guarantee service. This input is internally synchronized.						
INT0, INT1 INT2/INTA0 INT3/INTA1	45, 44 42 41	33, 34 36 37	I I/O I/O	Maskable Interrupt Requests can be requested by activating one of these pins. When configured as inputs, these pins are active HIGH. Interrupt Requests are synchronized internally. INT2 and INT3 may be configured via software to provide active-LOW interrupt-acknowledge output signals. All interrupt inputs may be configured via software to be either edge- or level-triggered. To ensure recognition, all interrupt requests must remain active until the interrupt is acknowledged. When slave mode is selected, the function of these pins changes (see Interrupt Controller section of this data sheet).						
A19/S6, A18/S5, A17/S4, A16/S3	65 66 67 68	13 12 11 10	O O O O	Address Bus Outputs (16–19) and Bus Cycle Status (3–6) reflect the four most significant address bits during T ₁ . These signals are active HIGH. During T ₂ , T ₃ , T _W , and T ₄ , status information is available on these lines as encoded below:						
				<table border="1"> <thead> <tr> <th></th> <th>Low</th> <th>High</th> </tr> </thead> <tbody> <tr> <td>S6</td> <td>Processor Cycle</td> <td>DMA Cycle</td> </tr> </tbody> </table>		Low	High	S6	Processor Cycle	DMA Cycle
	Low	High								
S6	Processor Cycle	DMA Cycle								
				S3, S4, and S5 are defined as LOW during T ₂ –T ₄ .						
AD15 AD14 AD13 AD12 AD11 AD10 AD9 AD8 AD7 AD6 AD5 AD4 AD3 AD2 AD1 AD0	1 3 5 7 10 12 14 16 2 4 6 8 11 13 15 17	9 7 5 3 68 66 64 62 8 6 4 2 67 65 63 61	I/O	Address/Data Bus (0–15) signals constitute the time multiplexed memory or I/O address (T ₁) and data (T ₂ , T ₃ , T _W , and T ₄) bus. The bus is active HIGH. A ₀ is analogous to $\overline{\text{BHE}}$ for the lower byte of the data bus, pins D ₇ through D ₀ . It is LOW during T ₁ when a byte is to be transferred onto the lower portion of the bus in memory or I/O operations.						

Table 1. M80C186 Pin Description (Continued)

Symbol	PGA	QFP	Type	Name and Function		
BHE	64	14	O	The BHE (Bus High Enable) signal is analogous to A0 in that it is used to enable data on to the most significant half of the data bus, pins D15–D8. BHE will be LOW during T ₁ when the upper byte is transferred and will remain LOW through T ₃ AND T _W . BHE does not need to be latched. BHE will float during HOLD. In Enhanced Mode, BHE will also be used to signify DRAM refresh cycles. A refresh cycle is indicated by BHE and A0 being HIGH.		
				BHE and A0 Encodings		
				BHE Value	A0 Value	Function
				0	0	Word Transfer
0	1	Byte Transfer on upper half of data bus (D15–D8)				
1	0	Byte Transfer on lower half of data bus (D7–D0)				
1	1	Refresh				
ALE/QS0	61	17	O	Address Latch Enable/Queue Status 0 is provided by the M80C186 to latch the address. ALE is active HIGH. Addresses are guaranteed to be valid on the trailing edge of ALE. The ALE rising edge is generated off the rising edge of the CLKOUT immediately preceding T ₁ of the associated bus cycle, effectively one-half clock cycle earlier than in the standard M8086. The trailing edge is generated off the CLKOUT rising edge in T ₁ as in the M8086. Note that ALE is never floated.		
WR/QS1	63	15	O	Write Strobe/Queue Status 1 indicates that the data on the bus is to be written into a memory or an I/O device. WR is active for T ₂ , T ₃ , and T _W of any write cycle. It is active LOW, and floats during “HOLD.” It is driven HIGH for one clock during Reset, and then floated. When the M80C186 is in queue status mode, the ALE/QS0 and WR/QS1 pins provide information about processor/instruction queue interaction.		
				QS1	QS0	Queue Operation
				0	0	No queue operation
				0	1	First opcode byte fetched from the queue
1	1	Subsequent byte fetched from the queue				
1	0	Empty the queue				
RD/QSMD	62	16	O	Read Strobe indicates that the M80C186 is performing a memory or I/O read cycle. RD is active LOW for T ₂ , T ₃ , and T _W of any read cycle. It is guaranteed not to go LOW in T ₂ until after the Address Bus is floated. RD is active LOW, and floats during “HOLD”. RD is driven HIGH for one clock during Reset, and then the output driver is floated. A weak internal pull-up mechanism of the RD line holds it HIGH when the line is not driven. During RESET the pin is sampled to determine whether the M80C186 should provide ALE, WR and RD, or if the Queue-Status should be provided. RD should be connected to GND to provide Queue-Status data.		

Table 1. M80C186 Pin Description (Continued)

Symbol	PGA	QFP	Type	Name and Function																																								
ARDY	55	23	I	Asynchronous Ready informs the M80C186 that the addressed memory space or I/O device will complete a data transfer. The ARDY input pin will accept an asynchronous input, and is active HIGH. Only the rising edge is internally synchronized by the M80C186. This means that the falling edge of ARDY must be synchronized to the M80C186 clock. If connected to V_{CC} , no WAIT states are inserted. Asynchronous ready (ARDY) or synchronous ready (SRDY) must be active to terminate a bus cycle. If unused, this line should be tied LOW to yield control to the SRDY pin.																																								
SRDY	49	29	I	Synchronous Ready must be synchronized externally to the M80C186. The use of SRDY provides a relaxed system-timing specification on the Ready input. This is accomplished by eliminating the one-half clock cycle which is required for internally resolving the signal level when using the ARDY input. This line is active HIGH. If this line is connected to V_{CC} , no WAIT states are inserted. Asynchronous ready (ARDY) or synchronous ready (SRDY) must be active before a bus cycle is terminated. If unused, this line should be tied LOW to yield control to the ARDY pin.																																								
$\overline{\text{LOCK}}$	48	30	O	$\overline{\text{LOCK}}$ output indicates that other system bus masters are not to gain control of the system bus while $\overline{\text{LOCK}}$ is active LOW. The $\overline{\text{LOCK}}$ signal is requested by the LOCK prefix instruction and is activated at the beginning of the first data cycle associated with the instruction following the LOCK prefix. It remains active until the completion of the instruction following the LOCK prefix. No prefetches will occur while $\overline{\text{LOCK}}$ is asserted. $\overline{\text{LOCK}}$ is active LOW, is driven HIGH for one clock during RESET, and then floated.																																								
$\overline{\text{S0}}, \overline{\text{S1}}, \overline{\text{S2}}$	52, 53, 54	26, 25, 24	O	<p>Bus cycle status $\overline{\text{S0}}-\overline{\text{S2}}$ are encoded to provide bus-transaction information:</p> <table border="1"> <thead> <tr> <th colspan="4">M80C186 Bus Cycle Status Information</th> </tr> <tr> <th>$\overline{\text{S2}}$</th> <th>$\overline{\text{S1}}$</th> <th>$\overline{\text{S0}}$</th> <th>Bus Cycle Initiated</th> </tr> </thead> <tbody> <tr> <td>0</td> <td>0</td> <td>0</td> <td>Interrupt Acknowledge</td> </tr> <tr> <td>0</td> <td>0</td> <td>1</td> <td>Read I/O</td> </tr> <tr> <td>0</td> <td>1</td> <td>0</td> <td>Write I/O</td> </tr> <tr> <td>0</td> <td>1</td> <td>1</td> <td>Halt</td> </tr> <tr> <td>1</td> <td>0</td> <td>0</td> <td>Instruction Fetch</td> </tr> <tr> <td>1</td> <td>0</td> <td>1</td> <td>Read Data from Memory</td> </tr> <tr> <td>1</td> <td>1</td> <td>0</td> <td>Write Data to Memory</td> </tr> <tr> <td>1</td> <td>1</td> <td>1</td> <td>Passive (no bus cycle)</td> </tr> </tbody> </table> <p>The status pins float during HOLD/HLDA. $\overline{\text{S2}}$ may be used as a logical M/I$\overline{\text{O}}$ indicator, and $\overline{\text{S1}}$ as a DT/$\overline{\text{R}}$ indicator. The status lines are driven HIGH for one clock during Reset, and then floated until a bus cycle begins.</p>	M80C186 Bus Cycle Status Information				$\overline{\text{S2}}$	$\overline{\text{S1}}$	$\overline{\text{S0}}$	Bus Cycle Initiated	0	0	0	Interrupt Acknowledge	0	0	1	Read I/O	0	1	0	Write I/O	0	1	1	Halt	1	0	0	Instruction Fetch	1	0	1	Read Data from Memory	1	1	0	Write Data to Memory	1	1	1	Passive (no bus cycle)
M80C186 Bus Cycle Status Information																																												
$\overline{\text{S2}}$	$\overline{\text{S1}}$	$\overline{\text{S0}}$	Bus Cycle Initiated																																									
0	0	0	Interrupt Acknowledge																																									
0	0	1	Read I/O																																									
0	1	0	Write I/O																																									
0	1	1	Halt																																									
1	0	0	Instruction Fetch																																									
1	0	1	Read Data from Memory																																									
1	1	0	Write Data to Memory																																									
1	1	1	Passive (no bus cycle)																																									

Table 1. M80C186 Pin Description (Continued)

Symbol	PGA	QFP	Type	Name and Function
HOLD (input) HLDA (output)	50 51	28 27	I O	<p>HOLD indicates that another bus master is requesting the local bus. The HOLD input is active HIGH. HOLD may be asynchronous with respect to the M80C186 clock. The M80C186 will issue a HLDA (HIGH) in response to a HOLD request at the end of T_4 or T_i. Simultaneous with the issuance of HLDA, the M80C186 will float the local bus and control lines. After HOLD is detected as being LOW, the M80C186 will lower HLDA. When the M80C186 needs to run another bus cycle, it will again drive the local bus and control lines.</p> <p>In Enhanced Mode, HLDA will go low when a DRAM refresh cycle is pending in the M80C186 and an external bus master has control of the bus. It will be up to the external master to relinquish the bus by lowering HOLD so that the M80C186 may execute the refresh cycle. Lowering HOLD for four clocks and returning HIGH will insure only one refresh cycle to the external master. HLDA will immediately go active after the refresh cycle has taken place.</p>
\overline{UCS}	34	44	O	<p>Upper Memory Chip Select is an active LOW output whenever a memory reference is made to the defined upper portion (1K–256K block) of memory. This line is not floated during bus HOLD. The address range activating \overline{UCS} is software programmable.</p> <p>\overline{UCS} and \overline{LCS} are sampled upon the rising edge of \overline{RES}. If both pins are held low, the M80C186 will enter ONCE Mode. In ONCE Mode all pins assume a high impedance state and remain so until a subsequent RESET. \overline{UCS} has a weak internal pullup for normal operation.</p>
\overline{LCS}	33	45	O	<p>Lower Memory Chip Select is active LOW whenever a memory reference is made to the defined lower portion (1K–256K) of memory. This line is not floated during bus HOLD. The address range activating \overline{LCS} is software programmable.</p> <p>\overline{UCS} and \overline{LCS} are sampled upon the rising edge of \overline{RES}. If both pins are held low, the M80C186 will enter ONCE Mode. In ONCE Mode all pins assume a high impedance state and remain so until a subsequent RESET. \overline{UCS} has a weak internal pullup for normal operation.</p>
$\overline{MCS0}/\overline{PEREQ}$ $\overline{MCS1}/\overline{ERROR}$ $\overline{MCS2}$ $\overline{MCS3}/\overline{NPS}$	38 37 36 35	40 41 42 43	I/O I/O O O	<p>Mid-Range Memory Chip Select signals are active LOW when a memory reference is made to the defined mid-range portion of memory (8K–512K). These lines are not floated during bus HOLD. The address ranges activating $\overline{MCS0}$–3 are software programmable.</p> <p>In Enhanced Mode, $\overline{MCS0}$ becomes a PEREQ input (Processor Extension Request). When connected to the Numerics Processor Extension, this input is used to signal the M80C186 when to make numeric data transfers to and from the NPX. $\overline{MCS3}$ becomes NPS (Numeric Processor Select) which may only be activated by communication to the Numerics Processor Extension. $\overline{MCS1}$ becomes ERROR in enhanced mode and is used to signal numerics coprocessor errors.</p>

Table 1. M80C186 Pin Description (Continued)

Symbol	PGA	QFP	Type	Name and Function
$\overline{\text{PCS}}_0$	25	53	O	Peripheral Chip Select signals 0–4 are active LOW when a reference is made to the defined peripheral area (64K byte I/O space). These lines are not floated during bus HOLD. The address ranges activating $\overline{\text{PCS}}_0$ –4 are software programmable.
$\overline{\text{PCS}}_1$ –4	27, 28, 29, 30	51, 50, 49, 48	O	
$\overline{\text{PCS}}_5/\text{A1}$	31	47	O	Peripheral Chip Select 5 or Latched A1 may be programmed to provide a sixth peripheral chip select, or to provide an internally latched A1 signal. The address range activating $\overline{\text{PCS}}_5$ is software programmable. When programmed to provide latched A1, rather than $\overline{\text{PCS}}_5$, this pin will retain the previously latched value of A1 during a bus HOLD. A1 is active HIGH.
$\overline{\text{PCS}}_6/\text{A2}$	32	46	O	Peripheral Chip Select 6 or Latched A2 may be programmed to provide a seventh peripheral chip select, or to provide an internally latched A2 signal. The address range activating $\overline{\text{PCS}}_6$ is software programmable. When programmed to provide latched A2, rather than $\overline{\text{PCS}}_6$, this pin will retain the previously latched value of A2 during a bus HOLD. A2 is active HIGH.
$\text{DT}/\overline{\text{R}}$	40	38	O	Data Transmit/Receive controls the direction of data flow through the external M8286/M8287 data bus transceiver. When LOW, data is transferred to the M80C186. When HIGH the M80C186 places write data on the data bus.
$\overline{\text{DEN}}$	39	39	O	Data Enable is provided as an M8286/M8287 data bus transceiver output enable. $\overline{\text{DEN}}$ is active LOW during each memory and I/O access. $\overline{\text{DEN}}$ is HIGH whenever $\text{DT}/\overline{\text{R}}$ changes state.



FUNCTIONAL DESCRIPTION

Introduction

The following Functional Description describes the base architecture of the M80C186. This architecture is common to the M8086, M8088, M80186 and M80286 microprocessor families as well. The M80C186 is a very high integration 16-bit microprocessor. It combines 15–20 of the most common microprocessor system components onto one chip. The M80C186 is object code compatible with the M8086/M8088 microprocessors and adds 10 new instruction types to the existing M8086/M8088 instruction set.

The M80C186 has two major modes of operation, Compatible and Enhanced. In Compatible Mode the M80C186 is completely compatible with NMOS M80186, with the exception of M8087 support. All pin functions, timings, and drive capabilities are identical. The Enhanced mode adds three new features to the system design. These are Power-Save control, Dynamic RAM refresh, and an asynchronous Numerics Co-processor interface.

M80C186 BASE ARCHITECTURE

The M8086, M8088, M80186, and M80286 family all contain the same basic set of registers, instructions, and addressing modes. The M80C186 processor is upward compatible with the M8086, M8088, and M80286 CPUs.

Register Set

The M80C186 base architecture has fourteen registers as shown in Figures 3a and 3b. These registers are grouped into the following categories.

General Registers

Eight 16-bit general purpose registers may be used to contain arithmetic and logical operands. Four of

these (AX, BX, CX, and DX) can be used as 16-bit registers or split into pairs of separate 8-bit registers.

Segment Registers

Four 16-bit special purpose registers select, at any given time, the segments of memory that are immediately addressable for code, stack, and data. (For usage, refer to Memory Organization.)

Base and Index Registers

Four of the general purpose registers may also be used to determine offset addresses of operands in memory. These registers may contain base addresses or indexes to particular locations within a segment. The addressing mode selects the specific registers for operand and address calculations.

Status and Control Registers

Two 16-bit special purpose registers record or alter certain aspects of the M80C186 processor state. These are the Instruction Pointer Register, which contains the offset address of the next sequential instruction to be executed, and the Status Word Register, which contains status and control flag bits (see Figures 3a and 3b).

Status Word Description

The Status Word records specific characteristics of the result of logical and arithmetic instructions (bits 0, 2, 4, 6, 7, and 11) and controls the operation of the M80C186 within a given operating mode (bits 8, 9, and 10). The Status Word Register is 16-bits wide. The function of the Status Word bits is shown in Table 2.

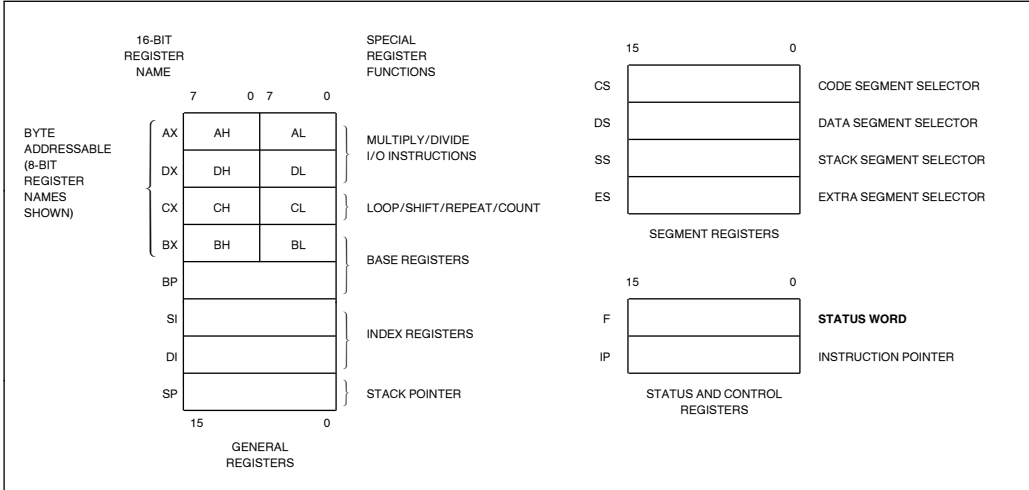

Figure 3a. M80C186 Register Set

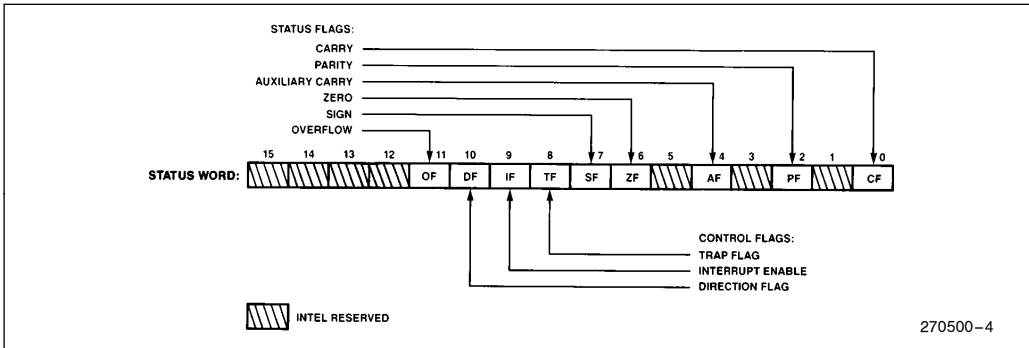

Figure 3b. Status Word Format

Table 2. Status Word Bit Functions

Bit Position	Name	Function
0	CF	Carry Flag—Set on high-order bit carry or borrow; cleared otherwise
2	PF	Parity Flag—Set if low-order 8 bits of result contain an even number of 1-bits; cleared otherwise
4	AF	Set on carry from or borrow to the low order four bits of AL; cleared otherwise
6	ZF	Zero Flag—Set if result is zero; cleared otherwise
7	SF	Sign Flag—Set equal to high-order bit of result (0 if positive, 1 if negative)
8	TF	Single Step Flag—Once set, a single step interrupt occurs after the next instruction executes. TF is cleared by the single step interrupt.
9	IF	Interrupt-enable Flag—When set, maskable interrupts will cause the CPU to transfer control to an interrupt vector specified location.
10	DF	Direction Flag—Causes string instructions to auto decrement the appropriate index register when set. Clearing DF causes auto increment.
11	OF	Overflow Flag—Set if the signed result cannot be expressed within the number of bits in the destination operand; cleared otherwise

Instruction Set

The instruction set is divided into seven categories: data transfer, arithmetic, shift/rotate/logical, string manipulation, control transfer, high-level instructions, and processor control. These categories are summarized in Figure 4.

An M80C186 instruction can reference anywhere from zero to several operands. An operand can reside in a register, in the instruction itself, or in memory. Specific operand addressing modes are discussed later in this data sheet.

Memory Organization

Memory is organized in sets of segments. Each segment is a linear contiguous sequence of up to 64K (2^{16}) 8-bit bytes. Memory is addressed using a two-component address (a pointer) that consists of a 16-bit base segment and a 16-bit offset. The 16-bit base values are contained in one of four internal segment register (code, data, stack, extra). The physical address is calculated by shifting the base value LEFT by four bits and adding the 16-bit offset value to yield a 20-bit physical address (see Figure 5). This allows for a 1 MByte physical address size.

All instructions that address operands in memory must specify the base segment and the 16-bit offset value. For speed and compact instruction encoding, the segment register used for physical address generation is implied by the addressing mode used (see Table 3). These rules follow the way programs are written (see Figure 6) as independent modules that require areas for code and data, a stack, and access to external data areas.

Special segment override instruction prefixes allow the implicit segment register selection rules to be overridden for special cases. The stack, data, and extra segments may coincide for simple programs.

GENERAL PURPOSE	
MOV	Move byte or word
PUSH	Push word onto stack
POP	Pop word off stack
PUSHA	Push all registers on stack
POPA	Pop all registers from stack
XCHG	Exchange byte or word
XLAT	Translate byte
INPUT/OUTPUT	
IN	Input byte or word
OUT	Output byte or word
ADDRESS OBJECT	
LEA	Load effective address
LDS	Load pointer using DS
LES	Load pointer using ES
FLAG TRANSFER	
LAHF	Load AH register from flags
SAHF	Store AH register in flags
PUSHF	Push flags onto stack
POPF	Pop flags off stack
ADDITION	
ADD	Add byte or word
ADC	Add byte or word with carry
INC	Increment byte or word by 1
AAA	ASCII adjust for addition
DAA	Decimal adjust for addition
SUBTRACTION	
SUB	Subtract byte or word
SBB	Subtract byte or word with borrow
DEC	Decrement byte or word by 1
NEG	Negate byte or word
CMP	Compare byte or word
AAS	ASCII adjust for subtraction
DAS	Decimal adjust for subtraction
MULTIPLICATION	
MUL	Multiply byte or word unsigned
IMUL	Integer multiply byte or word
AAM	ASCII adjust for multiply
DIVISION	
DIV	Divide byte or word unsigned
IDIV	Integer divide byte or word
AAD	ASCII adjust for division
CBW	Convert byte to word
CWD	Convert word to doubleword
MOVS	Move byte or word string
INS	Input bytes or word string
OUTS	Output bytes or word string
CMPS	Compare byte or word string
SCAS	Scan byte or word string
LODS	Load byte or word string
STOS	Store byte or word string
REP	Repeat
REPE/REPZ	Repeat while equal/zero
REPNE/REPNZ	Repeat while not equal/not zero
LOGICALS	
NOT	"Not" byte or word
AND	"And" byte or word
OR	"Inclusive or" byte or word
XOR	"Exclusive or" byte or word
TEST	"Test" byte or word
SHIFTS	
SHL/SAL	Shift logical/arithmetic left byte or word
SHR	Shift logical right byte or word
SAR	Shift arithmetic right byte or word
ROTATES	
ROL	Rotate left byte or word
ROR	Rotate right byte or word
RCL	Rotate through carry left byte or word
RCR	Rotate through carry right byte or word
FLAG OPERATIONS	
STC	Set carry flag
CLC	Clear carry flag
CMC	Complement carry flag
STD	Set direction flag
CLD	Clear direction flag
STI	Set interrupt enable flag
CLI	Clear interrupt enable flag
EXTERNAL SYNCHRONIZATION	
HLT	Halt until interrupt or reset
WAIT	Wait for $\overline{\text{TEST}}$ pin active
ESC	Escape to extension processor
LOCK	Lock bus during next instruction
NO OPERATION	
NOP	No operation
HIGH LEVEL INSTRUCTIONS	
ENTER	Format stack for procedure entry
LEAVE	Restore stack for procedure exit
BOUND	Detects values outside prescribed range

Figure 4. M80C186 Instruction Set

CONDITIONAL TRANSFERS			
JA/JNBE	Jump if above/not below nor equal	JO	Jump if overflow
JAE/JNB	Jump if above or equal/not below	JP/JPE	Jump if parity/parity even
JB/JNAE	Jump if below/not above nor equal	JS	Jump if sign
JBE/JNA	Jump if below or equal/not above	UNCONDITIONAL TRANSFERS	
JC	Jump if carry	CALL	Call procedure
JE/JZ	Jump if equal/zero	RET	Return from procedure
JG/JNLE	Jump if greater/not less nor equal	JMP	Jump
JGE/JNL	Jump if greater or equal/not less	ITERATION CONTROLS	
JL/JNGE	Jump if less/not greater nor equal	LOOP	Loop
JLE/JNG	Jump if less or equal/not greater	LOOPE/LOOPZ	Loop if equal/zero
JNC	Jump if not carry	LOOPNE/LOOPNZ	Loop if not equal/not zero
JNE/JNZ	Jump if not equal/not zero	JCXZ	Jump if register CX = 0
JNO	Jump if not overflow	INTERRUPTS	
JNP/JPO	Jump if not parity/parity odd	INT	Interrupt
JNS	Jump if not sign	INTO	Interrupt if overflow
		IRET	Interrupt return

Figure 4. M80C186 Instruction Set (Continued)

To access operands that do not reside in one of the four immediately available segments, a full 32-bit pointer can be used to reload both the base (segment) and offset values.

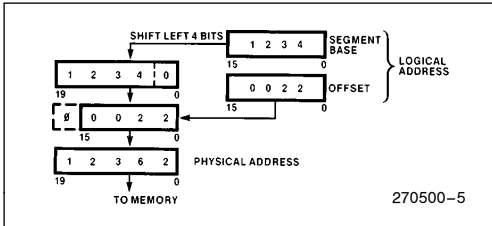

Figure 5. Two Component Address

Table 3. Segment Register Selection Rules

Memory Reference Needed	Segment Register Used	Implicit Segment Selection Rule
Instructions	Code (CS)	Instruction prefetch and immediate data.
Stack	Stack (SS)	All stack pushes and pops; any memory references which use BP Register as a base register.
External Data (Global)	Extra (ES)	All string instruction references which use the DI register as an index.
Local Data	Data (DS)	All other data references.

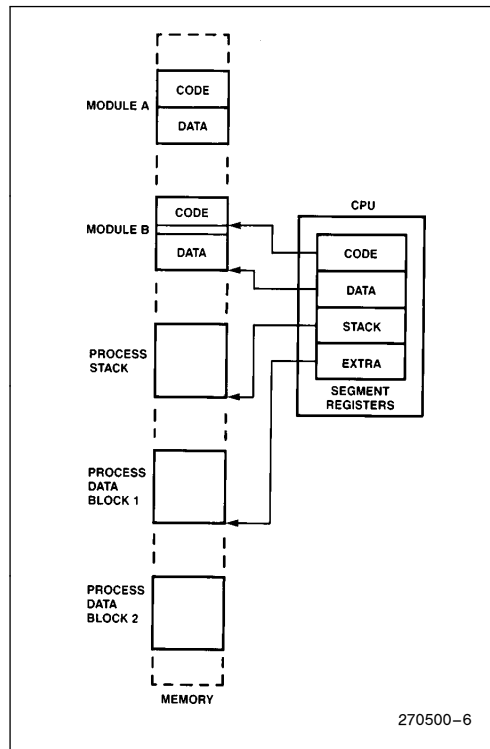

Figure 6. Segmented Memory Helps Structure Software

Addressing Modes

The M80C186 provides eight categories of addressing modes to specify operands. Two addressing modes are provided for instructions that operate on register or immediate operands:

- *Register Operand Mode:* The operand is located in one of the 8- or 16-bit general registers.
- *Immediate Operand Mode:* The operand is included in the instruction.

Six modes are provided to specify the location of an operand in a memory segment. A memory operand address consists of two 16-bit components: a segment base and an offset. The segment base is supplied by a 16-bit segment register either implicitly chosen by the addressing mode or explicitly chosen by a segment override prefix. The offset, also called the effective address, is calculated by summing any combination of the following three address elements:

- the *displacement* (an 8- or 16-bit immediate value contained in the instruction);
- the *base* (contents of either the BX or BP base registers); and
- the *index* (contents of either the SI or DI index registers).

Any carry out from the 16-bit addition is ignored. Eight-bit displacements are sign extended to 16-bit values.

Combinations of these three address elements define the six memory addressing modes, described below.

- *Direct Mode:* The operand's offset is contained in the instruction as an 8- or 16-bit displacement element.
- *Register Indirect Mode:* The operand's offset is in one of the registers SI, DI, BX, or BP.
- *Based Mode:* The operand's offset is the sum of an 8- or 16-bit displacement and the contents of a base register (BX or BP).
- *Indexed Mode:* The operand's offset is the sum of an 8- or 16-bit displacement and the contents of an index register (SI or DI).
- *Based Indexed Mode:* The operand's offset is the sum of the contents of a base register and an Index register.
- *Based indexed Mode with Displacement:* The operand's offset is the sum of a base register's contents, an index register's contents, and an 8- or 16-bit displacement.

Data Types

The M80C186 directly supports the following data types:

- *Integer:* A signed binary numeric value contained in an 8-bit byte or a 16-bit word. All operations assume a 2's complement representation. Signed 32- and 64-bit integers are supported using a Numeric Data Coprocessor with the M80C186.
- *Ordinal:* An unsigned binary numeric value contained in an 8-bit byte or a 16-bit word.
- *Pointer:* A 16- or 32-bit quantity, composed of a 16-bit offset component or a 16-bit segment base component in addition to a 16-bit offset component.
- *String:* A contiguous sequence of bytes or words. A string may contain from 1 to 64K bytes.
- *ASCII:* A byte representation of alphanumeric and control characters using the ASCII standard of character representation.
- *BCD:* A byte (unpacked) representation of the decimal digits 0–9.
- *Packed BCD:* A byte (packed) representation of two decimal digits (0–9). One digit is stored in each nibble (4-bits) of the byte.
- *Floating Point:* A signed 32-, 64-, or 80-bit real number representation. (Floating point operands are supported using a Numeric Data Coprocessor with the M80C186.)

In general, individual data elements must fit within defined segment limits. Figure 7 graphically represents the data types supported by the M80C186.

I/O Space

The I/O space consists of 64K 8-bit or 32K 16-bit ports. Separate instructions address the I/O space with either an 8-bit port address, specified in the instruction, or a 16-bit port address in the DX register. 8-bit port addresses are zero extended such that A₁₅–A₈ are LOW. I/O port addresses 00F8(H) through 00FF(H) are reserved.

Interrupts

An interrupt transfers execution to a new program location. The old program address (CS:IP) and machine state (Status Word) are saved on the stack to allow resumption of the interrupted program. Interrupts fall into three classes: hardware initiated, INT instructions, and instruction exceptions. Hardware initiated interrupts occur in response to an external input and are classified as non-maskable or maskable.

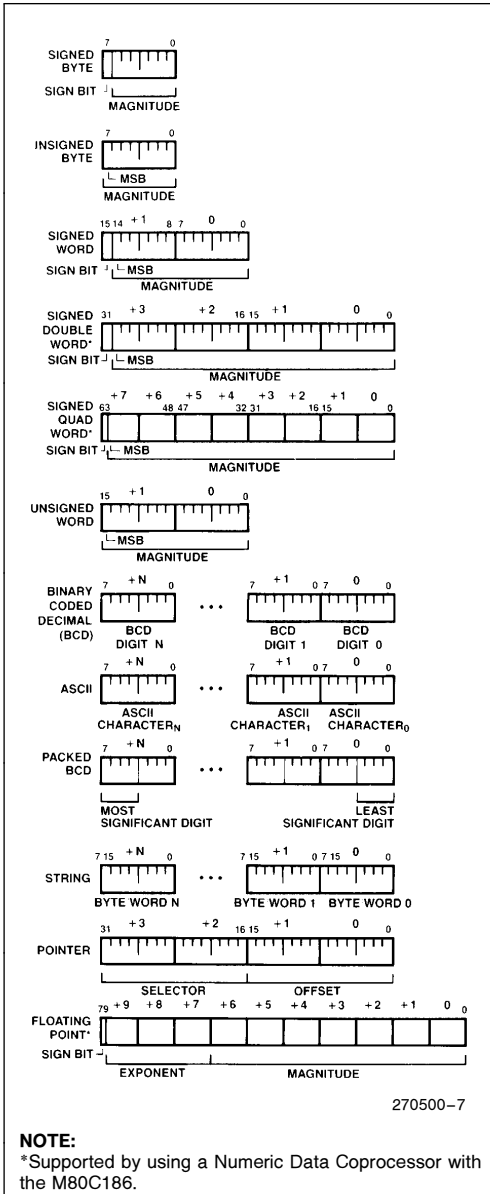

Figure 7. M80C186 Supported Data Types

Programs may cause an interrupt with an INT instruction. Instruction exceptions occur when an unusual condition, which prevents further instruction processing, is detected while attempting to execute an instruction. If the exception was caused by executing an ESC instruction with the ESC trap bit set in the relocation register, the return instruction will point to the ESC instruction, or to the segment override prefix immediately preceding the ESC instruc-

tion if the prefix was present. In all other cases, the return address from an exception will point at the instruction immediately following the instruction causing the exception.

A table containing up to 256 pointers defines the proper interrupt service routine for each interrupt. Interrupts 0–31, some of which are used for instruction exceptions, are reserved. Table 4 shows the M80C186 predefined types and default priority levels. For each interrupt, an 8-bit vector must be supplied to the M80C186 which identifies the appropriate table entry. Exceptions supply the interrupt vector internally. In addition, internal peripherals and noncascaded external interrupts will generate their own vectors through the internal interrupt controller. INT instructions contain or imply the vector and allow access to all 256 interrupts. Maskable hardware initiated interrupts supply the 8-bit vector to the CPU during an interrupt acknowledge bus sequence. Non-maskable hardware interrupts use a predefined internally supplied vector.

Interrupt Sources

The M80C186 can service interrupts generated by software or hardware. The software interrupts are generated by specific instructions (INT, ESC, unused OP, etc.) or the results of conditions specified by instructions (array bounds check, INTO, DIV, IDIV, etc.). All interrupt sources are serviced by an indirect call through an element of a vector table. This vector table is indexed by using the interrupt vector type (Table 4), multiplied by four. All hardware-generated interrupts are sampled at the end of each instruction. Thus, the software interrupts will begin service first. Once the service routine is entered and interrupts are enabled, any hardware source of sufficient priority can interrupt the service routine in progress.

The software generated M80C186 interrupts are described below.

DIVIDE ERROR EXCEPTION (TYPE 0)

Generated when a DIV or IDIV instruction quotient cannot be expressed in the number of bits in the destination.

SINGLE-STEP INTERRUPT (TYPE 1)

Generated after most instructions if the TF flag is set. Interrupts will not be generated after prefix instructions (e.g., REP), instructions which modify segment registers (e.g., POP DS), or the WAIT instruction.

NON-MASKABLE INTERRUPT—NMI (TYPE 2)

An external interrupt source which cannot be masked.

Table 4. M80C186 Interrupt Vectors

Interrupt Name	Vector Type	Default Priority ⁽⁴⁾	Related Instructions
Divide Error Exception	0	1 ⁽¹⁾	DIV, IDIV
Single Step Interrupt	1	12 ⁽²⁾	All
NMI	2	1	All
Breakpoint Interrupt	3	1 ⁽¹⁾	INT
INT0 Detected	4	1 ⁽¹⁾	INT0
Overflow Exception			
Array Bounds Exception	5	1 ⁽¹⁾	BOUND
Unused-Opcode Exception	6	1 ⁽¹⁾	Undefined Opcodes
ESC Opcode Exception	7	1 ⁽¹⁾ , (5)	ESC Opcodes
Timer 0 Interrupt	8	2A ⁽³⁾	
Timer 1 Interrupt	18	2B ⁽³⁾	
Timer 2 Interrupt	19	2C ⁽³⁾	
Reserved	9	3	
DMA 0 Interrupt	10	4	
DMA 1 Interrupt	11	5	
INT0 Interrupt	12	6	
INT1 Interrupt	13	7	
INT2 Interrupt	14	8	
INT3 Interrupt	15	9	

NOTES:

- These are generated as the result of an instruction execution.
- This is handled as in the M8086.
- All three timers constitute one source of request to the interrupt controller. The Timer interrupts all have the same default priority level with respect to all other interrupt sources. However, they have a defined priority ordering amongst themselves. (Priority 2A is higher priority than 2B.) Each Timer interrupt has a separate vector type number.
- Default priorities for the interrupt sources are used only if the user does not program each source into a unique priority level.
- An escape opcode will cause a trap if the M80C186 is in compatible mode or if the processor is in enhanced mode with the proper bit set in the peripheral control block relocation register.

BREAKPOINT INTERRUPT (TYPE 3)

A one-byte version of the INT instruction. It uses 12 as an index into the service routine address table (because it is a type 3 interrupt).

INT0 DETECTED OVERFLOW EXCEPTION (TYPE 4)

Generated during an INT0 instruction if the OF bit is set.

ARRAY BOUNDS EXCEPTION (TYPE 5)

Generated during a BOUND instruction if the array index is outside the array bounds. The array bounds are located in memory at a location indicated by one of the instruction operands. The other operand indicates the value of the index to be checked.

UNUSED OPCODE EXCEPTION (TYPE 6)

Generated if execution is attempted on undefined opcodes.

ESCAPE OPCODE EXCEPTION (TYPE 7)

Generated if execution is attempted of ESC opcodes (D8H–DFH). In compatible mode operation, ESC opcodes will always generate this exception. In enhanced mode operation, the exception will be generated only if a bit in the relocation register is set. The return address of this exception will point to the ESC instruction causing the exception. If a segment override prefix preceded the ESC instruction, the return address will point to the segment override prefix.

Hardware-generated interrupts are divided into two groups: maskable interrupts and non-maskable interrupts. The M80C186 provides maskable hardware interrupt request pins INT0–INT3. In addition, maskable interrupts may be generated by the M80C186 integrated DMA controller and the integrated timer unit. The vector types for these interrupts is shown in Table 4. Software enables these inputs by setting the interrupt flag bit (IF) in the Status Word. The interrupt controller is discussed in the peripheral section of this data sheet.

Further maskable interrupts are disabled while servicing an interrupt because the IF bit is reset as part of the response to an interrupt or exception. The saved Status Word will reflect the enable status of the processor prior to the interrupt. The interrupt flag will remain zero unless specifically set. The interrupt return instruction restores the Status Word, thereby restoring the original status of IF bit. If the interrupt return re-enables interrupts, and another interrupt is pending, the M80C186 will immediately service the highest-priority interrupt pending, i.e., no instructions of the main line program will be executed.

Non-Maskable Interrupt Request (NMI)

A non-maskable interrupt (NMI) is also provided. This interrupt is serviced regardless of the state of the IF bit. A typical use of NMI would be to activate a power failure routine. The activation of this input causes an interrupt with an internally supplied vector value of 2. No external interrupt acknowledge sequence is performed. The IF bit is cleared at the beginning of an NMI interrupt to prevent maskable interrupts from being serviced.

Single-Step Interrupt

The M80C186 has an internal interrupt that allows programs to execute one instruction at a time. It is called the single-step interrupt and is controlled by the single-step flag bit (TF) in the Status Word. Once this bit is set, an internal single-step interrupt will occur after the next instruction has been executed. The interrupt clears the TF bit and uses an internally supplied vector of 1. The IRET instruction is used to set the TF bit and transfer control to the next instruction to be single-stepped.

Initialization and Processor Reset

Processor initialization or startup is accomplished by driving the RES input pin LOW. RES forces the M80C186 to terminate all execution and local bus activity. No instruction or bus activity will occur as long as RES is active. After RES becomes inactive and an internal processing interval elapses, the M80C186 begins execution with the instruction at physical location FFFF0(H). RES also sets some registers to predefined values as shown in Table 5.

Table 5. M80C186 Initial Register State after RESET

Status Word	F002(H)
Instruction Pointer	0000(H)
Code Segment	FFFF(H)
Data Segment	0000(H)
Extra Segment	0000(H)
Stack Segment	0000(H)
Relocation Register	20FF(H)
UMCS	FFFB(H)

M80C186 CLOCK GENERATOR

The M80C186 provides an on-chip clock generator for both internal and external clock generation. The clock generator features a crystal oscillator, a divide-by-two counter, synchronous and asynchronous ready inputs, and reset circuitry.

Oscillator

The M80C186 oscillator circuit is designed to be used with either a parallel resonant fundamental or third-overtone mode crystal, depending upon the frequency range of the application as shown in Figure 8a. This is used as the time base for the M80C186. The crystal frequency chosen should be twice the required processor frequency. Use of an LC or RC circuit is not recommended.

The oscillator output is not directly available external to the M80C186. The two recommended crys-

tal configurations are shown in Figures 8b and 8c. When used in third-overtone mode the tank circuit shown in Figure 8b is recommended for stable operation. The sum of the stray capacitances and loading capacitors should equal the values shown. It is advisable to limit stray capacitance between the X1 and X2 pins to less than 10 pF. While a fundamental-mode circuit will require approximately 1 ms for start-up, the third-overtone arrangement may require 1 ms to 3 ms to stabilize.

Alternately the oscillator pins may be driven from an external source as shown in Figure 8d or Figure 8e. The configuration shown in Figure 8f is not recommended.

The following parameters may be used for choosing a crystal:

Temperature Range:	-55°C to +125°C
ESR (Equivalent Series Resistance):	40Ω max
C ₀ (Shunt Capacitance of Crystal):	7.0 pf max
C ₁ (Load Capacitance):	20 pF ± 2 pF
Drive Level:	1 mW max

Clock Generator

The M80C186 clock generator provides the 50% duty cycle processor clock for the M80C186. It does this by dividing the oscillator output by 2 forming the symmetrical clock. If an external oscillator is used, the state of the clock generator will change on the falling edge of the oscillator signal. The CLKOUT pin provides the processor clock signal for use outside the M80C186. This may be used to drive other system components. All timings are referenced to the output clock.

READY Synchronization

The M80C186 provides both synchronous and asynchronous ready inputs. Asynchronous ready synchronization is accomplished by circuitry which samples ARDY in the middle of T₂, T₃ and again in the middle of each T_W until ARDY is sampled HIGH. One-half CLKOUT cycle of resolution time is used. Full synchronization is performed only on the rising edge of ARDY, i.e., the falling edge of ARDY must be synchronized to the CLKOUT signal if it will occur during T₂, T₃, or T_W. High-to-LOW transitions of ARDY must be performed synchronously to the CPU clock.

A second ready input (SRDY) is provided to interface with externally synchronized ready signals. This input is sampled at the end of T₂, T₃ and again at the end of each T_W until it is sampled HIGH. By using this input rather than the asynchronous ready input, the half-clock cycle resolution time penalty is eliminated.

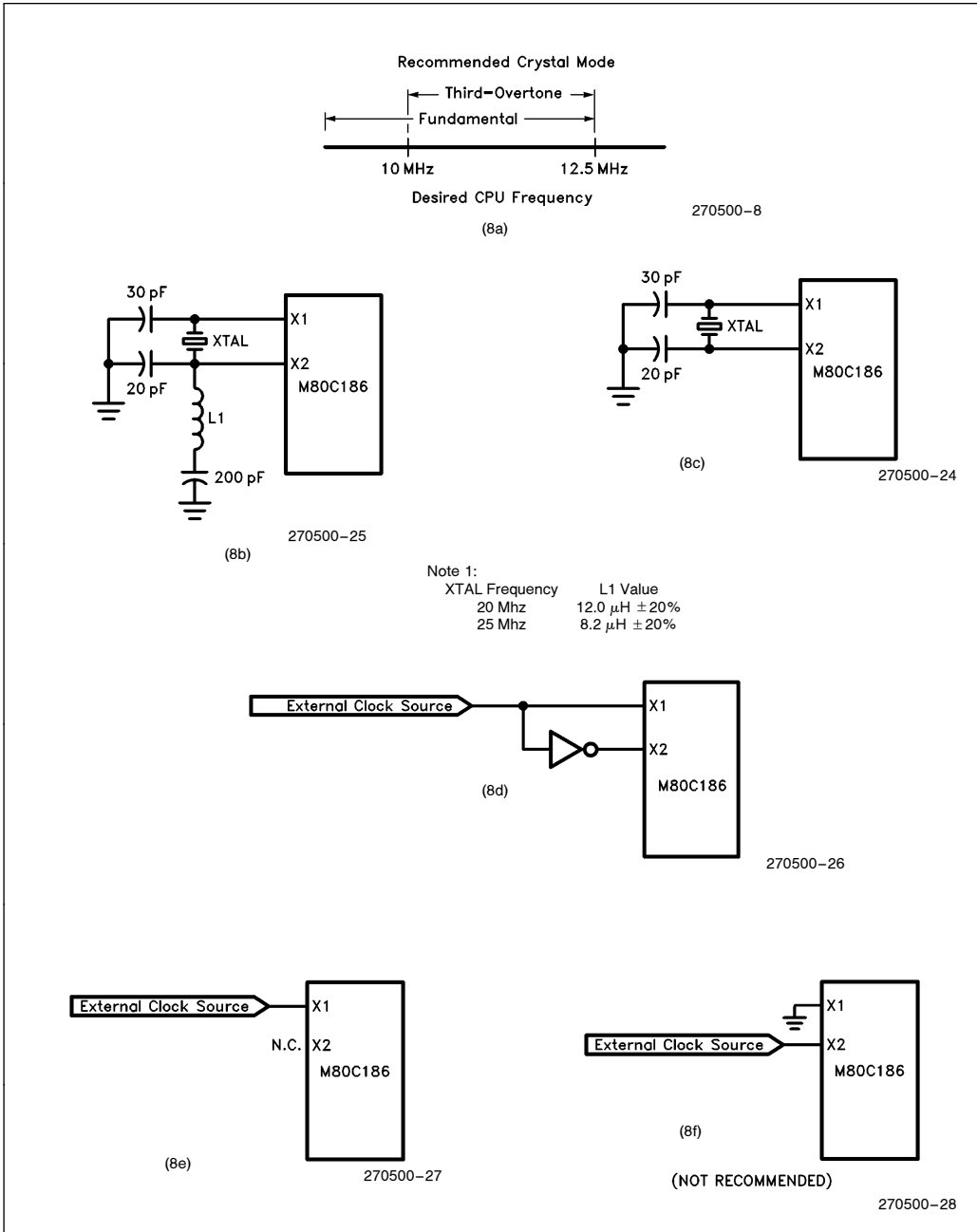

Figure 8. M80C186 Oscillator Configurations

This input must satisfy set-up and hold times to guarantee proper operation of the circuit.

In addition, the M80C186, as part of the integrated chip-select logic, has the capability to program WAIT states for memory and peripheral blocks. This is discussed in the Chip Select/Ready Logic description.

RESET Logic

The M80C186 provides both a \overline{RES} input pin and a synchronized RESET pin for use with other system components. The \overline{RES} input pin on the M80C186 is provided with hysteresis in order to facilitate power-on Reset generation via an RC network. RESET is guaranteed to remain active for at least five clocks given a \overline{RES} input of at least six clocks. RESET may be delayed up to two and one-half clocks behind RES.

Multiple M80C186 processors may be synchronized through the \overline{RES} input pin, since this input resets both the processor and divide-by-two internal counter in the clock generator. In order to insure that the divide-by-two counters all begin counting at the same time, the active going edge of \overline{RES} must satisfy a 25 ns setup time before the falling edge of the M80C186 clock input. In addition, in order to insure that all CPUs begin executing in the same clock cycle, the reset must satisfy a 15 ns setup time before the rising edge of the CLKOUT signal of all the processors.

LOCAL BUS CONTROLLER

The M80C186 provides a local bus controller to generate the local bus control signals. In addition, it employs a HOLD/HLDA protocol for relinquishing the local bus to other bus masters. It also provides control lines that can be used to enable external buffers and to direct the flow of data on and off the local bus.

Memory/Peripheral Control

The M80C186 provides ALE, \overline{RD} , and \overline{WR} bus control signals. The \overline{RD} and \overline{WR} signals are used to strobe data from memory to the M80C186 or to strobe data from the M80C186 to memory. The ALE line provides a strobe to address latches for the multiplexed address/data bus. The M80C186 local bus controller does not provide a memory/I/O signal. If this is required, the user will have to use the $\overline{S2}$ signal (which will require external latching), make the memory and I/O spaces nonoverlapping, or use only the integrated chip-select circuitry.

Transceiver Control

The M80C186 generates two control signals to be connected to external transceiver chips. This capability allows the addition of transceivers for extra buffering without adding external logic. These control lines, DT/ \overline{R} and \overline{DEN} , are generated to control the flow of data through the transceivers. The operation of these signals is shown in Table 6.

Table 6. Transceiver Control Signals Description

Pin Name	Function
\overline{DEN} (Data Enable)	Enables the output drivers of the transceivers. It is active LOW during memory, I/O, or INTA cycles.
DT/ \overline{R} (Data Transmit/Receive)	Determines the direction of travel through the transceivers. A HIGH level directs data away from the processor during write operations, while a LOW level directs data toward the processor during a read operation.

Local Bus Arbitration

The M80C186 uses a HOLD/HLDA system of local bus exchange. This provides an asynchronous bus exchange mechanism. This means multiple masters utilizing the same bus can operate at separate clock frequencies. The M80C186 provides a single HOLD/HLDA pair through which all other bus masters may gain control of the local bus. This requires external circuitry to arbitrate which external device will gain control of the bus from the M80C186 when there is more than one alternate local bus master. When the M80C186 relinquishes control of the local bus, it floats \overline{DEN} , \overline{RD} , \overline{WR} , $\overline{S0-S2}$, LOCK, AD0-AD15, A16-A19, \overline{BHE} , and DT/ \overline{R} to allow another master to drive these lines directly.

The M80C186 HOLD latency time, i.e., the time between HOLD request and HOLD acknowledge, is a function of the activity occurring in the processor when the HOLD request is received. A HOLD request is the highest-priority activity request which the processor may receive: higher than instruction fetching or internal DMA cycles. However, if a DMA cycle is in progress, the M80C186 will complete the transfer before relinquishing the bus. This implies that if a HOLD request is received just as a DMA transfer begins, the HOLD latency time can be as great as 4 bus cycles. This will occur if a DMA word transfer operation is taking place from an odd ad-

dress to an odd address. This is a total of 16 clocks or more, if WAIT states are required. In addition, if locked transfers are performed, the HOLD latency time will be increased by the length of the locked transfer.

Local Bus Controller and Reset

Upon receipt of a RESET pulse from the $\overline{\text{RES}}$ input, the local bus controller will perform the following action:

- Drive $\overline{\text{DEN}}$, $\overline{\text{RD}}$, and $\overline{\text{WR}}$ HIGH for one clock cycle, then float.

NOTE:

$\overline{\text{RD}}$ is also provided with an internal pull-up device to prevent the processor from inadvertently entering Queue Status mode during reset.

- Drive $\overline{\text{S0}}\text{--}\overline{\text{S2}}$ to the passive state (all HIGH) and then float.
- Drive $\overline{\text{LOCK}}$ HIGH and then float.
- Float AD0--15 , A16--19 , $\overline{\text{BHE}}$, $\text{DT}/\overline{\text{R}}$.
- Drive ALE LOW (ALE is never floated).
- Drive HLDA LOW.

INTERNAL PERIPHERAL INTERFACE

All the M80C186 integrated peripherals are controlled via 16-bit registers contained within an internal 256-byte control block. This control block may be mapped into either memory or I/O space. Internal logic will recognize the address and respond to the bus cycle. During bus cycles to internal registers, the bus controller will signal the operation externally (i.e., the $\overline{\text{RD}}$, $\overline{\text{WR}}$, status, address, data, etc., lines will be driven as in a normal bus cycle), but D_{15-0} , SRDY , and ARDY will be ignored. The base address of the control block must be on an even 256-byte boundary (i.e., the lower 8 bits of the base address are all zeros). All of the defined registers within this control block may be read or written by the M80C186 CPU at any time. The location of any register contained within the 256-byte control block is determined by the current base address of the control block.

The control block base address is programmed via a 16-bit relocation register contained within the control block at offset FEH from the base address of the control block (see Figure 9). It provides the upper 12 bits of the base address of the control block. The control block is effectively an internal chip select range and must abide by all the rules concerning chip selects (the chip select circuitry is discussed later in this data sheet). Any access to the 256 bytes of the control block activates an internal chip select.

Other chip selects may overlap the control block only if they are programmed to zero wait states and ignore external ready. In addition, bit 12 of this register determines whether the control block will be mapped into I/O or memory space. If this bit is 1, the control block will be located in memory space, whereas if the bit is 0, the control block will be located in I/O space. If the control register block is mapped into I/O space, the upper 4 bits of the base address must be programmed as 0 (since I/O addresses are only 16 bits wide).

In addition to providing relocation information for the control block, the relocation register contains bits which place the interrupt controller into slave mode, and cause the CPU to interrupt upon encountering ESC instructions. At RESET, the relocation register is set to 20FFH. This causes the control block to start at FF00H in I/O space. An offset map of the 256-byte control register block is shown in Figure 10.

The integrated M80C186 peripherals operate semi-autonomously from the CPU. Access to them for the most part is via software read/write of the control block. Most of these registers can be both read and written. A few dedicated lines, such as interrupts and DMA request provide real-time communication between the CPU and peripherals as in a more conventional system utilizing discrete peripheral blocks. The overall interaction and function of the peripheral blocks has not substantially changed.

CHIP-SELECT/READY GENERATION LOGIC

The M80C186 contains logic which provides programmable chip-select generation for both memories and peripherals. In addition, it can be programmed to provide READY (or WAIT state) generation. It can also provide latched address bits A1 and A2. The chip-select lines are active for all memory and I/O cycles in their programmed areas, whether they be generated by the CPU or by the integrated DMA unit.

Memory Chip Selects

The M80C186 provides 6 memory chip select outputs for 3 address areas; upper memory, lower memory, and midrange memory. One each is provided for upper memory and lower memory, while four are provided for midrange memory.

The range for each chip select is user-programmable and can be set to 2K, 4K, 8K, 16K, 32K, 64K, 128K (plus 1K and 256K for upper and lower chip selects). In addition, the beginning or base address

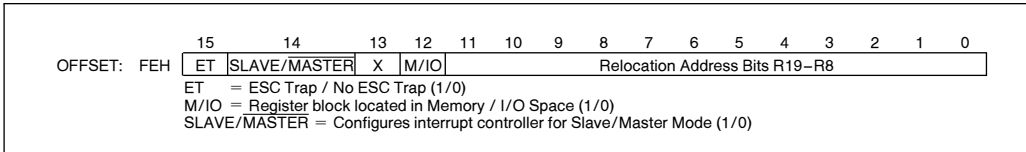

Figure 9. Relocation Register

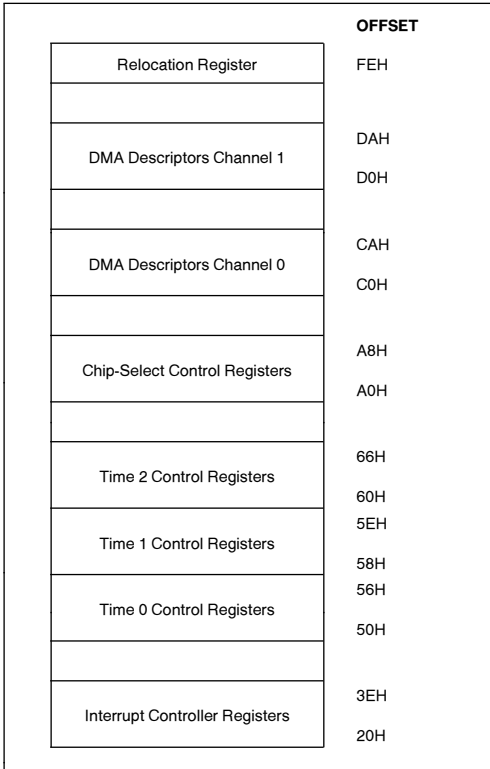

Figure 10. Internal Register Map

of the midrange memory chip select may also be selected. Only one chip select may be programmed to be active for any memory location at a time. M80C186 memory is arranged in words but chip selects are sized in bytes. If sixteen 64K x 1 memories are used then the memory block size will be 128K, not 64K.

Upper Memory \overline{CS}

The M80C186 provides a chip select, called \overline{UCS} , for the top of memory. The top of memory is usually used as the system memory because after reset the M80C186 begins executing at memory location FFFF0H.

The upper limit of memory defined by this chip select is always FFFFFH, while the lower limit is programmable. By programming the lower limit, the size of the select block is also defined. Table 7 shows the relationship between the base address selected and the size of the memory block obtained.

Table 7. UMCS Programming Values

Starting Address (Base Address)	Memory Block Size	UMCS Value (Assuming R0 = R1 = R2 = 0)
FFC00	1K	FFF8H
FF800	2K	FFB8H
FF000	4K	FF38H
FE000	8K	FE38H
FC000	16K	FC38H
F8000	32K	F838H
F0000	64K	F038H
E0000	128K	E038H
C0000	256K	C038H

The lower limit of this memory block is defined in the UMCS register (see Figure 11). This register is at offset A0H in the internal control block. The legal values for bits 6–13 and the resulting starting address and memory block sizes are given in Table 7. Any combination of bits 6–13 not shown in Table 7 will result in undefined operation. After reset, the UMCS register is programmed for a 1K area. It must be reprogrammed if a larger upper memory area is desired.

Any internally generated 20-bit address whose upper 16 bits are greater than or equal to UMCS (with bits 0–5 “0”) will cause UCS to be activated. UMCS bits R2–R0 are used to specify READY mode for the area of memory defined by this chip-select register, as explained below.

Lower Memory \overline{CS}

The M80C186 provides a chip select for low memory called \overline{LCS} . The bottom of memory contains the interrupt vector table, starting at location 00000H.



The lower limit of memory defined by this chip select is always 0H, while the upper limit is programmable. By programming the upper limit, the size of the memory block is also defined. Table 8 shows the relationship between the upper address selected and the size of the memory block obtained.

Table 8. LMCS Programming Values

Upper Address	Memory Block Size	LMCS Value (Assuming R0 = R1 = R2 = 0)
003FFH	1K	0038H
007FFH	2K	0078H
00FFFH	4K	00F8H
01FFFH	8K	01F8H
03FFFH	16K	03F8H
07FFFH	32K	07F8H
0FFFFH	64K	0FF8H
1FFFFH	128K	1FF8H
3FFFFH	256K	3FF8H

The upper limit of this memory block is defined in the LMCS register (see Figure 12). This register is at offset A2H in the internal control block. The legal values for bits 6–15 and the resulting upper address and memory block sizes are given in Table 8. Any combination of bits 6–15 not shown in Table 8 will result in undefined operation. After reset, the LMCS register value is undefined. However, the $\overline{\text{LCS}}$ chip-select line will not become active until the LMCS register is accessed.

Any internally generated 20-bit address whose upper 16 bits are less than or equal to LMCS (with bits 0–5 “1”) will cause $\overline{\text{LCS}}$ to be active. LMCS register bits R2–R0 are used to specify the READY mode for the area of memory defined by this chip-select register.

Mid-Range Memory $\overline{\text{CS}}$

The M80C186 provides four $\overline{\text{MCS}}$ lines which are active within a user-locatable memory block. This block can be located within the M80C186 1M byte memory address space exclusive of the areas defined by $\overline{\text{UCS}}$ and $\overline{\text{LCS}}$. Both the base ad-

dress and size of this memory block are programmable.

The size of the memory block defined by the mid-range select lines, as shown in Table 9, is determined by bits 8–14 of the MPCS register (see Figure 13). This register is at location A8H in the internal control block. One and only one of bits 8–14 must be set at a time. Unpredictable operation of the $\overline{\text{MCS}}$ lines will otherwise occur. Each of the four chip-select lines is active for one of the four equal contiguous divisions of the mid-range block. Thus, if the total block size is 32K, each chip select is active for 8K of memory with $\overline{\text{MCS0}}$ being active for the first range and $\overline{\text{MCS3}}$ being active for the last range.

The EX and MS in MPCS relate to peripheral functionality as described in a later section.

Table 9. MPCS Programming Values

Total Block Size	Individual Select Size	MPCS Bits 14–8
8K	2K	0000001B
16K	4K	0000010B
32K	8K	0000100B
64K	16K	0001000B
128K	32K	0010000B
256K	64K	0100000B
512K	128K	1000000B

The base address of the mid-range memory block is defined by bits 15–9 of the MMCS register (see Figure 14). This register is at offset A6H in the internal control block. These bits correspond to bits A19–A13 of the 20-bit memory address. Bits A12–A0 of the base address are always 0. The base address may be set at any integer multiple of the size of the total memory block selected. For example, if the mid-range block size is 32K (or the size of the block for which each $\overline{\text{MCS}}$ line is active is 8K), the block could be located at 10000H or 18000H, but not at 14000H, since the first few integer multiples of a 32K memory block are 0H, 8000H, 10000H, 18000H, etc. After reset, the contents of both of these registers is undefined. However, none of the $\overline{\text{MCS}}$ lines will be active until both the MMCS and MPCS registers are accessed.

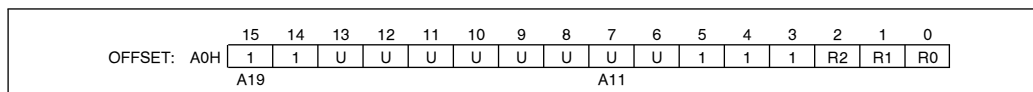

Figure 11. UMCS Register

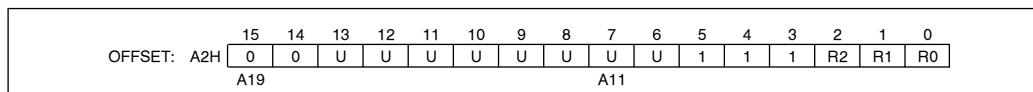

Figure 12. LMCS Register

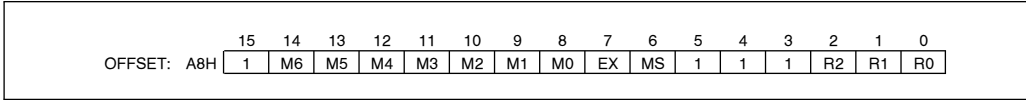

Figure 13. MPCS Register

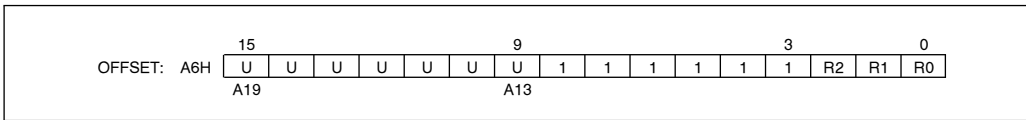

Figure 14. MMCS Register

MMCS bits R2–R0 specify READY mode of operation for all mid-range chip selects. All devices in mid-range memory must use the same number of WAIT states.

The 512K block size for the mid-range memory chip selects is a special case. When using 512K, the base address would have to be at either locations 00000H or 80000H. If it were to be programmed at 00000H when the $\overline{\text{LCS}}$ line was programmed, there would be an internal conflict between the $\overline{\text{LCS}}$ ready generation logic and the $\overline{\text{MCS}}$ ready generation logic. Likewise, if the base address were programmed at 80000H, there would be a conflict with the $\overline{\text{UCS}}$ ready generation logic. Since the $\overline{\text{LCS}}$ chip-select line does not become active until programmed, while the $\overline{\text{UCS}}$ line is active at reset, the memory base can be set only at 00000H. If this base address is selected, however, the $\overline{\text{LCS}}$ range must not be programmed.

Peripheral Chip Selects

The M80C186 can generate chip selects for up to seven peripheral devices. These chip selects are active for seven contiguous blocks of 128 bytes above a programmable base address. This base address may be located in either memory or I/O space.

Seven $\overline{\text{CS}}$ lines called $\overline{\text{PCS0}}\text{--}6$ are generated by the M80C186. The base address is user-programmable;

however it can only be a multiple of 1K bytes, i.e., the least significant 10 bits of the starting address are always 0.

$\overline{\text{PCS5}}$ and $\overline{\text{PCS6}}$ can also be programmed to provide latched address bits A1, A2. If so programmed, they cannot be used as peripheral selects. These outputs can be connected directly to the A0, A1 pins used for selecting internal registers of 8-bit peripheral chips. This scheme simplifies the hardware interface because the 8-bit registers of peripherals are simply treated as 16-bit registers located on even boundaries in I/O space or memory space where only the lower 8-bits of the register are significant: the upper 8-bits are “don’t cares.”

The starting address of the peripheral chip-select block is defined by the PACS register (see Figure 15). This register is located at offset A4H in the internal control block. Bits 15–6 of this register correspond to bits 19–10 of the 20-bit Programmable Base Address (PBA) of the peripheral chip-select block. Bits 9–0 of the PBA of the peripheral chip-select block are all zeros. If the chip-select block is located in I/O space, bits 12–15 must be programmed zero, since the I/O address is only 16 bits wide. Table 10 shows the address range of each peripheral chip select with respect to the PBA contained in PACS register.

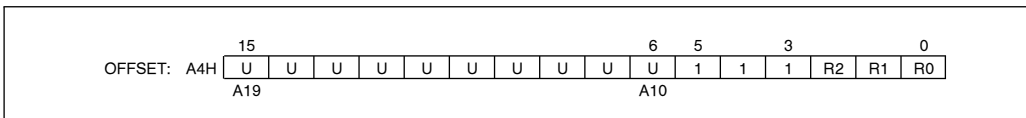

Figure 15. PACS Register

The user should program bits 15–6 to correspond to the desired peripheral base location. PACS bits 0–2 are used to specify READY mode for $\overline{\text{PCS0}}$ – $\overline{\text{PCS3}}$.

Table 10. PCS Address Ranges

PCS Line	Active between Locations
PCS0	PBA —PBA + 127
PCS1	PBA + 128—PBA + 255
PCS2	PBA + 256—PBA + 383
PCS3	PBA + 384—PBA + 511
PCS4	PBA + 512—PBA + 639
PCS5	PBA + 640—PBA + 767
PCS6	PBA + 768—PBA + 895

The mode of operation of the peripheral chip selects is defined by the MPCS register (which is also used to set the size of the mid-range memory chip-select block, see Figure 13). This register is located at offset A8H in the internal control block. Bit 7 is used to select the function of $\overline{\text{PCS5}}$ and $\overline{\text{PCS6}}$, while bit 6 is used to select whether the peripheral chip selects are mapped into memory or I/O space. Table 11 describes the programming of these bits. After reset, the contents of both the MPCS and the PACS registers are undefined, however none of the PCS lines will be active until both of the MPCS and PACS registers are accessed.

Table 11. MS, EX Programming Values

Bit	Description
MS	1 = Peripherals mapped into memory space. 0 = Peripherals mapped into I/O space.
EX	0 = 5 $\overline{\text{PCS}}$ lines. A1, A2 provided. 1 = 7 $\overline{\text{PCS}}$ lines. A1, A2 are not provided.

MPCS bits 0–2 are used to specify READY mode for $\overline{\text{PCS4}}$ – $\overline{\text{PCS6}}$ as outlined below.

READY Generation Logic

The M80C186 can generate a “READY” signal internally for each of the memory or peripheral $\overline{\text{CS}}$ lines. The number of WAIT states to be inserted for each peripheral or memory is programmable to provide 0–3 wait states for all accesses to the area for which the chip select is active. In addition, the M80C186 may be programmed to either ignore external READY for each chip-select range individually or to factor external READY with the integrated ready generator.

READY control consists of 3 bits for each $\overline{\text{CS}}$ line or group of lines generated by the M80C186. The interpretation of the ready bits is shown in Table 12.

Table 12. READY Bits Programming

R2	R1	R0	Number of WAIT States Generated
0	0	0	0 wait states, external RDY also used.
0	0	1	1 wait state inserted, external RDY also used.
0	1	0	2 wait states inserted, external RDY also used.
0	1	1	3 wait states inserted, external RDY also used.
1	0	0	0 wait states, external RDY ignored.
1	0	1	1 wait state inserted, external RDY ignored.
1	1	0	2 wait states inserted, external RDY ignored.
1	1	1	3 wait states inserted, external RDY ignored.

The internal ready generator operates in parallel with external READY, not in series if the external READY is used (R2 = 0). This means, for example, if the internal generator is set to insert two wait states, but activity on the external READY lines will insert four wait states, the processor will only insert four wait states, not six. This is because the two wait states generated by the internal generator overlapped the first two wait states generated by the external ready signal. Note that the external ARDY and SRDY lines are always ignored during cycles accessing internal peripherals.

R2–R0 of each control word specifies the READY mode for the corresponding block, with the exception of the peripheral chip selects: R2–R0 of PACS set the $\overline{\text{PCS0}}$ – $\overline{\text{PCS3}}$ READY mode, R2–R0 of MPCS set the $\overline{\text{PCS4}}$ – $\overline{\text{PCS6}}$ READY mode.

Chip Select/Ready Logic and Reset

Upon reset, the Chip-Select/Ready Logic will perform the following actions:

- All chip-select outputs will be driven HIGH.
- Upon leaving RESET, the $\overline{\text{UCS}}$ line will be programmed to provide chip selects to a 1K block with the accompanying READY control bits set at 011 to allow the maximum number of internal wait states in conjunction with external Ready consideration (i.e., UMCS resets to FFFBH).
- No other chip select or READY control registers have any predefined values after RESET. They will not become active until the CPU accesses their control registers. Both the PACS and MPCS registers must be accessed before the $\overline{\text{PCS}}$ lines will become active.

DMA CHANNELS

The M80C186 DMA controller provides two independent high-speed DMA channels. Data transfers can occur between memory and I/O spaces (e.g., Memory to I/O) or within the same space (e.g., Memory to Memory or I/O to I/O). Data can be transferred either in bytes (8 bits) or in words (16 bits) to or from even or odd addresses. Each DMA channel maintains both a 20-bit source and destination pointer which can be optionally incremented or decremented after each data transfer (by one or two depending on byte or word transfers). Each data transfer consumes 2 bus cycles (a minimum of 8 clocks), one cycle to fetch data and the other to store data.

DMA Operation

Each channel has six registers in the control block which define each channel's specific operation. The control registers consist of a 20-bit Source pointer (2

words), a 20-bit destination pointer (2 words), a 16-bit Transfer Counter, and a 16-bit Control Word. The format of the DMA Control Blocks is shown in Table 13. The Transfer Count Register (TC) specifies the number of DMA transfers to be performed. Up to 64K byte or word transfers can be performed with automatic termination. The Control Word defines the channel's operation (see Figure 17). All registers may be modified or altered during any DMA activity. Any changes made to these registers will be reflected immediately in DMA operation.

Table 13. DMA Control Block Format

Register Name	Register Address	
	Ch. 0	Ch. 1
Control Word	CAH	DAH
Transfer Count	C8H	D8H
Destination Pointer (upper 4 bits)	C6H	D6H
Destination Pointer	C4H	D4H
Source Pointer (upper 4 bits)	C2H	D2H
Source Pointer	C0H	D0H

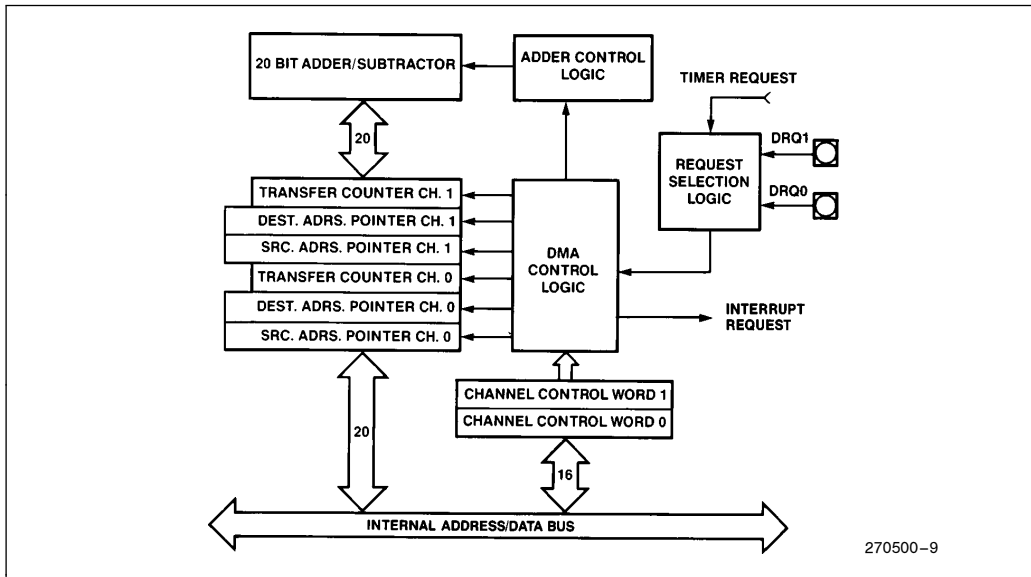

Figure 16. DMA Unit Block Diagram

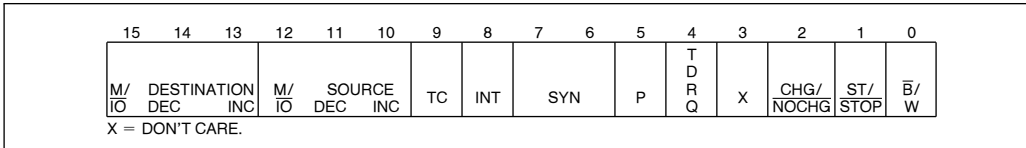

Figure 17. DMA Control Register

DMA Channel Control Word Register

Each DMA Channel Control Word determines the mode of operation for the particular M80C186 DMA channel. This register specifies:

- the mode of synchronization;
- whether bytes or words will be transferred;
- whether interrupts will be generated after the last transfer;
- whether DMA activity will cease after a programmed number of DMA cycles;
- the relative priority of the DMA channel with respect to the other DMA channel;
- whether the source pointer will be incremented, decremented, or maintained constant after each transfer;
- whether the source pointer addresses memory or I/O space;
- whether the destination pointer will be incremented, decremented, or maintained constant after each transfer; and
- whether the destination pointer will address memory or I/O space.

The DMA channel control registers may be changed while the channel is operating. However, any changes made during operation will affect the current DMA transfer.

DMA Control Word Bit Descriptions

- B/W:** Byte/Word (0/1) Transfers.
- ST/STOP:** Start/stop (1/0) Channel.
- CHG/NOCHG:** Change/Do not change (1/0) ST/STOP bit. If this bit is set when writing to the control word, the ST/STOP bit will be programmed by the write to the control word. If this bit is cleared when writing the control word, the ST/STOP bit will not be altered. This bit is not stored; it will always be a 0 on read.
- INT:** Enable Interrupts to CPU on Transfer Count termination.
- TC:** If set, DMA will terminate when the contents of the Transfer Count

- SYN** (2 bits) 00 No synchronization.
- SOURCE:INC** (2 bits) 01 Source synchronization.
10 Destination synchronization.
11 Unused.
- DEST:** M/IO Source pointer is in M/IO space (1/0).
DEC Decrement source pointer by 1 or 2 (depends on B/W) after each transfer.
INC Increment destination pointer by 1 or 2 (B/W) after each transfer.
- P** M/IO Destination pointer is in M/IO space (1/0).
DEC Decrement destination pointer by 1 or 2 (depending on B/W) after each transfer.
Channel priority—relative to other channel.
0 low priority.
1 high priority.
Channels will alternate cycles if both set at same priority level.
- TDRQ** 0: Disable DMA requests from timer 2.
1: Enable DMA requests from timer 2.
- Bit 3** Bit 3 is not used.

register reach zero. The ST/STOP bit will also be reset at this point if TC is set. If this bit is cleared, the DMA unit will decrement the transfer count register for each DMA cycle, but the DMA transfer will not stop when the contents of the TC register reach zero.

NOTE:

When unsynchronized transfers are specified, the TC bit will be ignored and the ST bit will be cleared upon the transfer count reaching zero, stopping the channel.

If both INC and DEC are specified for the same pointer, the pointer will remain constant after each cycle.

DMA Destination and Source Pointer Registers

Each DMA channel maintains a 20-bit source and a 20-bit destination pointer. Each of these pointers takes up two full 16-bit registers in the peripheral control block. The lower four bits of the upper register contain the upper four bits of the 20-bit physical address (see Figure 18). These pointers may be individually incremented or decremented after each transfer. If word transfers are performed the pointer is incremented or decremented by two. Each pointer may point into either memory or I/O space. Since the DMA channels can perform transfers to or from odd addresses, there is no restriction on values for the pointer registers. Higher transfer rates can be obtained if all word transfers are performed to even addresses, since this will allow data to be accessed in a single memory access.

DMA Transfer Count Register

Each DMA channel maintains a 16-bit transfer count register (TC). This register is decremented after every DMA cycle, regardless of the state of the TC bit in the DMA Control Register. If the TC bit in the DMA control word is set or if unsynchronized transfers are programmed, however, DMA activity will terminate when the transfer count register reaches zero.

DMA Requests

Data transfers may be either source or destination synchronized, that is either the source of the data or the destination of the data may request the data transfer. In addition, DMA transfers may be unsynchronized; that is, the transfer will take place continually until the correct number of transfers has occurred. When source or unsynchronized transfers are performed, the DMA channel may begin another transfer immediately after the end of a previous DMA transfer. This allows a complete transfer to take place every 2 bus cycles or eight clock cycles (assuming no wait states). No prefetching occurs when destination synchronization is performed, however. Data will not be fetched from the source address until the destination device signals that it is ready to receive it. When destination synchronized transfers are requested, the DMA controller will relinquish control of the bus after every transfer. If no other bus activity is initiated, another DMA cycle will begin after two processor clocks. This is done to allow the destination device time to remove its request if another transfer is not desired. Since the DMA controller will relinquish the bus, the CPU can initiate a bus cycle. As a result, a complete bus cycle will often be inserted between destination synchronized transfers. These lead to the maximum DMA transfer rates shown in Table 14.

Table 14. Maximum DMA Transfer Rates

Type of Synchronization Selected	CPU Running	CPU Halted
Unsynchronized	2.5MBytes/sec	2.5MBytes/sec
Source Synch	2.5MBytes/sec	2.5MBytes/sec
Destination Synch	1.7MBytes/sec	2.0MBytes/sec

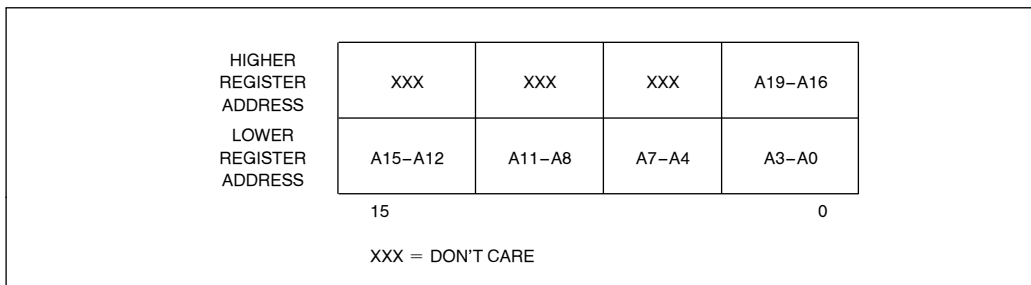

Figure 18. DMA Memory Pointer Register Format

DMA Acknowledge

No explicit DMA acknowledge pulse is provided. Since both source and destination pointers are maintained, a read from a requesting source, or a write to a requesting destination, should be used as the DMA acknowledge signal. Since the chip-select lines can be programmed to be active for a given block of memory or I/O space, and the DMA pointers can be programmed to point to the same given block, a chip-select line could be used to indicate a DMA acknowledge.

DMA Priority

The DMA channels may be programmed such that one channel is always given priority over the other, or they may be programmed such as to alternate cycles when both have DMA requests pending. DMA cycles always have priority over internal CPU cycles except between locked memory accesses or word accesses to odd memory locations; however, an external bus hold takes priority over an internal DMA cycle. Because an interrupt request cannot suspend a DMA operation and the CPU cannot access memory during a DMA cycle, interrupt latency time will suffer during sequences of continuous DMA cycles. An NMI request, however, will cause all internal DMA activity to halt. This allows the CPU to quickly respond to the NMI request.

DMA Programming

DMA cycles will occur whenever the ST/STOP bit of the Control Register is set. If synchronized transfers

are programmed, a DRQ must also have been generated. Therefore the source and destination transfer pointers, and the transfer count register (if used) must be programmed before this bit is set.

Each DMA register may be modified while the channel is operating. If the CHG/NOCHG bit is cleared when the control register is written, the ST/STOP bit of the control register will not be modified by the write. If multiple channel registers are modified, it is recommended that a LOCKED string transfer be used to prevent a DMA transfer from occurring between updates to the channel registers.

DMA Channels and Reset

Upon RESET, the DMA channels will perform the following actions:

- The Start/Stop bit for each channel will be reset to STOP.
- Any transfer in progress is aborted.

TIMERS

The M80C186 provides three internal 16-bit programmable timers (see Figure 19). Two of these are highly flexible and are connected to four external pins (2 per timer). They can be used to count external events, time external events, generate nonrepetitive waveforms, etc. The third timer is not connected to any external pins, and is useful for real-time coding and time delay applications. In addition, this third timer can be used as a prescaler to the other two, or as a DMA request source.

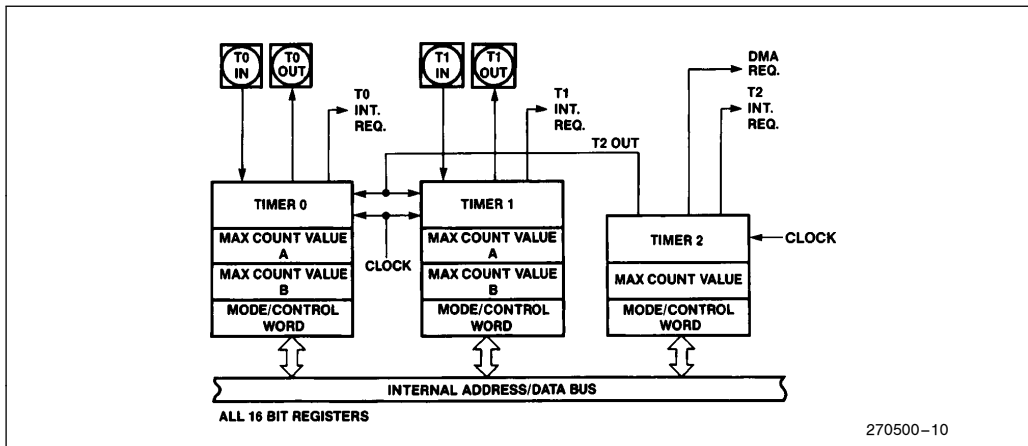

Figure 19. Timer Block Diagram

Timer Operation

The timers are controlled by 11 16-bit registers in the internal peripheral control block. The configuration of these registers is shown in Table 15. The count register contains the current value of the timer. It can be read or written at any time independent of whether the timer is running or not. The value of this register will be incremented for each timer event. Each of the timers is equipped with a MAX COUNT register, which defines the maximum count the timer will reach. After reaching the MAX COUNT register value, the timer count value will reset to zero during that same clock, i.e., the maximum count value is never stored in the count register itself. Timers 0 and 1 are, in addition, equipped with a second MAX COUNT register, which enables the timers to alternate their count between two different MAX COUNT values programmed by the user. If a single MAX COUNT register is used, the timer output pin will switch LOW for a single clock, 1 clock after the maximum count value has been reached. In the dual MAX COUNT register mode, the output pin will indicate which MAX COUNT register is currently in use, thus allowing nearly complete freedom in selecting waveform duty cycles. For the timers with two MAX COUNT registers, the RIU bit in the control register determines which is used for the comparison.

Each timer gets serviced every fourth CPU-clock cycle, and thus can operate at speeds up to one-quarter the internal clock frequency (one-eighth the crystal rate). External clocking of the timers may be done at up to a rate of one-quarter of the internal CPU-clock rate. Due to internal synchronization and pipelining of the timer circuitry, a timer output may take up to 6 clocks to respond to any individual clock or gate input.

Since the count registers and the maximum count registers are all 16 bits wide, 16 bits of resolution are provided. Any Read or Write access to the timers will add one wait state to the minimum four-clock bus cycle, however. This is needed to synchronize and coordinate the internal data flows between the internal timers and the internal bus.

The timers have several programmable options.

- All three timers can be set to halt or continue on a terminal count.
- Timers 0 and 1 can select between internal and external clocks, alternate between MAX COUNT registers and be set to retrigger on external events.
- The timers may be programmed to cause an interrupt on terminal count.

These options are selectable via the timer mode/control word.

Timer Mode/Control Register

The mode/control register (see Figure 20) allows the user to program the specific mode of operation or check the current programmed status for any of the three integrated timers.

Table 15. Timer Control Block Format

Register Name	Register Offset		
	Tmr. 0	Tmr. 1	Tmr. 2
Mode/Control Word	56H	5EH	66H
Max Count B	54H	5CH	not present
Max Count A	52H	5AH	62H
Count Register	50H	58H	60H

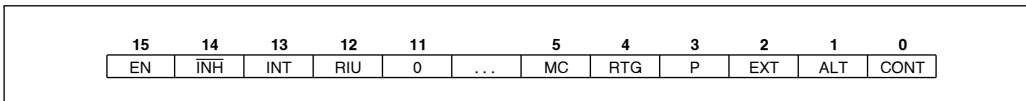

Figure 20. Timer Mode/Control Register

ALT:

The ALT bit determines which of two MAX COUNT registers is used for count comparison. If ALT = 0, register A for that timer is always used, while if ALT = 1, the comparison will alternate between register A and register B when each maximum count is reached. This alternation allows the user to change one MAX COUNT register while the other is being used, and thus provides a method of generating non-repetitive waveforms. Square waves and pulse outputs of any duty cycle are a subset of available signals obtained by not changing the final count registers. The ALT bit also determines the function of the timer output pin. If ALT is zero, the output pin will go LOW for one clock, the clock after the maximum count is reached. If ALT is one, the output pin will reflect the current MAX COUNT register being used (0/1 for B/A).

CONT:

Setting the CONT bit causes the associated timer to run continuously, while resetting it causes the timer to halt upon maximum count. If COUNT = 0 and ALT = 1, the timer will count to the MAX COUNT register A value, reset, count to the register B value, reset, and halt.

EXT:

The external bit selects between internal and external clocking for the timer. The external signal may be asynchronous with respect to the M80C186 clock. If this bit is set, the timer will count LOW-to-HIGH transitions on the input pin. If cleared, it will count an internal clock while using the input pin for control. In this mode, the function of the external pin is defined by the RTG bit. The maximum input to output transition latency time may be as much as 6 clocks. However, clock inputs may be pipelined as closely together as every 4 clocks without losing clock pulses.

P:

The prescaler bit is ignored unless internal clocking has been selected (EXT = 0). If the P bit is a zero, the timer will count at one-fourth the internal CPU clock rate. If the P bit is a one, the output of timer 2 will be used as a clock for the timer. Note that the user must initialize and start timer 2 to obtain the prescaled clock.

RTG:

Retrigger bit is only active for internal clocking (EXT = 0). In this case it determines the control function provided by the input pin.

If RTG = 0, the input level gates the internal clock on and off. If the input pin is HIGH, the timer will count; if the input pin is LOW, the timer will hold its value. As indicated previously, the input signal may be asynchronous with respect to the M80C186 clock.

When RTG = 1, the input pin detects LOW-to-HIGH transitions. The first such transition starts the timer running, clearing the timer value to zero on the first clock, and then incrementing thereafter. Further transitions on the input pin will again reset the timer to zero, from which it will start counting up again. If CONT = 0, when the timer has reached maximum count, the EN bit will be cleared, inhibiting further timer activity.

EN:

The enable bit provides programmer control over the timer's RUN/HALT status. When set, the timer is enabled to increment subject to the input pin constraints in the internal clock mode (discussed previously). When cleared, the timer will be inhibited from counting. All input pin transitions during the time EN is zero will be ignored. If CONT is zero, the EN bit is automatically cleared upon maximum count.

INH:

The inhibit bit allows for selective updating of the enable (EN) bit. If INH is a one during the write to the mode/control word, then the state of the EN bit will be modified by the write. If INH is a zero during the write, the EN bit will be unaffected by the operation. This bit is not stored; it will always be a 0 on a read.

INT:

When set, the INT bit enables interrupts from the timer, which will be generated on every terminal count. If the timer is configured in dual MAX COUNT register mode, an interrupt will be generated each time the value in MAX COUNT register A is reached, and each time the value in MAX COUNT register B is reached. If this enable bit is cleared after the interrupt request has been generated, but before a pending interrupt is serviced, the interrupt request will still be in force. (The request is latched in the Interrupt Controller).

MC:

The Maximum Count bit is set whenever the timer reaches its final maximum count value. If the timer is configured in dual MAX COUNT register mode, this bit will be set each time the value in MAX COUNT register A is reached, and each time the value in MAX COUNT register B is reached. This bit is set

regardless of the timer's interrupt-enable bit. The MC bit gives the user the ability to monitor timer status through software instead of through interrupts.

Programmer intervention is required to clear this bit.

RIU:

The Register In Use bit indicates which MAX COUNT register is currently being used for comparison to the timer count value. A zero value indicates register A. The RIU bit cannot be written, i.e., its value is not affected when the control register is written. It is always cleared when the ALT bit is zero.

Not all mode bits are provided for timer 2. Certain bits are hardwired as indicated below:

$$\text{ALT} = 0, \text{EXT} = 0, \text{P} = 0, \text{RTG} = 0, \text{RIU} = 0$$

Count Registers

Each of the three timers has a 16-bit count register. The current contents of this register may be read or written by the processor at any time. If the register is written into while the timer is counting, the new value will take effect in the current count cycle.

Max Count Registers

Timers 0 and 1 have two MAX COUNT registers, while timer 2 has a single MAX COUNT register. These contain the number of events the timer will count. In timers 0 and 1, the MAX COUNT register used can alternate between the two max count values whenever the current maximum count is reached. The condition which causes a timer to reset is equivalent between the current count value and the max count being used. This means that if the count is changed to be above the max count value, or if the max count value is changed to be below the current value, the timer will not reset to zero, but rather will count to its maximum value, "wrap around" to zero, then count until the max count is reached.

Timers and Reset

Upon RESET, the Timers will perform the following actions:

- All EN (Enable) bits are reset preventing timer counting.
- All SEL (Select) bits are reset to zero. This selects MAX COUNT register A, resulting in the Timer Out pins going HIGH upon RESET.

INTERRUPT CONTROLLER

The M80C186 can receive interrupts from a number of sources, both internal and external. The internal interrupt controller serves to merge these requests on a priority basis, for individual service by the CPU.

Internal interrupt sources (Timers and DMA channels) can be disabled by their own control registers or by mask bits within the interrupt controller. The M80C186 interrupt controller has its own control register that set the mode of operation for the controller.

The interrupt controller will resolve priority among requests that are pending simultaneously. Nesting is provided so interrupt service routines for lower priority interrupts may themselves be interrupted by higher priority interrupts. A block diagram of the interrupt controller is shown in Figure 21.

The M80C186 has a special slave mode in which the internal interrupt controller acts as a slave to an external master. The controller is programmed into this mode by setting bit 14 in the peripheral control block relocation register. (See Slave Mode section.)

MASTER MODE OPERATION

Interrupt Controller External Interface

For external interrupt sources, five dedicated pins are provided. One of these pins is dedicated to NMI, non-maskable interrupt. This is typically used for power-fail interrupts, etc. The other four pins may function either as four interrupt input lines with internally generated interrupt vectors, as an interrupt line and an interrupt acknowledge line (called the "cascade mode") along with two other input lines with internally generated interrupt vectors, or as two interrupt input lines and two dedicated interrupt acknowledge output lines. When the interrupt lines are configured in cascade mode, the M80C186 interrupt controller will not generate internal interrupt vectors.

External sources in the cascade mode use externally generated interrupt vectors. When an interrupt is acknowledged, two INTA cycles are initiated and the vector is read into the M80C186 on the second cycle. The capability to interface to external M82C59A programmable interrupt controllers is thus provided when the inputs are configured in cascade mode.



Interrupt Controller Modes of Operation

The basic modes of operation of the interrupt controller in master mode are similar to the M82C59A. The interrupt controller responds indentially to internal interrupts in all three modes: the difference is only in the interpretation of function of the four external interrupt pins. The interrupt controller is set into one of these three modes by programming the correct bits in the INT0 and INT1 control registers. The modes of interrupt controller operation are as follows:

Fully Nested Mode

When in the fully nested mode four pins are used as direct interrupt requests as in Figure 22. The vectors for these four inputs are generated internally. An in-service bit is provided for every interrupt source. If a lower-priority device requests an interrupt while the in service bit (IS) is set, no interrupt will be generated by the interrupt controller. In addition, if another interrupt request occurs from the same interrupt source while the in-service bit is set, no interrupt will be generated by the interrupt controller. This allows interrupt service routines to operate with interrupts enabled without being themselves interrupted by lower-priority interrupts. Since interrupts are enabled, higher-priority interrupts will be serviced.

When a service routine is completed, the proper IS bit must be reset by writing the proper pattern to the EOI register. This is required to allow subsequent interrupts from this interrupt source and to allow servicing of lower-priority interrupts. An EOI com-

mand is issued at the end of the service routine just before the issuance of the return from interrupt instruction. If the fully nested structure has been upheld, the next highest-priority source with its IS bit set is then serviced.

Cascade Mode

The M80C186 has four interrupt pins and two of them have dual functions. In the fully nested mode the four pins are used as direct interrupt inputs and the corresponding vectors are generated internally. In the cascade mode, the four pins are configured into interrupt input-dedicated acknowledge signal pairs. The interconnection is shown in Figure 23. INT0 is an interrupt input interfaced to an M82C59A, while INT2/INTA0 serves as the dedicated interrupt acknowledge signal to that peripheral. The same is true for INT1 and INT3/INTA1. Each pair can selectively be placed in the cascade or non-cascade mode by programming the proper value into INT0 and INT1 control registers. The use of the dedicated acknowledge signals eliminates the need for the use of external logic to generate INTA and device select signals.

The primary cascade mode allows the capability to serve up to 128 external interrupt sources through the use of external master and slave M82C59As. Three levels of priority are created, requiring priority resolution in the M80C186 interrupt controller, the master M82C59As, and the slave M82C59As. If an external interrupt is serviced, one IS bit is set at each of these levels. When the interrupt service routine is completed, up to three end-of-interrupt commands must be issued by the programmer.

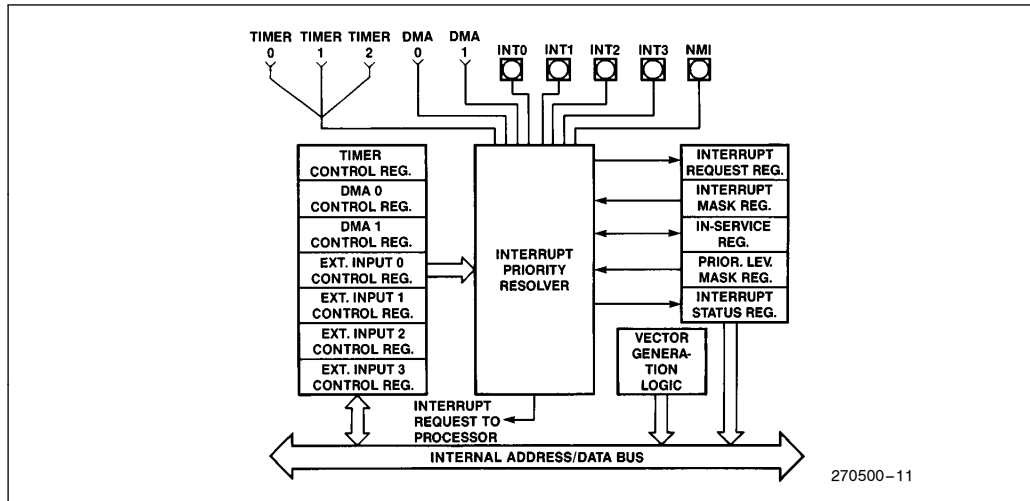

Figure 21. Interrupt Controller Block Diagram

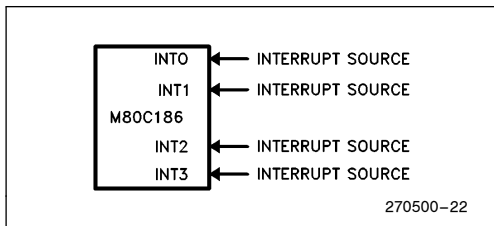

Figure 22. Fully Nested (Direct) Mode Interrupt Controller Connections

Special Fully Nested Mode

This mode is entered by setting the SFNM bit in INT0 or INT1 control register. It enables complete nestability with external M82C59A masters. Normally, an interrupt request from an interrupt source will not be recognized unless the in-service bit for that source is reset. If more than one interrupt source is connected to an external interrupt controller, all of the interrupts will be funneled through the same M80C186 interrupt request pin. As a result, if the external interrupt controller receives a higher-priority interrupt, its interrupt will not be recognized by the M80C186 controller until the M80C186 in-service bit is reset. In special fully nested mode, the M80C186 interrupt controller will allow interrupts from an external pin regardless of the state of the in-service bit for an interrupt source in order to allow multiple interrupts from a single pin. An in-service bit will continue to be set, however, to inhibit interrupts from other lower-priority M80C186 interrupt sources.

Special procedures should be followed when resetting IS bits at the end of interrupt service routines. Software polling of the external master's IS register is required to determine if there is more than one bit set. If so, the IS bit in the M80C186 remains active and the next interrupt service routine is entered.

Operation in a Polled Environment

The controller may be used in a polled mode if interrupts are undesirable. When polling, the processor disables interrupts and then polls the interrupt controller whenever it is convenient. Polling the interrupt controller is accomplished by reading the Poll Word (Figure 32). Bit 15 in the poll word indicates to the processor that an interrupt of high enough priority is requesting service. Bits 0–4 indicate to the processor the type vector of the highest-priority source requesting service. Reading the Poll Word causes the In-Service bit of the highest priority source to be set.

It is desirable to be able to read the Poll Word information without guaranteeing service of any pending

interrupt, i.e., not set the indicated in-service bit. The M80C186 provides a Poll Status Word in addition to the conventional Poll Word to allow this to be done. Poll Word information is duplicated in the Poll Status Word, but reading the Poll Status Word does not set the associated in-service bit. These words are located in two adjacent memory locations in the register file.

Master Mode Features

Programmable Priority

The user can program the interrupt sources into any of eight different priority levels. The programming is done by placing a 3-bit priority level (0–7) in the control register of each interrupt source. (A source with a priority level of 4 has higher priority over all priority levels from 5 to 7. Priority registers containing values lower than 4 have greater priority). All interrupt sources have preprogrammed default priority levels (see Table 4).

If two requests with the same programmed priority level are pending at once, the priority ordering scheme shown in Table 4 is used. If the serviced interrupt routine reenables interrupts, it allows other requests to be serviced.

End-of-Interrupt Command

The end-of-interrupt (EOI) command is used by the programmer to reset the In-Service (IS) bit when an interrupt service routine is completed. The EOI command is issued by writing the proper pattern to the EOI register. There are two types of EOI commands, specific and nonspecific. The nonspecific command does not specify which IS bit is reset. When issued, the interrupt controller automatically resets the IS bit of the highest priority source with an active service routine. A specific EOI command requires that the programmer send the interrupt vector type to the interrupt controller indicating which source's IS bit is to be reset. This command is used when the fully nested structure has been disturbed or the highest priority IS bit that was set does not belong to the service routine in progress.

Trigger Mode

The four external interrupt pins can be programmed in either edge- or level-trigger mode. The control register for each external source has a level-trigger mode (LTM) bit. All interrupt inputs are active HIGH. In the edge sense mode or the level-trigger mode, the interrupt request must remain active (HIGH) until the interrupt request is acknowledged by the



M80C186 CPU. In the edge-sense mode, if the level remains high after the interrupt is acknowledged, the input is disabled and no further requests will be generated. The input level must go LOW for at least one clock cycle to reenables the input. In the level-trigger mode, no such provision is made: holding the interrupt input HIGH will cause continuous interrupt requests.

Interrupt Vectoring

The M80C186 Interrupt Controller will generate interrupt vectors for the integrated DMA channels and the integrated Timers. In addition, the Interrupt Controller will generate interrupt vectors for the external interrupt lines if they are not configured in Cascade or Special Fully Nested Mode. The interrupt vectors generated are fixed and cannot be changed (see Table 4).

Interrupt Controller Registers

The Interrupt Controller register model is shown in Figure 24. It contains 15 registers. All registers can both be read or written unless specified otherwise.

In-Service Register

This register can be read from or written into. The format is shown in Figure 25. It contains the In-Service bit for each of the interrupt sources. The In-Service bit is set to indicate that a source's service routine is in progress. When an In-Service bit is set, the interrupt controller will not generate interrupts to the CPU when it receives interrupt requests from devices with a lower programmed priority level. The TMR bit is the In-Service bit for all three timers; the D0 and D1 bits are the In-Service bits for the two DMA channels; the I0–I3 are the In-Service bits for the external interrupt pins. The IS bit is set when the

processor acknowledges an interrupt request either by an interrupt acknowledge or by reading the poll register. The IS bit is reset at the end of the interrupt service routine by an end-of-interrupt command issued by the CPU.

Interrupt Request Register

The internal interrupt sources have interrupt request bits inside the interrupt controller. The format of this register is shown in Figure 25. A read from this register yields the status of these bits. The TMR bit is the logical OR of all timer interrupt requests. D0 and D1 are the interrupt request bits for the DMA channels.

The state of the external interrupt input pins is also indicated. The state of the external interrupt pins is not a stored condition inside the interrupt controller, therefore the external interrupt bits cannot be written. The external interrupt request bits show exactly when an interrupt request is given to the interrupt controller, so if edge-triggered mode is selected, the bit in the register will be HIGH only after an inactive-to-active transition. For internal interrupt sources, the register bits are set when a request arrives and are reset when the processor acknowledges the requests.

Writes to the interrupt request register will affect the D0 and D1 interrupt request bits. Setting either bit will cause the corresponding interrupt request while clearing either bit will remove the corresponding interrupt request. All other bits in the register are read-only.

Mask Register

This is a 16-bit register that contains a mask bit for each interrupt source. The format for this register is shown in Figure 25. A one in a bit position corre-

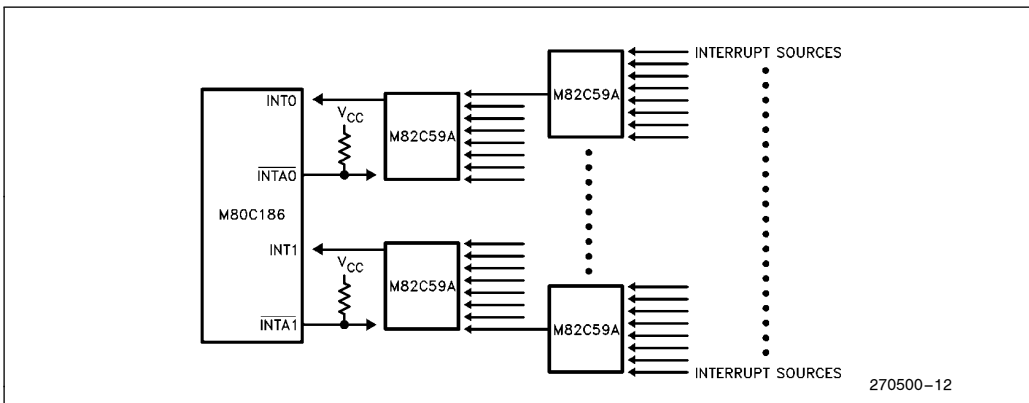

Figure 23. Cascade and Special Fully Nested Mode Interrupt Controller Connections

sponding to a particular source serves to mask the source from generating interrupts. These mask bits are the exact same bits which are used in the individual control registers; programming a mask bit using the mask register will also change this bit in the individual control registers, and vice versa.

	OFFSET
INT3 CONTROL REGISTER	3EH
INT2 CONTROL REGISTER	3CH
INT1 CONTROL REGISTER	3AH
INT0 CONTROL REGISTER	38H
DMA 1 CONTROL REGISTER	36H
DMA 0 CONTROL REGISTER	34H
TIMER CONTROL REGISTER	32H
INTERRUPT STATUS REGISTER	30H
INTERRUPT REQUEST REGISTER	2EH
IN-SERVICE REGISTER	2CH
PRIORITY MASK REGISTER	2AH
MASK REGISTER	28H
POLL STATUS REGISTER	26H
POLL REGISTER	24H
EOI REGISTER	22H

Figure 24. Interrupt Controller Registers (Master Mode)

Priority Mask Register

This register is used to mask all interrupts below particular interrupt priority levels. The format of this register is shown in Figure 26. The code in the lower three bits of this register inhibits interrupts of priority lower (a higher priority number) than the code specified. For example, 100 written into this register masks interrupts of level five (101), six (110), and seven (111). The register is reset to seven (111) upon RESET so no interrupts are masked due to priority number.

Interrupt Status Register

This register contains general interrupt controller status information. The format of this register is shown in Figure 27. The bits in the status register have the following functions:

DHLT: DMA Halt Transfer; setting this bit halts all DMA transfers. It is automatically set whenever a non-maskable interrupt occurs, and it is reset when an IRET instruction is executed. The purpose of this bit is to allow prompt service of all non-maskable interrupts. This bit may also be set by the programmer.

IRTx: These three bits represent the individual timer interrupt request bits. These bits are used to differentiate the timer interrupts, since the timer IR bit in the interrupt request register is the "OR" function of all timer interrupt request. Note that setting any one of these three bits initiates an interrupt request to the interrupt controller.

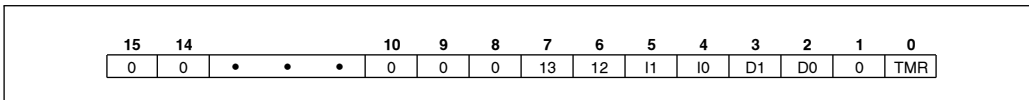

Figure 25. In-Service, Interrupt Request, and Mask Register Formats

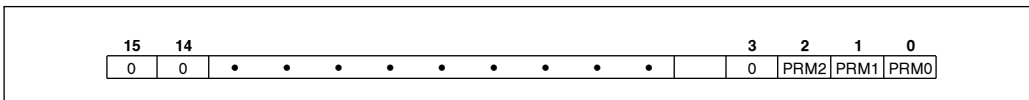

Figure 26. Priority Mask Register Format

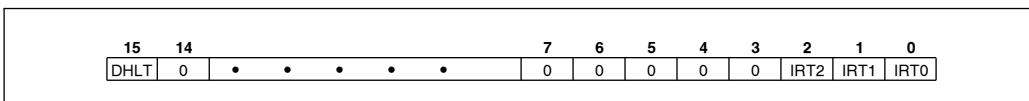

Figure 27. Interrupt Status Register Format (Master Mode)



Timer, DMA 0, 1; Control Register

These registers are the control words for all the internal interrupt sources. The format for these registers is shown in Figure 28. The three bit positions PR0, PR1, and PR2 represent the programmable priority level of the interrupt source. The MSK bit inhibits interrupt requests from the interrupt source. The MSK bits in the individual control registers are the exact same bits as are in the Mask Register; modifying them in the individual control registers will also modify them in the Mask Register, and vice versa.

INT0-INT3 Control Registers

These registers are the control words for the four external input pins. Figure 29 shows the format of the INT0 and INT1 Control registers; Figure 30 shows the format of the INT2 and INT3 Control registers. In cascade mode or special fully nested mode, the control words for INT2 and INT3 are not used.

The bits in the various control registers are encoded as follows:

- PRO-2: Priority programming information. Highest Priority = 000, Lowest Priority = 111
- LTM: Level-trigger mode bit. 1 = level-triggered; 0 = edge-triggered. Interrupt Input levels are active high. In level-triggered mode, an interrupt is generated whenever the external line is high. In edge-triggered mode, an interrupt will be generated only when this

level is preceded by an inactive-to-active transition on the line. In both cases, the level must remain active until the interrupt is acknowledged.

- MSK: Mask bit, 1 = mask; 0 = non-mask.
- C: Cascade mode bit, 1 = cascade; 0 = direct
- SFNM: Special fully nested mode bit, 1 = SFNM

EOI Register

The end of the interrupt register is a command register which can only be written into. The format of this register is shown in Figure 30. It initiates an EOI command when written to by the M80C186 CPU.

The bits in the EOI register are encoded as follows:

- S_x: Encoded information that specifies an interrupt source vector type as shown in Table 4. For example, to reset the In-Service bit for DMA channel 0, these bits should be set to 01010, since the vector type for DMA channel 0 is 10.

NOTE:

To reset the single In-Service bit for any of the three timers, the vector type for timer 0 (8) should be written in this register.

NSPEC/: A bit that determines the type of EOI command. Nonspecific = 1, Specific = 0.

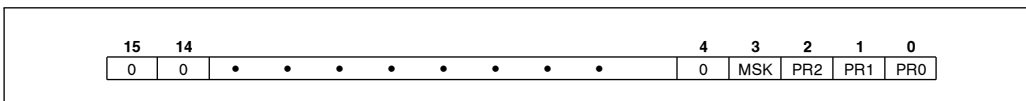

Figure 28. Timer/DMA Control Registers Formats

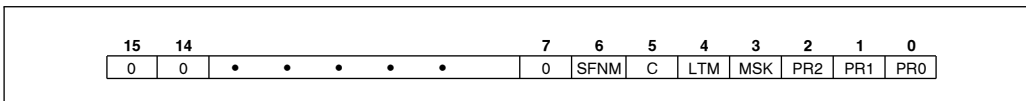

Figure 29. INT0/INT1 Control Register Formats

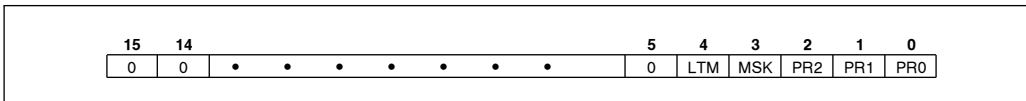

Figure 30. INT2/INT3 Control Register Formats



Poll and Poll Status Registers

These registers contain polling information. The format of these registers is shown in Figure 32. They can only be read. Reading the Poll register constitutes a software poll. This will set the IS bit of the highest priority pending interrupt. Reading the poll status register will not set the IS bit of the highest priority pending interrupt; only the status of pending interrupts will be provided.

Encoding of the Poll and Poll Status register bits are as follows:

S_x: Encoded information that indicates the vector type of the highest priority interrupting source. Valid only when INTREQ = 1.

INTREQ: This bit determines if an interrupt request is present. Interrupt Request = 1; no Interrupt Request = 0.

SLAVE MODE OPERATION

When slave mode is used, the internal M80C186 interrupt controller will be used as a slave controller to an external master interrupt controller. The internal M80C186 resources will be monitored by the internal interrupt controller, while the external controller functions as the system master interrupt controller.

Upon reset, the M80C186 will be in master mode. To provide for slave mode operation bit 14 of the relocation register should be set.

Because of pin limitations caused by the need to interface to an external M82C59A master, the internal interrupt controller will no longer accept external inputs. There are however, enough M80C186 interrupt controller inputs (internally) to dedicate one to each timer. In this mode, each timer interrupt source has its own mask bit, IS bit, and control word.

In slave mode each peripheral must be assigned a unique priority to ensure proper interrupt controller operation. Therefore, it is the programmer's responsibility to assign correct priorities and initialize interrupt control registers before enabling interrupts.

Slave Mode External Interface

The configuration of the M80C186 with respect to an external M82C59A master is shown in Figure 33. The INTO (Pin 45) input is used as the M80C186 CPU interrupt input. INT3 (Pin 41) functions as an output to send the M80C186 slave-interrupt-request to one of the 8 master-PIC-inputs.

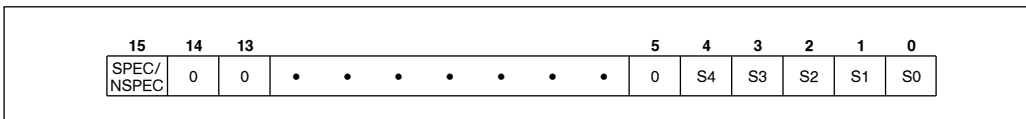

Figure 31. EOI Register Format

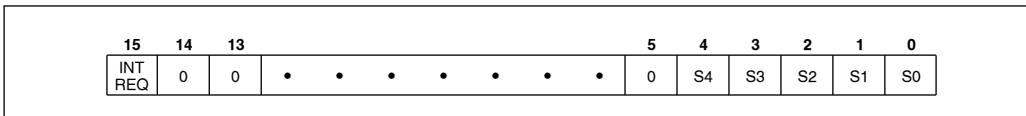

Figure 32. Poll and Poll Status Register Format

In-Service Register

This register can be read from or written into. It contains the in-service bit for each of the internal interrupt sources. The format for this register is shown in Figure 36. Bit positions 2 and 3 correspond to the DMA channels; positions 0, 4, and 5 correspond to the integral timers. The source's IS bit is set when the processor acknowledges its interrupt request.

Interrupt Request Register

This register indicates which internal peripherals have interrupt requests pending. The format of this register is shown in Figure 36. The interrupt request bits are set when a request arrives from an internal source, and are reset when the processor acknowledges the request. As in master mode, D0 and D1 are read/write; all other bits are read only.

Mask Register

The register contains a mask bit for each interrupt source. The format for this register is shown in Figure 36. If the bit in this register corresponding to a particular interrupt source is set, any interrupts from that source will be masked. These mask bits are exactly the same bits which are used in the individual control registers, i.e., changing the state of a mask bit in this register will also change the state of the mask bit in the individual interrupt control register corresponding to the bit.

Control Registers

These registers are the control words for all the internal interrupt sources. The format of these registers is shown in Figure 37. Each of the timers and both of the DMA channels have their own Control Register.

The bits of the Control Registers are encoded as follows:

- pr_x: 3-bit encoded field indicating a priority level for the source; note that each source must be programmed at specified levels.
- msk: mask bit for the priority level indicated by pr_x bits.

	OFFSET
LEVEL 5 CONTROL REGISTER (TIMER 2)	3AH
LEVEL 4 CONTROL REGISTER (TIMER 1)	38H
LEVEL 3 CONTROL REGISTER (DMA 1)	36H
LEVEL 2 CONTROL REGISTER (DMA 0)	34H
LEVEL 0 CONTROL REGISTER (TIMER 0)	32H
INTERRUPT STATUS REGISTER	30H
INTERRUPT-REQUEST REGISTER	2EH
IN-SERVICE REGISTER	2CH
PRIORITY-LEVEL MASK REGISTER	2AH
MASK REGISTER	28H
SPECIFIC EOI REGISTER	22H
INTERRUPT VECTOR REGISTER	20H

Figure 34. Interrupt Controller Registers (Slave Mode)

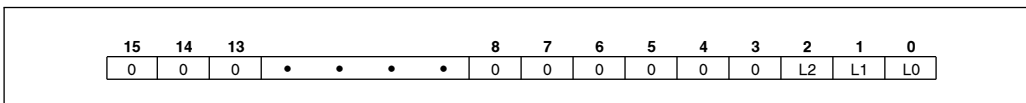

Figure 35. Specific EOI Register Format

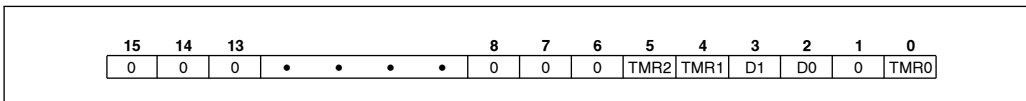

Figure 36. In-Service, Interrupt Request, and Mask Register Format

Interrupt Vector Register

This register provides the upper five bits of the interrupt vector address. The format of this register is shown in Figure 38. The interrupt controller itself provides the lower three bits of the interrupt vector as determined by the priority level of the interrupt request.

The format of the bits in this register is:

t_x : 5-bit field indicating the upper five bits of the vector address.

Priority-Level Mask Register

This register indicates the lowest priority-level interrupt which will be serviced.

The encoding of the bits in this register is:

m_x : 3-bit encoded field indication priority-level value. All levels of lower priority will be masked.

Interrupt Status Register

This register is defined as in master mode except that DHLT is not implemented (see Figure 27).

Interrupt Controller and Reset

Upon RESET, the interrupt controller will perform the following actions:

- All SFNM bits reset to 0, implying Fully Nested Mode.
- All PR bits in the various control registers set to 1. This places all sources at lowest priority (level 111).
- All LTM bits reset to 0, resulting in edge-sense mode.
- All Interrupt Service bits reset to 0.
- All Interrupt Request bits reset to 0.
- All MSK (Interrupt Mask) bits set to 1 (mask).
- All C (Cascade) bits reset to 0 (non-cascade).
- All PRM (Priority Mask) bits set to 1, implying no levels masked.
- Initialized to master mode.

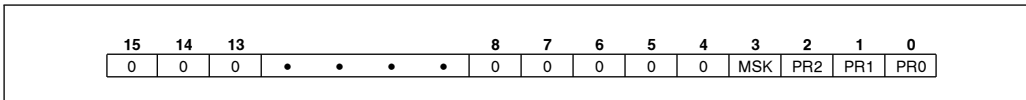

Figure 37. Control Word Format

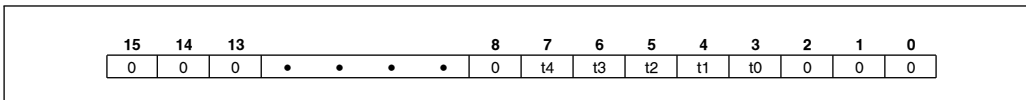

Figure 38. Interrupt Vector Register Format

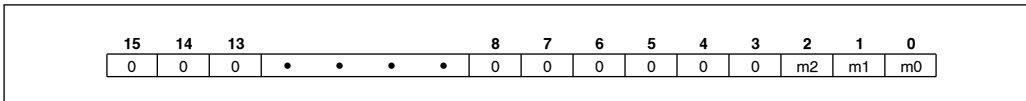

Figure 39. Priority Level Mask Register



Enhanced Mode Operation

In Enhanced Mode, the M80C186 will operate with Power-Save, DRAM refresh, and numerics coprocessor support in addition to all the Compatible Mode features.

In Compatible Mode the M80C186 operates with all the features of the NMOS M80186, with the exception of M8087 support (i.e. no numeric coprocessing is possible in Compatible Mode). Queue-Status information is still available for design purposes other than M8087 support.

All the Enhanced Mode features are completely masked when in Compatible Mode. A write to any of the Enhanced Mode registers will have no effect, while a read will not return any valid data.

Entering Enhanced Mode

If connected to a numerics coprocessor, this mode will be invoked automatically. Without a NPX, this mode can be entered by tying the RESET output signal from the M80C186 to the TEST/BUSY input.

Queue-Status Mode

The queue-status mode is entered by strapping the RD pin low. RD is sampled at RESET and if LOW, the M80C186 will reconfigure the ALE and WR pins to be QS0 and QS1 respectively. This mode is available on the M80C186 in both Compatible and Enhanced Modes and is identical to the NMOS M80186.

DRAM Refresh Control Unit Description

The Refresh Control Unit (RCU) automatically generates DRAM refresh bus cycles. The RCU operates only in Enhanced Mode. After a programmable period of time, the RCU generates a memory read request to the BIU. If the address generated during a refresh bus cycle is within the range of a properly programmed chip select, that chip select will be activated when the BIU executes the refresh bus cycle. The ready logic and wait states programmed for that region will also be in force. If no chip select is activated, then external ready is automatically required to terminate the refresh bus cycle.

If the HLDA pin is active when a DRAM refresh request is generated (indicating a bus hold condition), then the M80C186 will deactivate the HLDA pin in order to perform a refresh cycle. The circuit external to the M80C186 must remove the HOLD signal in order to execute the refresh cycle. The sequence of HLDA going inactive while HOLD is being held active can be used to signal a pending refresh request.

All registers controlling DRAM refresh may be read and written in Enhanced Mode. When the processor is operating in Compatible Mode, they are deselected and are therefore inaccessible. Some fields of these registers cannot be written and are always read as zeros.

DRAM Refresh Addresses

The address generated during a refresh cycle is determined by the contents of the MDRAM register (see Figure 40) and the contents of a 9-bit counter. Figure 41 illustrates the origin of each bit.

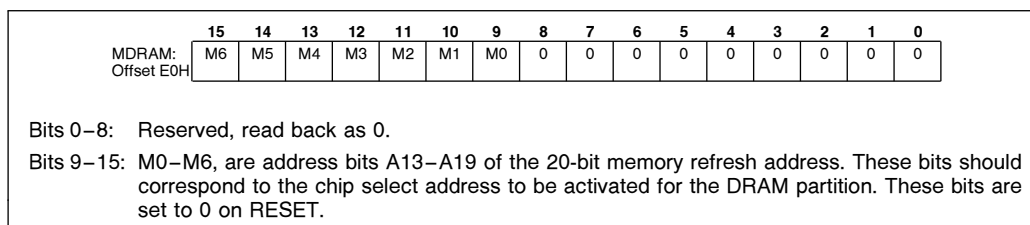

Figure 40. Memory Partition Register

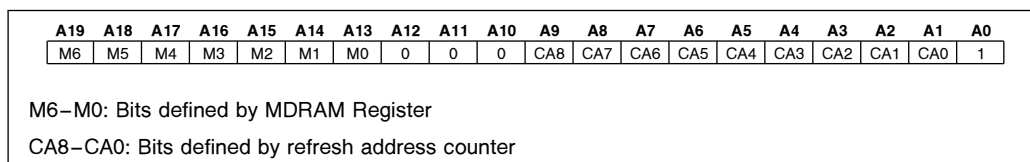

Figure 41. Addresses Generated by RCU

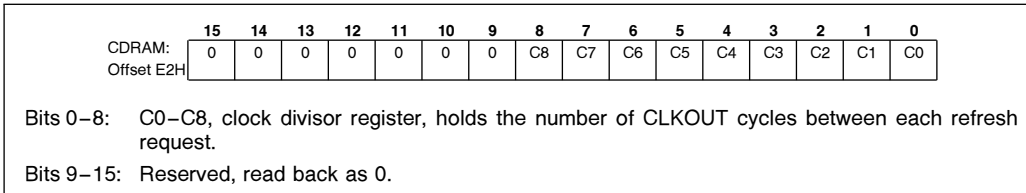

Figure 42. Clock Pre-Scaler Register

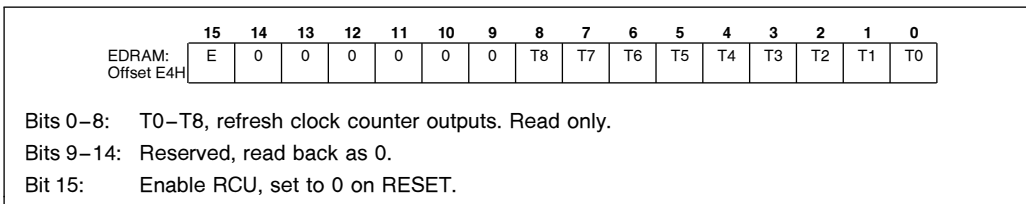

Figure 43. Enable RCU Register

Refresh Control Unit Programming and Operation

After programming the MDRAM and the CDRAM registers (Figures 40 and 42), the RCU is enabled by setting the “E” bit in the EDRAM register (Figure 43). The clock counter (T0–T8 of EDRAM) will be loaded from C0–C8 of CDRAM during T₃ of instruction cycle that sets the “E” bit. The clock counter is then decremented at each subsequent CLKOUT.

A refresh is requested when the value of the counter has reached 1 and the counter is reloaded from CDRAM. In order to avoid missing refresh requests, the value in the CDRAM register should always be at least 18 (12H). Clearing the “E” bit at anytime will clear the counter and stop refresh requests, but will not reset the refresh address counter.

POWER-SAVE CONTROL

Power Save Operation

The M80C186, when in Enhanced Mode, can enter a power saving state by internally dividing the clock-in frequency by a programmable factor. This divided

frequency is also available at the CLKOUT pin. The PDCON register contains the two-bit fields for selecting the clock division factor and the enable bit.

All internal logic, including the Refresh Control Unit and the timers, will have their clocks slowed down by the division factor. To maintain a real time count or a fixed DRAM refresh rate, these peripherals must be re-programmed when entering and leaving the power-save mode.

The power-save mode is exited whenever an interrupt is processed by automatically resetting the enable bit. If the power-save mode is to be re-entered after serving the interrupt, the enable bit will need to be reset in software before returning from the interrupt routine.

The internal clocks of the M80C186 will begin to be divided during the T₃ state of the instruction cycle that sets the enable bit. Clearing the enable bit will restore full speed in the T₃ state of that instruction.

At no time should the internal clock frequency be allowed to fall below 0.5 MHz. This is the minimum operational frequency of the M80C186. For example, an M80C186 running with a 12 MHz crystal (6 MHz CLOCKOUT) should never have a clock divisor greater than eight.

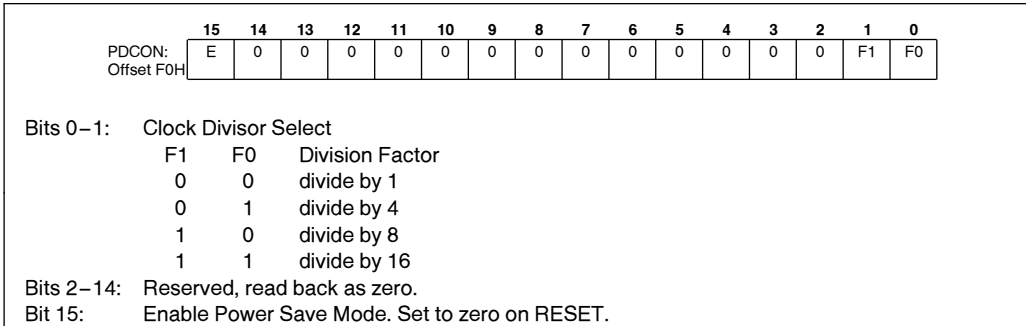

Figure 44. Power-Save Control Register

Numeric Coprocessor (NPX) Extension

Three of the mid-range memory chip selects are re-defined according to Table 16 when using the numerics coprocessor extension. The fourth chip select, $\overline{MCS2}$ functions as in compatible mode, and may be programmed for activity with ready logic and wait states accordingly. As in compatible mode, $\overline{MCS2}$ will function for one-fourth a programmed block size.

Table 16. \overline{MCS} Assignments

Compatible Mode	Enhanced Mode
$\overline{MCS0}$	PEREQ Processor Extension Request
$\overline{MCS1}$	ERROR NPX Error
$\overline{MCS2}$	$\overline{MCS2}$ Mid-Range Chip Select
$\overline{MCS3}$	NPS Numeric Processor Select

Four port addresses are assigned to the NPX for 16-bit reads and writes by the M80C186. Table 17 shows the port definitions. These ports are not accessible by using the M80C186 I/O instructions. However, numerics operations will cause a \overline{PCS} line to be activated if it is properly programmed for this I/O range.

Table 17. Numerics Coprocessor I/O Port Assignments

I/O Address	Read Definition	Write Definition
00F8H	Status/Control	Opcode
00FAH	Data	Data
00FCH	reserved	CS:IP, DS:EA
00FEH	Opcode Status	reserved

“ONCE” Test Mode

To facilitate testing and inspection of devices when fixed into a target system, the M80C186 has a test mode available which allows all pins to be placed in a high-impedance state. “ONCE” stands for “ON Circuit Emulation”. When placed in this mode, the M80C186 will put all pins in the high-impedance state until RESET.

The ONCE mode is selected by tying the \overline{UCS} and the \overline{LCS} LOW during RESET. These pins are sampled on the low-to-high transition of the \overline{RES} pin. The \overline{UCS} and the \overline{LCS} pins have weak internal pull-up resistors similar to the \overline{RD} and $\overline{TEST}/\overline{BUSY}$ pins to guarantee proper normal operation.

ABSOLUTE MAXIMUM RATINGS*

Case Temperature under Bias . . . -55°C to $+125^{\circ}\text{C}$
 Storage Temperature -65°C to $+150^{\circ}\text{C}$
 Voltage on Any Pin with
 Respect to Ground -1.0V to $+7.0\text{V}$
 Package Power Dissipation 1W

NOTICE: This is a production data sheet. The specifications are subject to change without notice.

**WARNING: Stressing the device beyond the "Absolute Maximum Ratings" may cause permanent damage. These are stress ratings only. Operation beyond the "Operating Conditions" is not recommended and extended exposure beyond the "Operating Conditions" may affect device reliability.*

OPERATING CONDITIONS**MIL-STD-883**

Symbol	Description	Min	Max	Units
T_C	Case Temperature (Instant On)	-55	$+125$	$^{\circ}\text{C}$
V_{CC}	Digital Supply Voltage	4.75	5.25	V

MILITARY TEMPERATURE ONLY (MTO)

Symbol	Description	Min	Max	Units
T_C	Case Temperature (Instant On)	-55	$+125$	$^{\circ}\text{C}$
V_{CC}	Digital Supply Voltage	4.75	5.25	V

DC CHARACTERISTICS (Over Specified Operating Conditions)

Symbol	Parameter	Min	Max	Units	Comments
V_{IL}	Input Low Voltage	-0.5	$0.2 V_{CC} - 0.3$	V	
V_{IH}	Input High Voltage (All except X1 and $\overline{\text{RES}}$)	$0.2 V_{CC} + 1.1$	V_{CC}	V	
V_{IH1}	Input High Voltage ($\overline{\text{RES}}$)	3.0	V_{CC}	V	
V_{IH2}	Input High Voltage (ARDY/SRDY)	$0.2 V_{CC} + 1.3$	V_{CC}	V	
V_{OL}	Output Low Voltage		0.45	V	$I_{OL} = 2.5 \text{ mA}$ (S0, 1, 2) $I_{OL} = 2.0 \text{ mA}$ (others)
V_{OH}	Output High Voltage	2.4	V_{CC}	V	$I_{OH} = -2.4 \text{ mA}$ @ $2.4\text{V}^{(4)}$
		$0.8 V_{CC}$	V_{CC}	V	$I_{OH} = -200 \mu\text{A}$ @ $0.8 V_{CC}^{(4)}$
I_{CC}	Power Supply Current		160	mA	12.5 MHz ⁽³⁾
			140	mA	10 MHz ⁽³⁾
I_{PS}	Power Save Current	10 mA per MHz + 20		mA	Typical @ 25°C , $V_{CC} = 5.0\text{V}$
I_{LI}	Input Leakage Current		± 10	μA	$0.45\text{V} \leq V_{IN} \leq V_{CC}$
I_{LO}	Output Leakage Current		± 10	μA	$0.45\text{V} \leq V_{OUT} \leq V_{CC}^{(1)}$
V_{CLO}	Clock Output Low		0.5	V	$I_{CLO} = 4.0 \text{ mA}$
V_{CHO}	Clock Output High	$0.8 V_{CC}$		V	$I_{CHO} = -500 \mu\text{A}$

NOTES:

1. Pins being floated during HOLD or by invoking the ONCE Mode.
2. Characterization conditions are a) Frequency = 1 MHz; b) Unmeasured pins at GND; V_{IN} at $+5.0\text{V}$ or $+0.45\text{V}$.
3. Current is measured with the device in RESET with X1 and X2 driven and all other non-power pins open.
4. RD/QSMD, UCS, MSC0/PEREQ, MCSL/ERROR, and TEST/BUSY pins have internal pullup devices that are active at RESET. Excessive loading on these pins can cause the M80C186 to go into undesired modes of operation (e.g., Queue Status, ONCE) upon RESET.

DC CHARACTERISTICS (Over Specified Operating Conditions) (Continued)

Symbol	Parameter	Min	Max	Units	Comments
V _{CLI}	Clock Input Low Voltage (X1)	-0.5	0.6	V	
V _{CHI}	Clock Input High Voltage (X1)	3.9	V _{CC}	V	
C _{IN}	Input Capacitance		10	pF	@ 1 MHz ⁽²⁾
C _{IO}	I/O Capacitance		20	pF	@ 1 MHz ⁽²⁾

NOTES:

1. Pins being floated during HOLD or by invoking the ONCE Mode.
2. Characterization conditions are a) Frequency = 1 MHz; b) Unmeasured pins at GND; V_{IN} at +5.0V or +0.45V.
3. Current is measured with the device in RESET with X1 and X2 driven and all other non-power pins open.
4. RD/QSMD, UCS, MSC0/PEREQ, MCSL/ERROR, and TEST/BUSY pins have internal pullup devices that are active at RESET. Excessive loading on these pins can cause the M80C186 to go into undesired modes of operation (e.g., Queue Status, ONCE) upon RESET.

PIN TIMINGS
AC CHARACTERISTICS (Over Specified Operating Conditions)

All timings are measured at 1.5V and 100 pF loading on CLKOUT unless otherwise noted.
 All output test conditions are with C_L = 50–200 pF (10 MHz) and C_L = 50–100 pF (12.5 MHz).
 For AC tests, input V_{IL} = 0.45V and V_{IN} = 2.4V except at X₁ where V_{IH} = V_{CC} - 0.5V.

Symbol	Parameter	M80C186-10		M80C186-12		Unit	Comments
		Min	Max	Min	Max		
M80C186 TIMING REQUIREMENTS							
T _{DVCL}	Data In Setup (A/D)	20		20		ns	
T _{CLDX}	Data In Hold (A/D)	5		5		ns	
T _{ARYCH}	ARDY Resolution Transition Setup Time ⁽¹⁾	20		20		ns	
T _{ARYLCL}	Asynchronous Ready (ARDY) Setup Time	30		30		ns	
T _{CLARX}	ARDY Active Hold Time	15		15		ns	
T _{ARYCHL}	ARDY Inactive Hold Time	15		15		ns	
T _{SRYCL}	Synchronous Ready (SRDY) Transition Setup Time	20		20		ns	
T _{CLSRDY}	SRDY Transition Hold Time	20		20		ns	
T _{HVCL}	HOLD Setup ⁽¹⁾	20		20		ns	
T _{INVCH}	INTR, NMI, TEST, TMR IN Setup Time ⁽¹⁾	20		20		ns	
T _{INVCL}	DRQ0, DRQ1, Setup Time ⁽¹⁾	20		20		ns	
M80C186 MASTER INTERFACE TIMING RESPONSES							
T _{CLAV}	Address Valid Delay	5	50	5	37	ns	C _L = 50 pF–200 pF all outputs (except T _{CLTMV}) @ 10 MHz
T _{CLAX}	Address Hold	0		0		ns	
T _{CLAZ}	Address Float Delay	T _{CLAX}	30	T _{CLAX}	25	ns	
T _{CHCZ}	Command Lines Float Delay		40		33	ns	
T _{CHCV}	Command Lines Valid Delay (after Float)		45		37	ns	C _L = 50 pF–100 pF all outputs @ 12.5 MHz
T _{LHLL}	ALE Width (min)	T _{CLCL} - 30		T _{CLCL} - 30		ns	
T _{CHLH}	ALE Active Delay		30		25	ns	
T _{CHLL}	ALE Inactive Delay		30		25	ns	

PIN TIMINGS (Continued)

AC CHARACTERISTICS (Over Specified Operating Conditions) (Continued)

All timings are measured at 1.5V and 100 pF loading on CLKOUT unless otherwise noted.

All output test conditions are with $C_L = 50\text{--}200\text{ pF}$ (10 MHz) and $C_L = 50\text{--}100\text{ pF}$ (12.5 MHz).

For AC tests, input $V_{IL} = 0.45V$ and $V_{IN} = 2.4V$ except at X_1 where $V_{IH} = V_{CC} - 0.5V$.

Symbol	Parameter	M80C186-10		M80C186-12		Unit	Comments
		Min	Max	Min	Max		
M80C186 MASTER INTERFACE TIMING RESPONSES (Continued)							
T_{LLAX}	Address Hold to ALE Inactive (min)	$T_{CHCL} - 20$		$T_{CHCL} - 15$		ns	$C_L =$ 50 pF–200 pF – all outputs (except T_{CLTMV}) @ 10 MHz $C_L =$ 50 pF–100 pF all outputs @ 12.5 MHz
T_{CLDV}	Data Valid Delay	5	40	5	36	ns	
T_{CLDOX}	Data Hold Time	3		3		ns	
T_{WHDX}	Data Hold after \overline{WR} (min)	$T_{CLCL} - 34$		$T_{CLCL} - 20$		ns	
T_{CVCTV}	Control Active Delay 1	3	56	3	47	ns	
T_{CHCTV}	Control Active Delay 2	5	44	5	37	ns	
T_{CVCTX}	Control Inactive Delay	4	44	5	37	ns	
T_{CVDEX}	\overline{DEN} Inactive Delay (Non-Write Cycle)	5	56	5	47	ns	
T_{AZRL}	Address Float to \overline{RD} Active	0		0		ns	
T_{CLRRL}	\overline{RD} Active Delay	5	44	5	37	ns	
T_{CLRHL}	\overline{RD} Inactive Delay	5	44	5	37	ns	
t_{RHLH}	\overline{RD} Inactive to ALE High	$T_{CLCH} - 14$		$T_{CLCH} - 14$		ns	
T_{RHAV}	\overline{RD} Inactive to Address Active (min)	$T_{CLCL} - 40$		$T_{CLCL} - 20$		ns	
T_{CLHAV}	HLDA Valid Delay	5	40	4	33	ns	
T_{RLRH}	\overline{RD} Pulse Width (min)	$2T_{CLCL} - 46$		$2T_{CLCL} - 40$		ns	
T_{RVCH}	\overline{RD} Valid to Clock High	25		25		ns	
T_{WLWH}	\overline{WR} Pulse Width (min)	$2T_{CLCL} - 34$		$2T_{CLCL} - 30$		ns	
t_{WHLH}	\overline{WR} Inactive to ALE High	$T_{CLCH} - 14$		$T_{CLCH} - 14$		ns	
T_{WHDEX}	\overline{WR} Inactive to \overline{DEN} Inactive	$T_{CLCH} - 10$		$T_{CLCH} - 10$		ns	
T_{CSVLL}	Chip Select Valid to ALE Low	$T_{CLCH} - 14$		$T_{CLCH} - 14$		ns	
T_{AVLL}	Address Valid to ALE Low (min)	$T_{CLCH} - 19$		$T_{CLCH} - 15$		ns	
T_{CHSV}	Status Active Delay	5	45	5	35	ns	
T_{CLSH}	Status Inactive Delay	5	50	5	35	ns	
T_{CLTMV}	Timer Output Delay		48		40	ns	100 pF max @ 10 MHz

AC CHARACTERISTICS (Over Specified Operating Conditions) (Continued)

All timings are measured at 1.5V and 100 pF loading on CLKOUT unless otherwise noted.

 All output test conditions are with $C_L = 50\text{--}200$ pF (10 MHz) and $C_L = 50\text{--}100$ pF (12.5 MHz).

 For AC tests, input $V_{IL} = 0.45V$ and $V_{IN} = 2.4V$ except at X_1 where $V_{IH} = V_{CC} - 0.5V$.

Symbol	Parameter	M80C186-10		M80C186-12		Unit	Comments
		Min	Max	Min	Max		
M80C186 MASTER INTERFACE TIMING RESPONSES (Continued)							
T_{CLRO}	Reset Delay		48		40	ns	$C_L = 50\text{--}200$ pF All outputs (except T_{CLTMV}) @ 10 MHz $C_L = 50\text{--}100$ pF All Outputs @ 12.5 MHz
T_{CHQSV}	Queue Status Delay		28		28	ns	
T_{CHDX}	Status Hold Time	5		5		ns	
T_{AVCH}	Address Valid to Clock High	0		0			
T_{CLLV}	\overline{LOCK} Valid/Invalid Delay	5	45	5	40	ns	
T_{DXDL}	\overline{DEN} Inactive to DT/\overline{R} Low	0		0		ns	
M80C186 CHIP-SELECT TIMING RESPONSES							
T_{CLCSV}	Chip-Select Active Delay		45		33	ns	
T_{CXCSX}	Chip-Select Hold from Command Inactive	$T_{CLCH} - 10$		$T_{CLCH} - 10$		ns	
T_{CHCSX}	Chip-Select Inactive Delay	5	40	5	36	ns	
M80C186 CLKIN REQUIREMENTS Measurements taken with following conditions: External clock input to X1 and X2 not connected (float)							
T_{CKIN}	CLKIN Period	50	1000	40	1000	ns	
T_{CKHL}	CLKIN Fall Time		5		5	ns	3.5 to 1.0V ⁽¹⁾
T_{CKLH}	CLKIN Rise Time		5		5	ns	1.0 to 3.5V ⁽¹⁾
T_{CLCK}	CLKIN Low Time	23		18		ns	1.5V ⁽²⁾
T_{CHCK}	CLKIN High Time	23		18		ns	1.5V ⁽²⁾
M80C186 CLKOUT TIMING 200 pF load maximum for 10 MHz or less							
T_{CICO}	CLKIN to CLKOUT Skew		25		21	ns	
T_{CLCL}	CLKOUT Period	100	2000	80	2000	ns	
T_{CLCH}	CLKOUT Low Time (min)	$0.5 T_{CLCL} - 8$		$0.5 T_{CLCL} - 7$		ns	1.5V
T_{CHCL}	CLKOUT High Time (min)	$0.5 T_{CLCL} - 8$		$0.5 T_{CLCL} - 7$		ns	1.5V
T_{CH1CH2}	CLKOUT Rise Time		10		10	ns	1.0 to 3.5V
T_{CL2CL1}	CLKOUT Fall Time		10		10	ns	3.5 to 1.0V

NOTE:

- These values are supplied for design purposes.
- T_{CLCK} and T_{CHCK} (CLKIN Low and High times) should not have a duration less than 45% of T_{CKIN} .

WAVEFORMS (Continued)

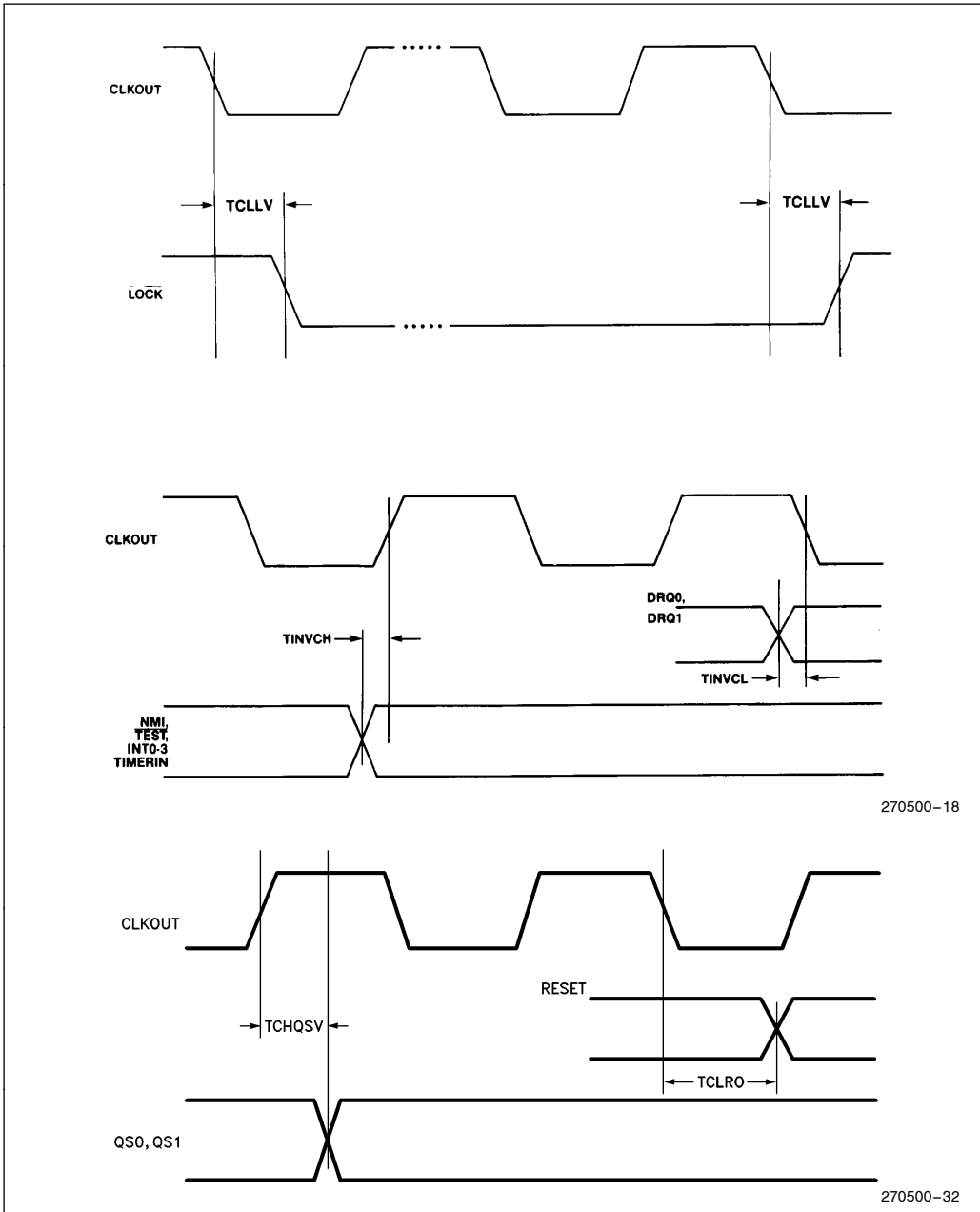

WAVEFORMS (Continued)

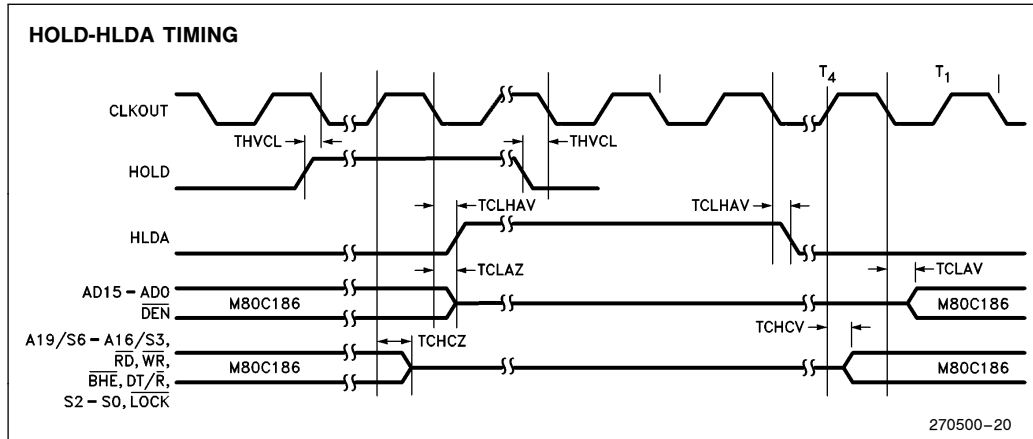
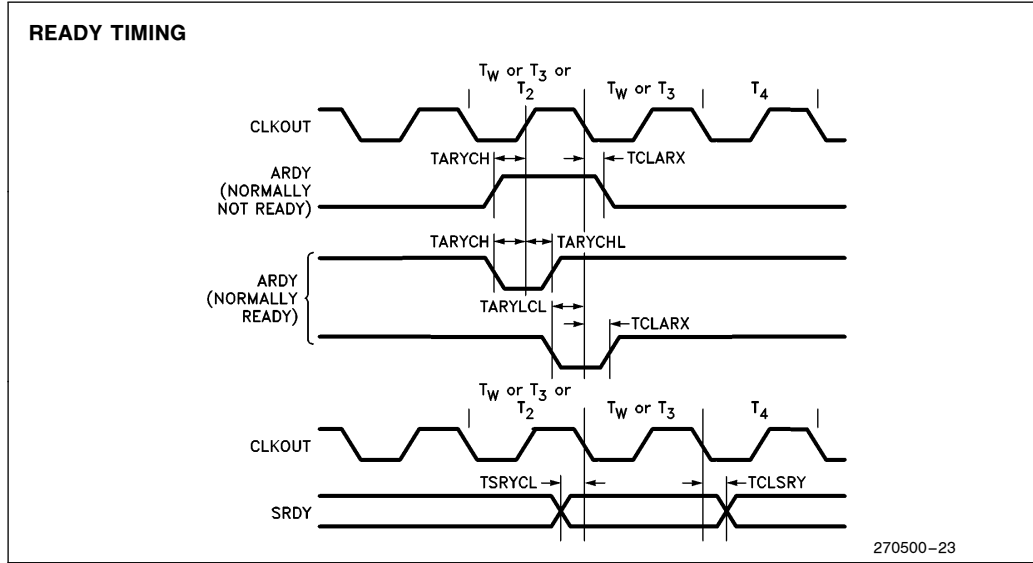

WAVEFORMS (Continued)

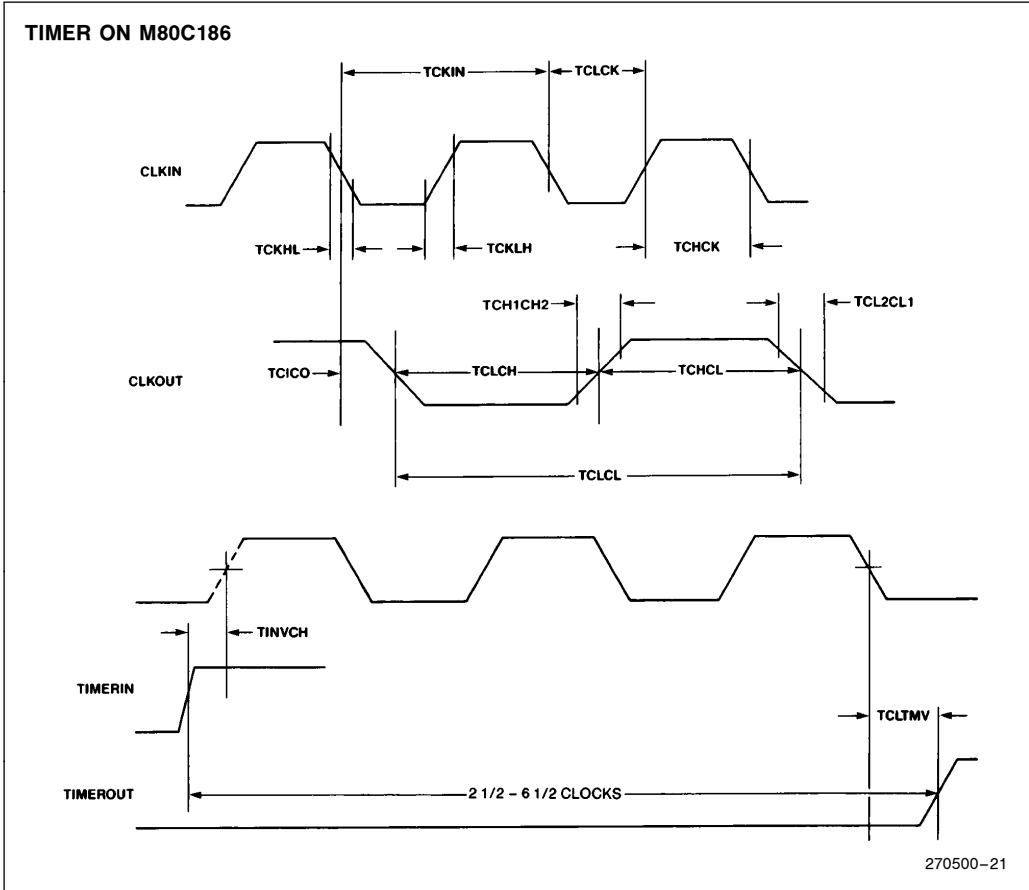

WAVEFORMS (Continued)

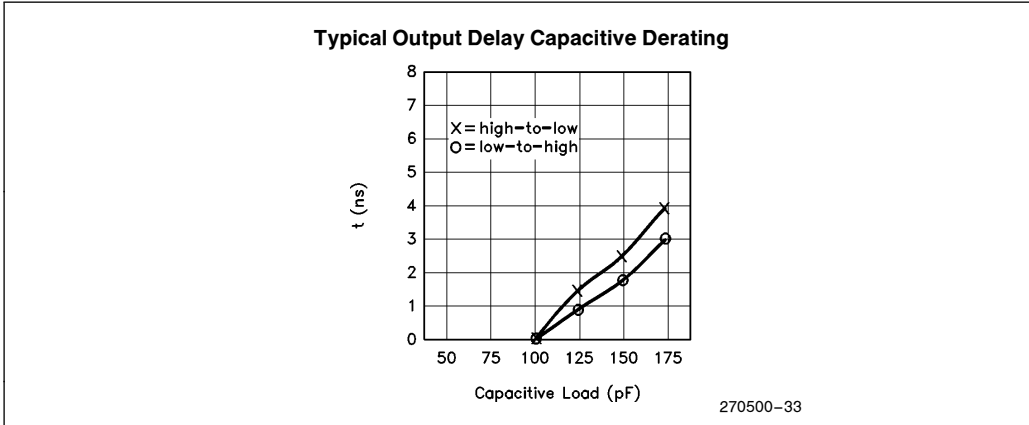

Figure 45. Capacitive Derating Curve

M80C186 EXECUTION TIMINGS

A determination of M80C186 program execution timing must consider both the bus cycles necessary to prefetch instructions as well as the number of execution unit cycles necessary to execute instructions. The following instruction timings represent the minimum execution time in clock cycles for each instruction. The timings given are based on the following assumptions:

- The opcode, along with any data or displacement required for execution of a particular instruction, has been prefetched and resides in the queue at the time it is needed.
- No wait states or bus HOLDs occur.
- All word-data is located on even-address boundaries.

All jumps and calls include the time required to fetch the opcode of the next instruction at the destination address.

All instructions which involve memory accesses can require one or two additional clocks above the minimum timings shown due to the asynchronous handshake between the BIU and execution unit.

With a 16-bit BIU, the M80C186 has sufficient bus performance to ensure that an adequate number of prefetched bytes will reside in the queue most of the time. Therefore, actual program execution will not be substantially greater than that derived from adding the instruction timings shown.



INSTRUCTION SET SUMMARY

Function	Format	Clock Cycles	Comments
DATA TRANSFER			
MOV = Move:			
Register to Register/Memory	1 0 0 0 1 0 0 w mod reg r/m	2/12	
Register/memory to register	1 0 0 0 1 0 1 w mod reg r/m	2/9	
Immediate to register/memory	1 1 0 0 0 1 1 w mod 000 r/m data data if w = 1	12–13	8/16-bit
Immediate to register	1 0 1 1 w reg data data if w = 1	3–4	8/16-bit
Memory to accumulator	1 0 1 0 0 0 0 w addr-low addr-high	8	
Accumulator to memory	1 0 1 0 0 0 1 w addr-low addr-high	9	
Register/memory to segment register	1 0 0 0 1 1 1 0 mod 0 reg r/m	2/9	
Segment register to register/memory	1 0 0 0 1 1 0 0 mod 0 reg r/m	2/11	
PUSH = Push:			
Memory	1 1 1 1 1 1 1 1 mod 1 1 0 r/m	16	
Register	0 1 0 1 0 reg	10	
Segment register	0 0 0 reg 1 1 0	9	
Immediate	0 1 1 0 1 0 s 0 data data if s = 0	10	
PUSHA = Push All	0 1 1 0 0 0 0 0	36	
POP = Pop:			
Memory	1 0 0 0 1 1 1 1 mod 0 0 0 r/m	20	
Register	0 1 0 1 1 reg	10	
Segment register	0 0 0 reg 1 1 1 (reg≠01)	8	
POPA = Pop All	0 1 1 0 0 0 0 1	51	
XCHG = Exchange:			
Register/memory with register	1 0 0 0 0 1 1 w mod reg r/m	4/17	
Register with accumulator	1 0 0 1 0 reg	3	
IN = Input from:			
Fixed port	1 1 1 0 0 1 0 w port	10	
Variable port	1 1 1 0 1 1 0 w	8	
OUT = Output to:			
Fixed port	1 1 1 0 0 1 1 w port	9	
Variable port	1 1 1 0 1 1 1 w	7	
XLAT = Translate byte to AL	1 1 0 1 0 1 1 1	11	
LEA = Load EA to register	1 0 0 0 1 1 0 1 mod reg r/m	6	
LDS = Load pointer to DS	1 1 0 0 0 1 0 1 mod reg r/m	18	(mod≠11)
LES = Load pointer to ES	1 1 0 0 0 1 0 0 mod reg r/m	18	(mod≠11)
LAHF = Load AH with flags	1 0 0 1 1 1 1 1	2	
SAHF = Store AH into flags	1 0 0 1 1 1 1 0	3	
PUSHF = Push flags	1 0 0 1 1 1 0 0	9	
POPF = Pop flags	1 0 0 1 1 1 0 1	8	

Shaded areas indicate instructions not available in M8086, M8088 microsystems.

INSTRUCTION SET SUMMARY (Continued)

Function	Format	Clock Cycles	Comments
DATA TRANSFER (Continued)			
SEGMENT = Segment Override:			
CS	0 0 1 0 1 1 1 0	2	
SS	0 0 1 1 0 1 1 0	2	
DS	0 0 1 1 1 1 1 0	2	
ES	0 0 1 0 0 1 1 0	2	
ARITHMETIC			
ADD = Add:			
Reg/memory with register to either	0 0 0 0 0 d w mod reg r/m	3/10	
Immediate to register/memory	1 0 0 0 0 s w mod 0 0 0 r/m data data if s w = 01	4/16	
Immediate to accumulator	0 0 0 0 0 1 0 w data data if w = 1	3/4	8/16-bit
ADC = Add with carry:			
Reg/memory with register to either	0 0 0 1 0 d w mod reg r/m	3/10	
Immediate to register/memory	1 0 0 0 0 s w mod 0 1 0 r/m data data if s w = 01	4/16	
Immediate to accumulator	0 0 0 1 0 1 0 w data data if w = 1	3/4	8/16-bit
INC = Increment:			
Register/memory	1 1 1 1 1 1 1 w mod 0 0 0 r/m	3/15	
Register	0 1 0 0 0 reg	3	
SUB = Subtract:			
Reg/memory and register to either	0 0 1 0 1 0 d w mod reg r/m	3/10	
Immediate from register/memory	1 0 0 0 0 s w mod 1 0 1 r/m data data if s w = 01	4/16	
Immediate from accumulator	0 0 1 0 1 1 0 w data data if w = 1	3/4	8/16-bit
SBB = Subtract with borrow:			
Reg/memory and register to either	0 0 0 1 1 0 d w mod reg r/m	3/10	
Immediate from register/memory	1 0 0 0 0 s w mod 0 1 1 r/m data data if s w = 01	4/16	
Immediate from accumulator	0 0 0 1 1 1 0 w data data if w = 1	3/4	8/16-bit
DEC = Decrement			
Register/memory	1 1 1 1 1 1 1 w mod 0 0 1 r/m	3/15	
Register	0 1 0 0 1 reg	3	
CMP = Compare:			
Register/memory with register	0 0 1 1 1 0 1 w mod reg r/m	3/10	
Register with register/memory	0 0 1 1 1 0 0 w mod reg r/m	3/10	
Immediate with register/memory	1 0 0 0 0 s w mod 1 1 1 r/m data data if s w = 01	3/10	
Immediate with accumulator	0 0 1 1 1 1 0 w data data if w = 1	3/4	8/16-bit
NEG = Change sign register/memory	1 1 1 1 0 1 1 w mod 0 1 1 r/m	3/10	
AAA = ASCII adjust for add	0 0 1 1 0 1 1 1	8	
DAA = Decimal adjust for add	0 0 1 0 0 1 1 1	4	
AAS = ASCII adjust for subtract	0 0 1 1 1 1 1 1	7	
DAS = Decimal adjust for subtract	0 0 1 0 1 1 1 1	4	
MUL = Multiply (unsigned):	1 1 1 1 0 1 1 w mod 1 0 0 r/m		
Register-Byte		26-28	
Register-Word		35-37	
Memory-Byte		32-34	
Memory-Word		41-43	

Shaded areas indicate instructions not available in M8086, M8088 microsystems.

INSTRUCTION SET SUMMARY (Continued)

Function	Format	Clock Cycles	Comments
ARITHMETIC (Continued)			
IMUL = Integer multiply (signed):	1 1 1 1 0 1 1 w mod 1 0 1 r/m		
Register-Byte		25–28	
Register-Word		34–37	
Memory-Byte		31–34	
Memory-Word		40–43	
IMUL = Integer Immediate multiply (signed)	0 1 1 0 1 0 s 1 mod reg r/m data data if s=0	22–25/ 29–32	
DIV = Divide (unsigned):	1 1 1 1 0 1 1 w mod 1 1 0 r/m		
Register-Byte		29	
Register-Word		38	
Memory-Byte		35	
Memory-Word		44	
IDIV = Integer divide (signed):	1 1 1 1 0 1 1 w mod 1 1 1 r/m		
Register-Byte		44–52	
Register-Word		53–61	
Memory-Byte		50–58	
Memory-Word		59–67	
AAM = ASCII adjust for multiply	1 1 0 1 0 1 0 0 0 0 0 0 1 0 1 0	19	
AAD = ASCII adjust for divide	1 1 0 1 0 1 0 1 0 0 0 0 1 0 1 0	15	
CBW = Convert byte to word	1 0 0 1 1 0 0 0	2	
CWD = Convert word to double word	1 0 0 1 1 0 0 1	4	
LOGIC			
Shift/Rotate Instructions:			
Register/Memory by 1	1 1 0 1 0 0 0 w mod TTT r/m	2/15	
Register/Memory by CL	1 1 0 1 0 0 1 w mod TTT r/m	5 + n/17 + n	
Register/Memory by Count	1 1 0 0 0 0 0 w mod TTT r/m count	5 + n/17 + n	
TTT Instruction 0 0 0 ROL 0 0 1 ROR 0 1 0 RCL 0 1 1 RCR 1 0 0 SHL/SAL 1 0 1 SHR 1 1 1 SAR			
AND = And:			
Reg/memory and register to either	0 0 1 0 0 0 d w mod reg r/m	3/10	
Immediate to register/memory	1 0 0 0 0 0 0 w mod 1 0 0 r/m data data if w=1	4/16	
Immediate to accumulator	0 0 1 0 0 1 0 w data data if w=1	3/4	8/16-bit
TEST = And function to flags, no result:			
Register/memory and register	1 0 0 0 0 1 0 w mod reg r/m	3/10	
Immediate data and register/memory	1 1 1 1 0 1 1 w mod 0 0 0 r/m data data if w=1	4/10	
Immediate data and accumulator	1 0 1 0 1 0 0 w data data if w=1	3/4	8/16-bit
OR = Or:			
Reg/memory and register to either	0 0 0 0 1 0 d w mod reg r/m	3/10	
Immediate to register/memory	1 0 0 0 0 0 0 w mod 0 0 1 r/m data data if w=1	4/16	
Immediate to accumulator	0 0 0 0 1 1 0 w data data if w=1	3/4	8/16-bit

Shaded areas indicate instructions not available in M8086, M8088 microsystems.

INSTRUCTION SET SUMMARY (Continued)

Function	Format	Clock Cycles	Comments
LOGIC (Continued)			
XOR = Exclusive or:			
Reg/memory and register to either	0 0 1 1 0 0 d w mod reg r/m	3/10	
Immediate to register/memory	1 0 0 0 0 0 0 w mod 1 1 0 r/m data data if w = 1	4/16	
Immediate to accumulator	0 0 1 1 0 1 0 w data data if w = 1	3/4	8/16-bit
NOT = Invert register/memory	1 1 1 1 0 1 1 w mod 0 1 0 r/m	3/10	
STRING MANIPULATION			
MOVS = Move byte/word	1 0 1 0 0 1 0 w	14	
CMPS = Compare byte/word	1 0 1 0 0 1 1 w	22	
SCAS = Scan byte/word	1 0 1 0 1 1 1 w	15	
LODS = Load byte/wd to ALAX	1 0 1 0 1 1 0 w	12	
STOS = Stor byte/wd from ALA	1 0 1 0 1 0 1 w	10	
INS = Input byte/wd from DX port	0 1 1 0 1 1 0 w	14	
OUTS = Output byte/wd to DX port	0 1 1 0 1 1 1 w	14	
Repeated by count in CX			
MOVS = Move string	1 1 1 1 0 0 1 0 1 0 1 0 0 1 0 w	8 + 8n	
CMPS = Compare string	1 1 1 1 0 0 1 z 1 0 1 0 0 1 1 w	5 + 22n	
SCAS = Scan string	1 1 1 1 0 0 1 z 1 0 1 0 1 1 1 w	5 + 15n	
LODS = Load string	1 1 1 1 0 0 1 0 1 0 1 0 1 1 0 w	6 + 11n	
STOS = Store string	1 1 1 1 0 0 1 0 1 0 1 0 1 0 1 w	6 + 9n	
INS = Input string	1 1 1 1 0 0 1 0 0 1 1 0 1 1 0 w	8 + 8n	
OUTS = Output string	1 1 1 1 0 0 1 0 0 1 1 0 1 1 1 w	8 + 8n	
CONTROL TRANSFER			
CALL = Call:			
Direct within segment	1 1 1 0 1 0 0 0 disp-low disp-high	15	
Register/memory indirect within segment	1 1 1 1 1 1 1 1 mod 0 1 0 r/m	13/19	
Direct intersegment	1 0 0 1 1 0 1 0 segment offset segment selector	23	
Indirect intersegment	1 1 1 1 1 1 1 1 mod 0 1 1 r/m (mod ≠ 11)	38	
JMP = Unconditional jump:			
Short/long	1 1 1 0 1 0 1 1 disp-low	14	
Direct within segment	1 1 1 0 1 0 0 1 disp-low disp-high	14	
Register/memory indirect within segment	1 1 1 1 1 1 1 1 mod 1 0 0 r/m	11/17	
Direct intersegment	1 1 1 0 1 0 1 0 segment offset segment selector	14	
Indirect intersegment	1 1 1 1 1 1 1 1 mod 1 0 1 r/m (mod ≠ 11)	26	

Shaded areas indicate instructions not available in M8086, M8088 microsystems.

INSTRUCTION SET SUMMARY (Continued)

Function	Format	Clock Cycles	Comments
CONTROL TRANSFER (Continued)			
RET = Return from CALL:			
Within segment	1 1 0 0 0 0 1 1	16	
Within seg adding immed to SP	1 1 0 0 0 0 1 0 data-low data-high	18	
Intersegment	1 1 0 0 1 0 1 1	22	
Intersegment adding immediate to SP	1 1 0 0 1 0 1 0 data-low data-high	25	
JE/JZ = Jump on equal/zero	0 1 1 1 0 1 0 0 disp	4/13	JMP not taken/JMP taken
JL/JNGE = Jump on less/not greater or equal	0 1 1 1 1 1 0 0 disp	4/13	
JLE/JNG = Jump on less or equal/not greater	0 1 1 1 1 1 1 0 disp	4/13	
JB/JNAE = Jump on below/not above or equal	0 1 1 1 0 0 1 0 disp	4/13	
JBE/JNA = Jump on below or equal/not above	0 1 1 1 0 1 1 0 disp	4/13	
JP/JPE = Jump on parity/parity even	0 1 1 1 1 0 1 0 disp	4/13	
JO = Jump on overflow	0 1 1 1 0 0 0 0 disp	4/13	
JS = Jump on sign	0 1 1 1 1 0 0 0 disp	4/13	
JNE/JNZ = Jump on not equal/not zero	0 1 1 1 0 1 0 1 disp	4/13	
JNL/JGE = Jump on not less/greater or equal	0 1 1 1 1 1 0 1 disp	4/13	
JNLE/JG = Jump on not less or equal/greater	0 1 1 1 1 1 1 1 disp	4/13	
JNB/JAE = Jump on not below/above or equal	0 1 1 1 0 0 1 1 disp	4/13	
JNBE/JA = Jump on not below or equal/above	0 1 1 1 0 1 1 1 disp	4/13	
JNP/JPO = Jump on not par/par odd	0 1 1 1 1 0 1 1 disp	4/13	
JNO = Jump on not overflow	0 1 1 1 0 0 0 1 disp	4/13	
JNS = Jump on not sign	0 1 1 1 1 0 0 1 disp	4/13	
JCXZ = Jump on CX zero	1 1 1 0 0 0 1 1 disp	5/15	
LOOP = Loop CX times	1 1 1 0 0 0 1 0 disp	6/16	
LOOPZ/LOOPE = Loop while zero/equal	1 1 1 0 0 0 0 1 disp	6/16	
LOOPNZ/LOOPNE = Loop while not zero/equal	1 1 1 0 0 0 0 0 disp	6/16	
ENTER = Enter Procedure	1 1 0 0 1 0 0 0 data-low data-high L	15 25 22 + 16(n - 1)	
L = 0			
L = 1			
L > 1			
LEAVE = Leave Procedure	1 1 0 0 1 0 0 1	8	
INT = Interrupt:			
Type specified	1 1 0 0 1 1 0 1 type	47	if INT. taken/ if INT. not taken
Type 3	1 1 0 0 1 1 0 0	45	
INTO = Interrupt on overflow	1 1 0 0 1 1 1 0	48/4	
IRET = Interrupt return	1 1 0 0 1 1 1 1	28	
BOUND = Detect value out of range	0 1 1 0 0 0 1 0 mod reg r/m	33-35	

Shaded areas indicate instructions not available in M8086, M8088 microsystems.

INSTRUCTION SET SUMMARY (Continued)

Function	Format	Clock Cycles	Comments
PROCESSOR CONTROL			
CLC = Clear carry	1 1 1 1 1 0 0 0	2	
CMC = Complement carry	1 1 1 1 0 1 0 1	2	
STC = Set carry	1 1 1 1 1 0 0 1	2	
CLD = Clear direction	1 1 1 1 1 1 0 0	2	
STD = Set direction	1 1 1 1 1 1 0 1	2	
CLI = Clear interrupt	1 1 1 1 1 0 1 0	2	
STI = Set interrupt	1 1 1 1 1 0 1 1	2	
HLT = Halt	1 1 1 1 0 1 0 0	2	
WAIT = Wait	1 0 0 1 1 0 1 1	6	if $\overline{\text{test}} = 0$
LOCK = Bus lock prefix	1 1 1 1 0 0 0 0	2	
ESC = Processor Extension Escape	1 1 0 1 1 T T T mod LLL r/m	6	

(TTT LLL are opcode to processor extension)

Shaded areas indicate instructions not available in M8086, M8088 microsystems.

FOOTNOTES

The Effective Address (EA) of the memory operand is computed according to the mod and r/m fields:

- if mod = 11 then r/m is treated as a REG field
- if mod = 00 then DISP = 0*, disp-low and disp-high are absent
- if mod = 01 then DISP = disp-low sign-extended to 16-bits, disp-high is absent
- if mod = 10 then DISP = disp-high: disp-low
- if r/m = 000 then EA = (BX) + (SI) + DISP
- if r/m = 001 then EA = (BX) + (DI) + DISP
- if r/m = 010 then EA = (BP) + (SI) + DISP
- if r/m = 011 then EA = (BP) + (DI) + DISP
- if r/m = 100 then EA = (SI) + DISP
- if r/m = 101 then EA = (DI) + DISP
- if r/m = 110 then EA = (BP) + DISP*
- if r/m = 111 then EA = (BX) + DISP

DISP follows 2nd byte of instruction (before data if required)

*except if mod = 00 and r/m = 110 then EA = disp-high: disp-low.

EA calculation time is 4 clock cycles for all modes, and is included in the execution times given whenever appropriate.

Segment Override Prefix

0	0	1	reg	1	1	0
---	---	---	-----	---	---	---

reg is assigned according to the following:

reg	Segment Register
00	ES
01	CS
10	SS
11	DS

REG is assigned according to the following table:

16-Bit (w = 1)	8-Bit (w = 0)
000 AX	000 AL
001 CX	001 CL
010 DX	010 DL
011 BX	011 BL
100 SP	100 AH
101 BP	101 CH
110 SI	110 DH
111 DI	111 BH

The physical addresses of all operands addressed by the BP register are computed using the SS segment register. The physical addresses of the destination operands of the string primitive operations (those addressed by the DI register) are computed using the ES segment, which may not be overridden.