

M/A-COM 3.6V 0.5W RF Power Amplifier IC for DECT

FEATURES

- Single Positive Supply
- 57% Power Added Efficiency
- Operation down to 1.2 V
- 100% Duty Cycle
- 1800 to 2000 MHz Operation
- 8 Pin Full Downset MSOP Plastic Package
- Accommodates Battery Charging Conditions up to 5.6 Volts
- Self-Aligned MSAG®-Lite MESFET Process

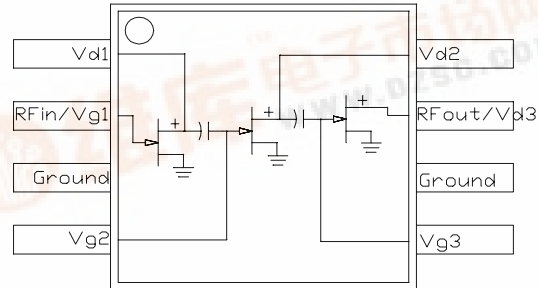

8 Lead MSOP Package

Package bottom is electrical and thermal ground

DESCRIPTION

The MA02206GJ is a DECT Power amplifier based on M/A-COM's Self-Aligned MSAG MESFET Process. This product is designed for use in 3.6 V DECT handsets and base stations.

MAXIMUM RATINGS (Beyond these limits, the device may be damaged or device reliability reduced. Functional operation at absolute-maximum-rated conditions is not implied.)

Rating	Symbol	Value	Unit
DC Supply Voltage	V_{DD}	6.0	V
RF Input Power	P_{IN}	10	mW
Junction Temperature	T_J	150	°C
Storage Temperature Range	T_{STG}	-40 to +150	°C
Operating Temperature Range	T_{OPER}	-40 to +100	°C
Moisture Sensitivity		JEDEC Level 1	

ELECTRICAL CHARACTERISTICS $V_{DD} = +3.6$ V, $P_{IN} = -2$ dBm, Duty Cycle = 100 %, $T_s = 37$ °C (Note 1), measured on evaluation board shown in Figure 9.

Characteristic	Symbol	Min	Typ	Max	Unit
Frequency Range	f	1880	1900	1930	MHz
Output Power (1900 MHz)	P_{OUT}	25.9	26.9	27.9	dBm
Power Added Efficiency (1900 MHz)	η	52	57		%
Drain Current (1900MHz)	I_{DD}		228	330	mA
Harmonics	$2f_o$ $3f_o$		-37 -38	-30 -34	dBc
Input VSWR	—		1.3:1	2.0:1	—
Off Isolation ($V_{DD}=0$ V)	—	38	44		dB
Thermal Resistance, Junction to soldering point (T_s) (Note 1)	—		25		°C/W
Load Mismatch ($V_{DD} = 4.5$ V, VSWR = 5:1, $P_{IN} = -2$ dBm)	—	No Degradation in Power Output			
Stability ($P_{IN} = -2$ to 2 dBm, $V_{DD} = 0-5.0$ V, Load VSWR = 5:1, all phases)	—	All non-harmonically related outputs more than 60 dB below desired signal			

Note 1: T_s is the temperature measured at the soldering point of the downset paddle on the bottom of the IC.

Note 2: Output power and efficiency have been optimized for input drive levels between -2 to +2 dBm. Stability is only specified within this range. For operation outside of this range, contact the factory.

Specifications subject to change without notice.

902407 E

North America: Tel. (800)366-2266, Fax (800)618-8883
 Asia/Pacific: Tel. +81-44-844-8296, Fax +81-44-844-8298
 Europe: Tel. +44 (1344) 869 595, Fax +44 (1344) 300 020

Visit www.macom.com for additional data sheets and product information

TYPICAL CHARACTERISTICS (Measured data from process nominal devices)

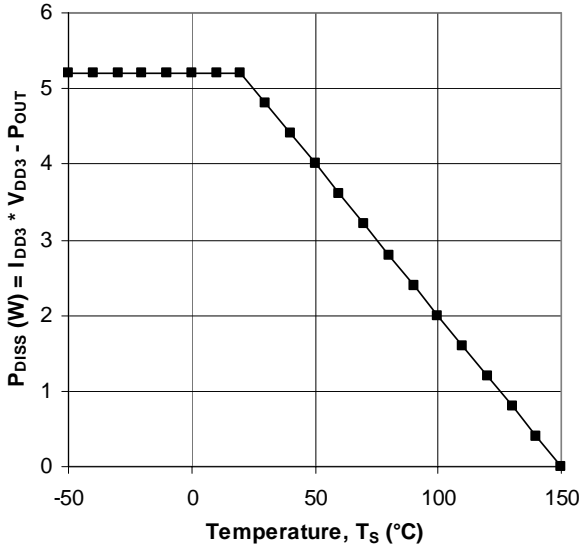

Figure 1. Maximum operating temperature (T_S) to maintain $<150^\circ\text{C}$ junction temperature.

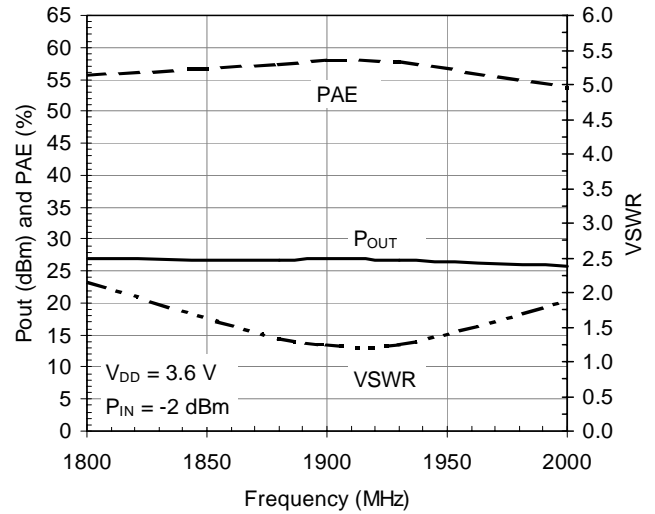

Figure 2. Output power, power added efficiency, and input VSWR vs. frequency

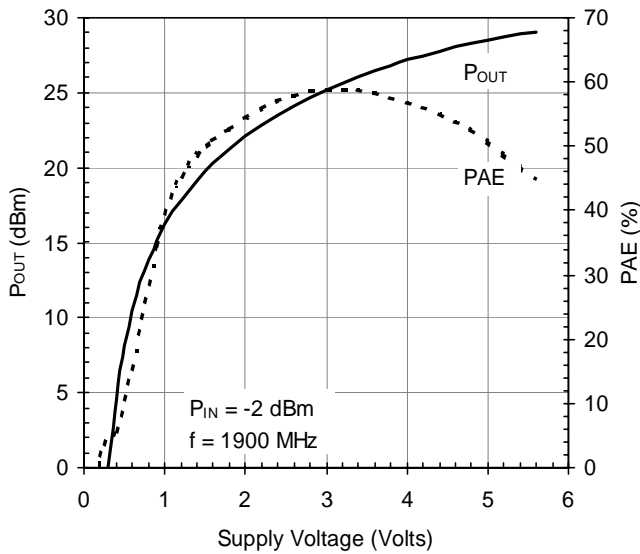

Figure 3. Output power and power added efficiency vs. supply voltage

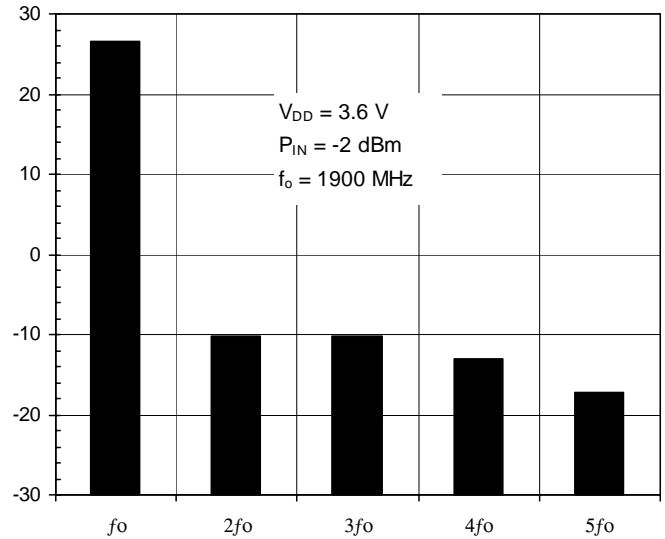

Figure 4. Harmonics

Specifications subject to change without notice.

■ North America: Tel. (800)366-2266, Fax (800)618-8883
 ■ Asia/Pacific: Tel. +81-44-844-8296, Fax +81-44-844-8298
 ■ Europe: Tel. +44 (1344) 869 595, Fax +44 (1344) 300 020

902407 E

TYPICAL CHARACTERISTICS (Measured data from process nominal devices)

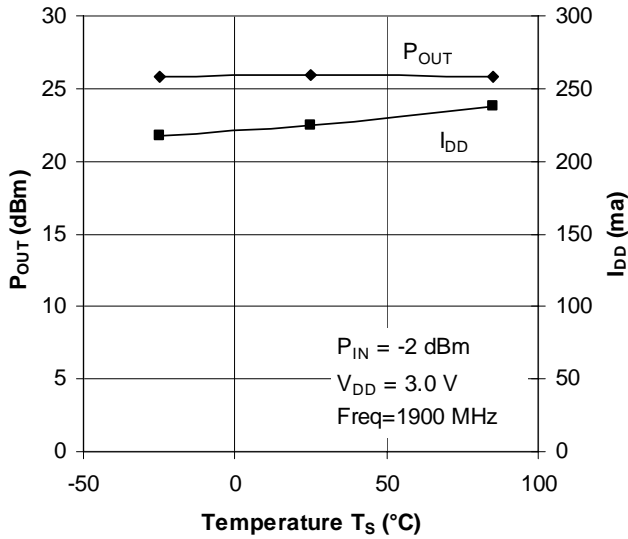

Figure 5. Output power and drain current vs. temperature at $V_{DD}=+3.0V$

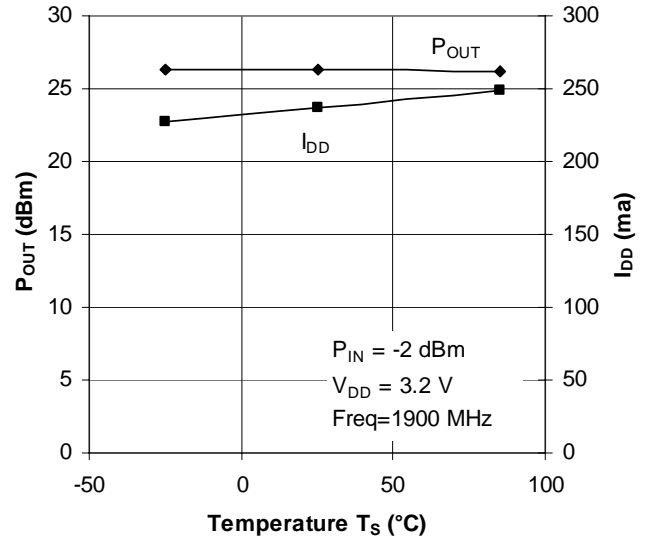

Figure 6. Output power and drain current vs. temperature at $V_{DD}=+3.2V$

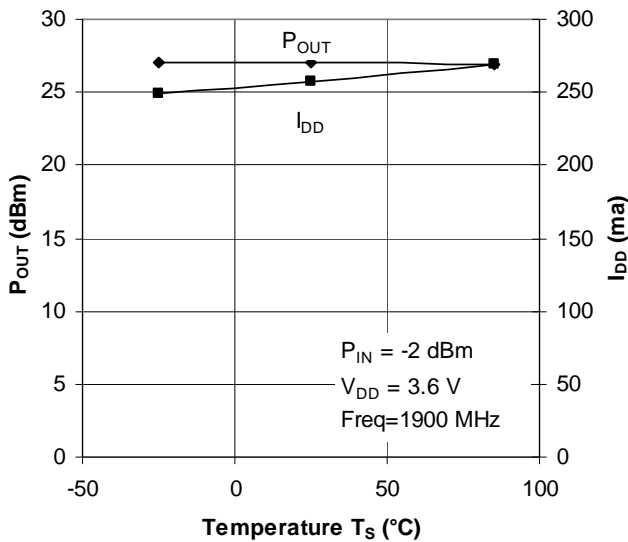

Figure 7. Output power and drain current vs. temperature at $V_{DD}=+3.6V$

Specifications subject to change without notice.

■ North America: Tel. (800)366-2266, Fax (800)618-8883
 ■ Asia/Pacific: Tel. +81-44-844-8296, Fax +81-44-844-8298
 ■ Europe: Tel. +44 (1344) 869 595, Fax +44 (1344) 300 020

902407 E

APPLICATION INFORMATION

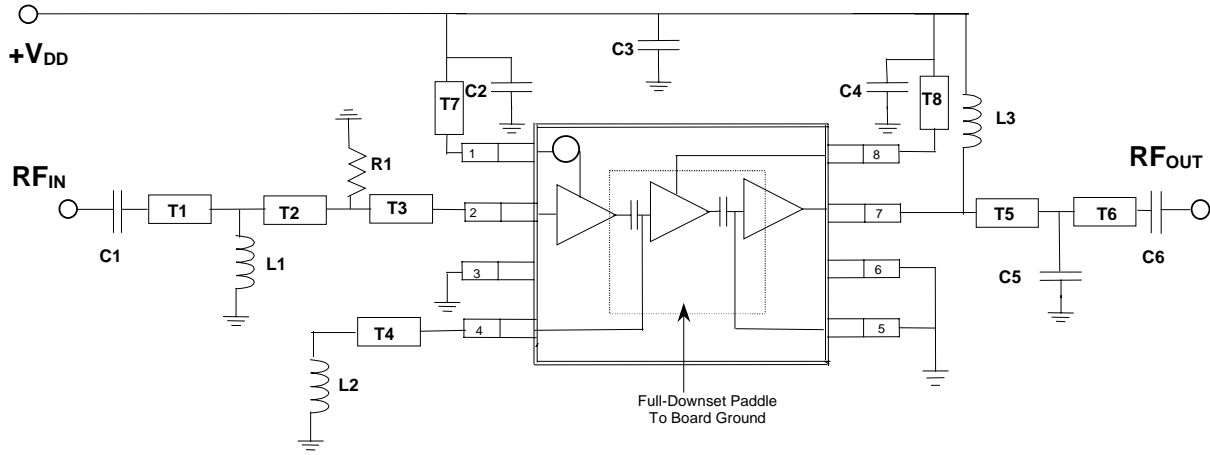

Figure 8. Evaluation Board Schematic

List of components:

- C1 = 0.7 pF multilayer ceramic chip capacitor
 - C2 = C3 = C4 = C6 = 100 pF multilayer ceramic chip capacitor
 - C5 = 2.2 pF multilayer ceramic chip capacitor
 - L1 = 2.7 nH chip inductor
 - L2 = 3.3 nH chip inductor
 - L3 = 27 nH chip inductor
 - R1 = 300 Ω chip resistor
- 60 mil GETEK Board

Transmission Lines (Grounded Coplanar Waveguide)

- T1 = 0.140" 50 Ω
- T2 = 0.110" 50 Ω
- T3 = 0.100" 50 Ω
- T4 = 0.400" 75 Ω
- T5 = 0.195" 50 Ω
- T6 = 0.280" 50 Ω
- T7=78 = 0.090" 75 Ω

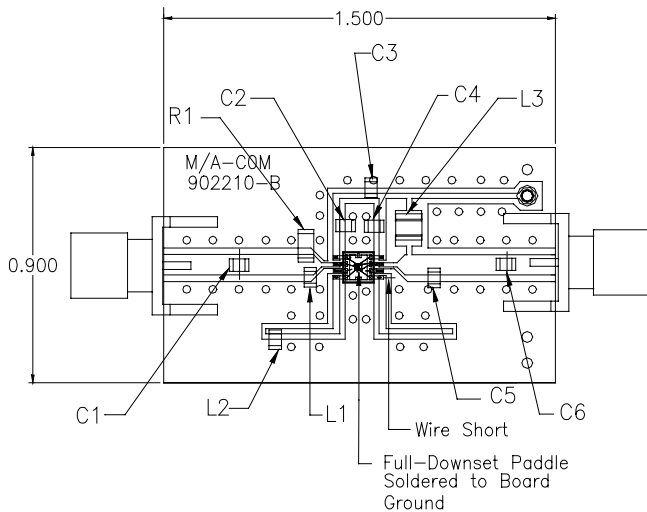
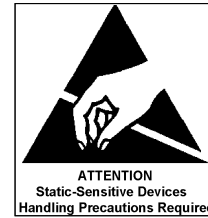

Figure 9. Evaluation Board Layout

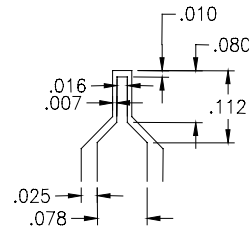

Figure 10. 50 Ω Lead Transition

Specifications subject to change without notice.

- North America: Tel. (800)366-2266, Fax (800)618-8883
- Asia/Pacific: Tel. +81-44-844-8296, Fax +81-44-844-8298
- Europe: Tel. +44 (1344) 869 595, Fax +44 (1344) 300 020

902407 E

DESIGNING WITH THE MA02206GJ

The MA02206GJ is built using a near-enhancement mode FET that operates from a single supply voltage. A negative voltage is not required because the FET is designed to operate with a +0V DC gate bias.

There is no impedance matching or RF choking on this IC – these functions are supplied externally. This approach offers the highest level of performance, the lowest bill of materials cost, and far fewer components than a discrete design.

Output power and efficiency have been optimized for DECT conditions. Input power must be kept between –2 and +2dBm.

To duplicate MA02206GJ data sheet performance, your circuit board must recreate the same impedances developed on this evaluation board. The table below has one-port s-parameter measurements looking into the traces on the evaluation board. S-parameters of the MA02206GJ are not supplied because the device is designed to operate under large-signal conditions.

Freq GHz	V _{DD1} Mag	Pin 1 Ang	RF _{IN} /V _{GG1} Mag	Pin 2 Ang	V _{GG2} Mag	Pin 4 Ang	RF _{OUT} /V _{DD3} Mag	Pin 7 Ang	V _{DD2} Mag	Pin 8 Ang
0.2	0.98045	178.38	0.15583	92.45	0.98634	159.96	0.53341	119.98	0.99255	178.98
0.3	0.94299	158.86	0.34874	-79.64	0.99012	150.97	0.32398	106.05	0.97095	163.41
0.4	0.97932	-171.16	0.61727	89.09	0.98896	141.89	0.20397	98.78	0.98118	-178.46
0.5	0.98910	-178.37	0.53105	68.98	0.98414	132.81	0.10550	90.87	0.98448	-176.22
0.6	0.99498	177.21	0.81116	49.51	0.98671	124.13	0.01912	95.87	0.99955	176.46
0.7	0.99236	174.45	0.87096	32.24	0.98308	115.73	0.05548	-108.06	0.99916	173.24
0.8	0.99399	172.25	0.84304	20.09	0.98482	107.57	0.12170	-111.09	1.00072	170.74
0.9	0.99541	170.17	0.86887	16.78	0.98514	99.90	0.18593	-116.17	1.00140	168.47
1.0	0.99503	168.20	0.87209	9.18	0.98562	92.35	0.24519	-121.18	1.00119	166.28
1.1	0.99279	166.32	0.87044	1.42	0.97997	85.32	0.30304	-126.47	0.99926	164.20
1.2	0.99285	164.31	0.83274	-4.47	0.98220	78.49	0.35920	-131.80	0.99991	161.99
1.3	0.99423	162.46	0.80852	-11.26	0.98249	72.12	0.41315	-137.20	0.99956	159.92
1.4	0.98574	159.89	0.74573	-16.03	0.98284	65.97	0.46330	-142.60	0.99277	157.02
1.5	0.88116	157.23	0.66751	-21.70	0.97828	60.11	0.51088	-148.03	0.86762	154.31
1.6	0.97552	161.35	0.60211	-24.92	0.98255	54.23	0.55789	-153.43	0.98555	158.39
1.7	0.98767	158.42	0.53753	-28.44	0.98167	48.79	0.59900	-158.95	0.99642	155.25
1.8	0.99039	156.35	0.45804	-27.44	0.98173	43.48	0.63867	-164.21	0.99918	152.78
1.9	0.99244	154.61	0.41128	-25.54	0.98234	38.27	0.67512	-169.36	1.00119	150.69
2.0	0.98742	152.93	0.36682	-20.92	0.97956	33.43	0.70454	-174.44	0.99355	148.30
2.1	0.99010	151.31	0.34855	-16.52	0.97866	28.52	0.73360	-178.67	0.88062	147.26
2.2	0.98911	149.68	0.32313	-13.38	0.97966	23.87	0.76239	175.86	0.99684	146.97
2.3	0.99139	148.11	0.30695	-8.01	0.98028	19.13	0.78572	171.11	1.00029	144.53
2.4	0.98809	146.33	0.30024	-0.16	0.97910	14.65	0.80560	166.68	1.00005	142.46
2.5	0.99058	144.56	0.32491	3.85	0.97652	10.29	0.82474	162.24	1.00010	140.35
2.6	0.98513	142.80	0.32429	4.54	0.97751	5.87	0.83818	157.93	0.99560	138.31
2.7	0.98991	140.66	0.31415	7.56	0.97715	1.53	0.86018	153.55	0.99891	136.04
2.8	0.97904	138.58	0.31418	14.28	0.97600	-2.68	0.87076	149.33	0.98388	133.36
2.9	0.94926	136.15	0.33349	18.76	0.97526	-7.00	0.88376	145.18	0.95012	130.27
3.0	0.90603	138.55	0.36476	23.39	0.97179	-11.28	0.89423	141.16	0.86390	133.79
3.1	0.96258	137.61	0.43170	21.35	0.96761	-15.40	0.90136	136.54	0.95789	133.92
3.2	0.97824	135.30	0.42416	18.54	0.96919	-19.53	0.90933	132.45	0.97992	130.74

Specifications subject to change without notice.

- North America: Tel. (800)366-2266, Fax (800)618-8883
- Asia/Pacific: Tel. +81-44-844-8296, Fax +81-44-844-8298
- Europe: Tel. +44 (1344) 869 595, Fax +44 (1344) 300 020

902407 E

Freq GHz	V _{DD1} Mag	Pin 1 Ang	RF _{IN} /V _{GG1} Mag	Pin 2 Ang	V _{GG2} Mag	Pin 4 Ang	RF _{OUT} /V _{DD3} Mag	Pin 7 Ang	V _{DD2} Mag	Pin 8 Ang
3.3	0.98600	133.22	0.44491	18.34	0.96815	-23.97	0.92075	128.19	0.99110	128.32
3.4	0.97581	131.03	0.46286	15.87	0.96856	-28.22	0.91634	123.51	0.98056	125.59
3.5	0.97510	128.55	0.47492	13.72	0.96669	-32.53	0.92419	117.78	0.98100	122.36
3.6	0.95375	126.87	0.48711	11.01	0.96540	-36.99	0.91573	111.37	0.95666	119.66
3.7	0.95057	127.45	0.49197	7.38	0.96407	-41.44	0.88717	101.63	0.93969	117.38
3.8	0.97376	125.97	0.48573	2.45	0.96212	-46.11	0.67487	79.43	0.80350	109.35
3.9	0.97682	123.62	0.46779	-0.28	0.96054	-50.67	0.46027	156.66	0.86651	131.73
4.0	0.98005	121.79	0.45180	-4.24	0.96034	-55.50	0.84398	132.42	0.96565	124.03
4.1	0.98137	119.83	0.42656	-7.50	0.95559	-60.49	0.91747	120.75	0.98040	119.87
4.2	0.97884	118.09	0.39991	-11.55	0.95544	-65.64	0.94120	113.77	0.98556	117.40
4.3	0.97918	116.42	0.36462	-15.55	0.95345	-70.99	0.95303	108.35	0.98601	114.89
4.4	0.97904	114.45	0.32379	-19.79	0.95303	-76.48	0.96185	103.78	0.98684	112.78
4.5	0.97991	112.45	0.27421	-24.08	0.95103	-82.34	0.96948	99.46	0.98870	110.59
4.6	0.97809	110.26	0.21778	-28.21	0.94710	-88.30	0.97059	95.22	0.98453	108.46
4.7	0.96567	108.32	0.15094	-30.95	0.94266	-94.72	0.96901	91.36	0.97623	106.45
4.8	0.96153	105.69	0.07907	-24.06	0.93632	-101.21	0.97053	87.30	0.97255	104.06
4.9	0.93877	103.67	0.03254	37.56	0.93172	-108.15	0.96542	83.54	0.94871	102.09
5.0	0.89436	102.91	0.11563	93.79	0.90196	-115.16	0.95436	79.82	0.90915	101.96
5.1	0.88960	104.77	0.17035	81.80	0.91026	-120.16	0.94874	76.13	0.92284	103.31
5.2	0.92614	104.42	0.20983	84.90	0.92716	-128.19	0.93975	72.37	0.95245	102.11
5.3	0.94661	102.27	0.26841	84.54	0.92694	-136.71	0.93430	68.62	0.96874	99.91
5.4	0.95985	100.14	0.32306	81.90	0.92817	-145.26	0.92552	64.45	0.97597	98.06
5.5	0.96135	97.63	0.36853	77.62	0.92438	-154.07	0.91055	60.10	0.97767	95.99
5.6	0.95723	95.59	0.40466	73.11	0.91805	-163.10	0.89467	55.88	0.97522	94.27
5.7	0.95195	93.78	0.43174	69.62	0.91529	-172.11	0.88144	51.26	0.97159	92.53
5.8	0.94291	92.04	0.45333	66.86	0.90561	178.78	0.86118	45.92	0.96476	91.00
5.9	0.94307	90.43	0.48474	63.83	0.91067	169.22	0.84235	39.69	0.96887	89.52
6.0	0.94249	89.05	0.50533	59.87	0.90904	159.64	0.81197	32.21	0.96766	87.98

Specifications subject to change without notice.

- North America: Tel. (800)366-2266, Fax (800)618-8883
- Asia/Pacific: Tel. +81-44-844-8296, Fax +81-44-844-8298
- Europe: Tel. +44 (1344) 869 595, Fax +44 (1344) 300 020

902407 E