

# Triacs

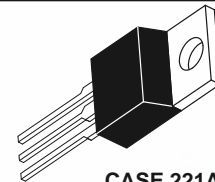
## Silicon Bidirectional Triode Thyristors

... designed primarily for full-wave ac control applications such as lighting systems, heater controls, motor controls and power supplies; or wherever full-wave silicon-gate-controlled devices are needed.

- Off-State Voltages to 800 Volts
- All Diffused and Glass-Passivated Junctions for Parameter Uniformity and Stability
- Small, Rugged, Thermowatt Construction for Thermal Resistance and High Heat Dissipation
- Gate Triggering Guaranteed in Three Modes (MAC223 Series) or Four Modes (MAC223A Series)

### MAC223 Series MAC223A Series

TRIACs  
25 AMPERES RMS  
200 thru 800 VOLTS



CASE 221A-04  
(TO-220AB)  
STYLE 4

#### MAXIMUM RATINGS ( $T_J = 25^\circ$ unless otherwise noted.)

Rating	Symbol	Value	Unit
Peak Repetitive Off-State Voltage ( $T_J = -40$ to $125^\circ\text{C}$ ) <sup>(1)</sup> (1/2 Sine Wave 50 to 60 Hz, Gate Open)	$V_{DRM}$	200 400 600 800	Volts
On-State RMS Current ( $T_C = 80^\circ\text{C}$ ) (Full Cycle Sine Wave 50 to 60 Hz)	$I_T(\text{RMS})$	25	Amps
Peak Non-repetitive Surge Current (One Full Cycle, 60 Hz, $T_C = 80^\circ\text{C}$ , preceded and followed by rated current)	$I_{TSM}$	250	Amps
Circuit Fusing ( $t = 8.3$ ms)	$I^2t$	260	$\text{A}^2\text{s}$
Peak Gate Current ( $t \leq 2 \mu\text{s}$ )	$I_{GM}$	2	Amps
Peak Gate Voltage ( $t \leq 2 \mu\text{s}$ )	$V_{GM}$	$\pm 10$	Volts
Peak Gate Power ( $t \leq 2 \mu\text{s}$ )	$P_{GM}$	20	Watts
Average Gate Power ( $T_C = 80^\circ\text{C}$ , $t \leq 8.3$ ms)	$P_{G(AV)}$	0.5	Watts
Operating Junction Temperature Range	$T_J$	-40 to 125	$^\circ\text{C}$
Storage Temperature Range	$T_{stg}$	-40 to 150	$^\circ\text{C}$
Mounting Torque	—	8	in. lb.

1.  $V_{DRM}$  for all types can be applied on a continuous basis. Blocking voltages shall not be tested with a constant current source such that the voltage ratings of the devices are exceeded.



## MAC223 Series MAC223A Series

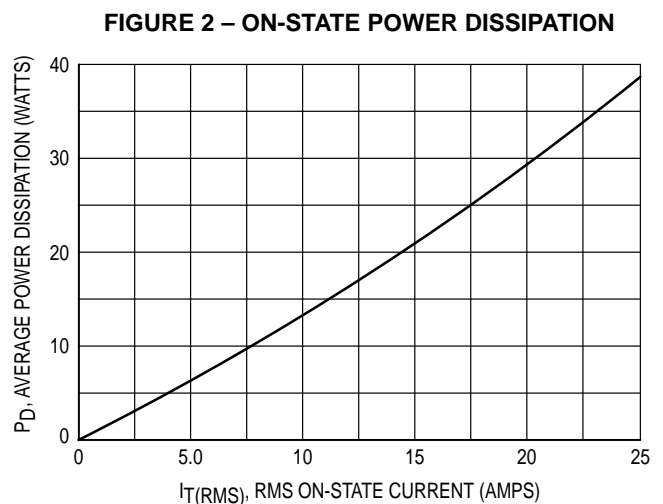
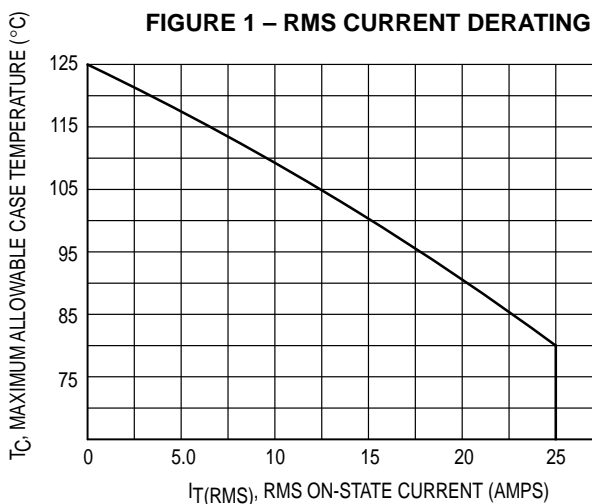
### THERMAL CHARACTERISTICS

Characteristic	Symbol	Max	Unit
Thermal Resistance, Junction to Case	$R_{\theta JC}$	1.2	$^{\circ}\text{C}/\text{W}$
Thermal Resistance, Junction to Ambient	$R_{\theta JA}$	60	$^{\circ}\text{C}/\text{W}$

### ELECTRICAL CHARACTERISTICS ( $T_C = 25^{\circ}\text{C}$ and either polarity of MT2 to MT1 voltage unless otherwise noted.)

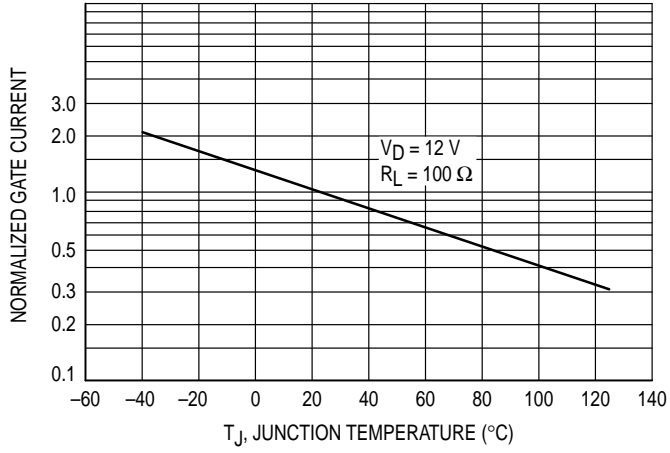
Characteristic	Symbol	Min	Typ	Max	Unit
Peak Blocking Current <sup>(1)</sup> ( $V_D = \text{Rated } V_{DRM}$ ) $T_J = 25^{\circ}\text{C}$ $T_J = 125^{\circ}\text{C}$	$I_{DRM}$	— —	— —	10 2	$\mu\text{A}$ $\text{mA}$
Peak On-State Voltage ( $I_{TM} = 35 \text{ A Peak}$ , Pulse Width $\leq 2 \text{ ms}$ , Duty Cycle $\leq 2\%$ )	$V_{TM}$	—	1.4	1.85	Volts
Gate Trigger Current (Continuous dc) ( $V_D = 12 \text{ V}$ , $R_L = 100 \Omega$ ) MT2(+), G(+); MT2(-), G(-); MT(+), G(-) MT2(-), G(+) "A" SUFFIX ONLY	$I_{GT}$	— —	20 30	50 75	$\text{mA}$
Gate Trigger Voltage (Continuous dc) ( $V_D = 12 \text{ V}$ , $R_L = 100 \Omega$ ) MT2(+), G(+); MT2(-), G(-); MT(+), G(-) MT2(-), G(+) "A" SUFFIX ONLY ( $V_D = \text{Rated } V_{DRM}$ , $T_J = 125^{\circ}\text{C}$ , $R_L = 10 \text{ k}$ ) MT(+), G(+); MT2(-), G(-); MT2(+), G(-) MT2(-), G(+) "A" SUFFIX ONLY	$V_{GT}$	— — 0.2 0.2	1.1 1.3 0.4 0.4	2 2.5 — —	Volts
Holding Current ( $V_D = 12 \text{ V}$ , $I_{TM} = 200 \text{ mA}$ , Gate Open)	$I_H$	—	10	50	$\text{mA}$
Gate Controlled Turn-On Time ( $V_D = \text{Rated } V_{DRM}$ , $I_{TM} = 35 \text{ A Peak}$ , $I_G = 200 \text{ mA}$ )	$t_{gt}$	—	1.5	—	$\mu\text{s}$
Critical Rate of Rise of Off-State Voltage ( $V_D = \text{Rated } V_{DRM}$ , Exponential Waveform, $T_C = 125^{\circ}\text{C}$ )	$dv/dt$	—	40	—	$\text{V}/\mu\text{s}$
Critical Rate of Rise of Commutation Voltage ( $V_D = \text{Rated } V_{DRM}$ , $I_{TM} = 35 \text{ A Peak}$ , Commutating $di/dt = 12.6 \text{ A/ms}$ , Gate Unenergized, $T_C = 80^{\circ}\text{C}$ )	$dv/dt(c)$	—	5	—	$\text{V}/\mu\text{s}$

1. Ratings apply for open gate conditions. Devices shall not be tested with a constant current source for blocking voltage such that the voltage applied exceeds the rated blocking voltage.

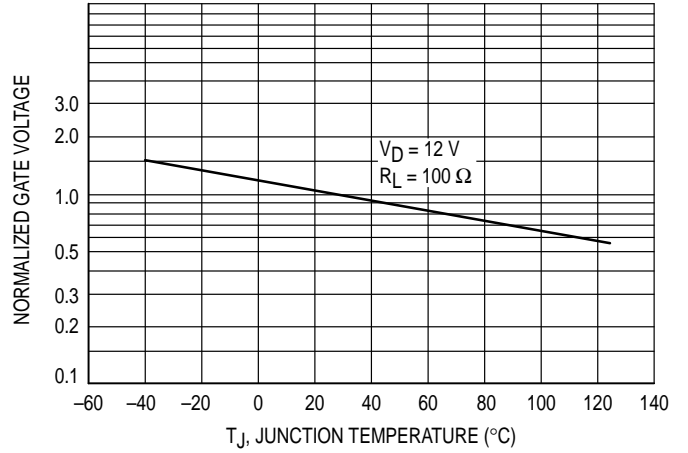


**MAC223 Series MAC223A Series**

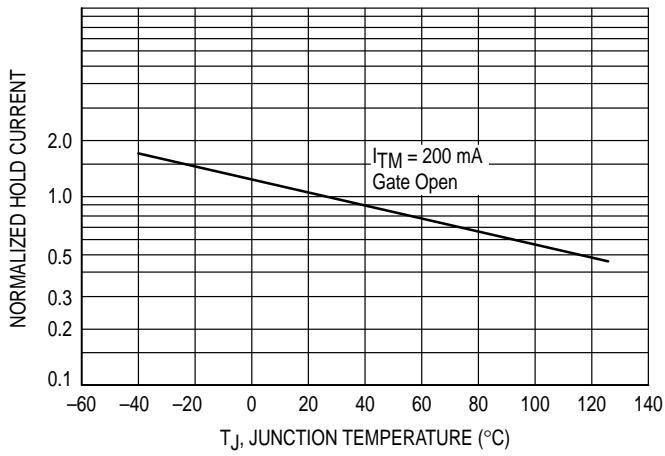
**FIGURE 3 – GATE TRIGGER CURRENT**



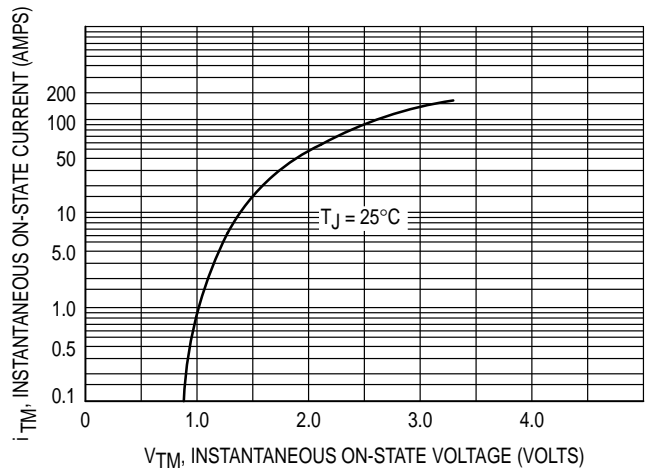
**FIGURE 4 – GATE TRIGGER VOLTAGE**



**FIGURE 5 – HOLD CURRENT**

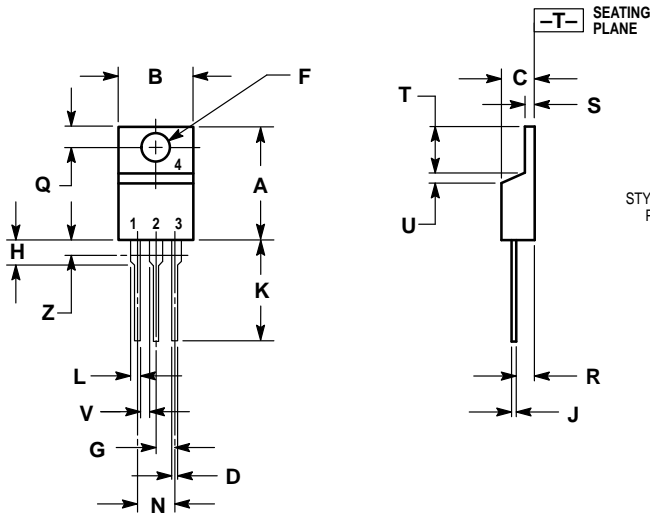


**FIGURE 6 – TYPICAL ON-STATE CHARACTERISTICS**



**MAC223 Series MAC223A Series**

**PACKAGE DIMENSIONS**




STYLE 4:  
 PIN 1. MAIN TERMINAL 1  
 2. MAIN TERMINAL 2  
 3. GATE  
 4. MAIN TERMINAL 2

- NOTES:  
 1. DIMENSIONING AND TOLERANCING PER ANSI Y14.5M, 1982.  
 2. CONTROLLING DIMENSION: INCH.  
 3. DIMENSION Z DEFINES A ZONE WHERE ALL BODY AND LEAD IRREGULARITIES ARE ALLOWED.

DIM	INCHES		MILLIMETERS	
	MIN	MAX	MIN	MAX
A	0.570	0.620	14.48	15.75
B	0.380	0.405	9.66	10.28
C	0.160	0.190	4.07	4.82
D	0.025	0.035	0.64	0.88
F	0.142	0.147	3.61	3.73
G	0.095	0.105	2.42	2.66
H	0.110	0.155	2.80	3.93
J	0.014	0.022	0.36	0.55
K	0.500	0.562	12.70	14.27
L	0.045	0.055	1.15	1.39
N	0.190	0.210	4.83	5.33
Q	0.100	0.120	2.54	3.04
R	0.080	0.110	2.04	2.79
S	0.045	0.055	1.15	1.39
T	0.235	0.255	5.97	6.47
U	0.000	0.050	0.00	1.27
V	0.045	—	1.15	—
Z	—	0.080	—	2.04

**CASE 221A-04  
(TO-220AB)**

Motorola reserves the right to make changes without further notice to any products herein. Motorola makes no warranty, representation or guarantee regarding the suitability of its products for any particular purpose, nor does Motorola assume any liability arising out of the application or use of any product or circuit, and specifically disclaims any and all liability, including without limitation consequential or incidental damages. "Typical" parameters can and do vary in different applications. All operating parameters, including "Typicals" must be validated for each customer application by customer's technical experts. Motorola does not convey any license under its patent rights nor the rights of others. Motorola products are not designed, intended, or authorized for use as components in systems intended for surgical implant into the body, or other applications intended to support or sustain life, or for any other application in which the failure of the Motorola product could create a situation where personal injury or death may occur. Should Buyer purchase or use Motorola products for any such unintended or unauthorized application, Buyer shall indemnify and hold Motorola and its officers, employees, subsidiaries, affiliates, and distributors harmless against all claims, costs, damages, and expenses, and reasonable attorney fees arising out of, directly or indirectly, any claim of personal injury or death associated with such unintended or unauthorized use, even if such claim alleges that Motorola was negligent regarding the design or manufacture of the part. Motorola and  are registered trademarks of Motorola, Inc. Motorola, Inc. is an Equal Opportunity/Affirmative Action Employer.

**Literature Distribution Centers:**

USA: Motorola Literature Distribution; P.O. Box 20912; Phoenix, Arizona 85036.

EUROPE: Motorola Ltd.; European Literature Centre; 88 Tanners Drive, Blakelands, Milton Keynes, MK14 5BP, England.

JAPAN: Nippon Motorola Ltd.; 4-32-1, Nishi-Gotanda, Shinagawa-ku, Tokyo 141, Japan.

ASIA PACIFIC: Motorola Semiconductors H.K. Ltd.; Silicon Harbour Center, No. 2 Dai King Street, Tai Po Industrial Estate, Tai Po, N.T., Hong Kong.

