

MAC15 Series

Preferred Device

Triacs

Silicon Bidirectional Thyristors

Designed primarily for full-wave ac control applications, such as solid-state relays, motor controls, heating controls and power supplies; or wherever full-wave silicon gate controlled solid-state devices are needed. Triac type thyristors switch from a blocking to a conducting state for either polarity of applied main terminal voltage with positive or negative gate triggering.

Features

- Blocking Voltage to 800 V
- All Diffused and Glass Passivated Junctions for Greater Parameter Uniformity and Stability
- Small, Rugged, Thermowatt Construction for Low Thermal Resistance, High Heat Dissipation and Durability
- Gate Triggering Guaranteed in Three Modes (MAC15 Series) or Four Modes (MAC15A Series)
- Pb-Free Packages are Available*

MAXIMUM RATINGS (T_J = 25°C unless otherwise noted)

Rating	Symbol	Value	Unit
Peak Repetitive Off-State Voltage Note 1 (T _J = -40 to +125°C, Sine Wave 50 to 60 Hz, Gate Open) MAC15A6 MAC15-8, MAC15A8 MAC15-10, MAC15A10	V _{DRM} , V _{RRM}	400 600 800	V
Peak Gate Voltage (Pulse Width ≤ 1.0 μsec; T _C = 90°C)	V _{GM}	10	V
On-State Current RMS; Full Cycle Sine Wave 50 to 60 Hz (T _C = +90°C)	I _{T(RMS)}	15	A
Circuit Fusing Consideration (t = 8.3 ms)	I ² t	93	A ² s
Peak Non-Repetitive Surge Current (One Full Cycle Sine Wave, 60 Hz, T _C = +80°C) Preceded and Followed by Rated Current	I _{TSM}	150	A
Peak Gate Power (T _C = +80°C, Pulse Width = 1.0 μs)	P _{GM}	20	W
Average Gate Power (T _C = +80°C, t = 8.3 ms)	P _{G(AV)}	0.5	W
Peak Gate Current (Pulse Width ≤ 1.0 μsec; T _C = 90°C)	I _{GM}	2.0	A
Operating Junction Temperature Range	T _J	-40 to +125	°C
Storage Temperature Range	T _{stg}	-40 to +150	°C

Stresses exceeding Maximum Ratings may damage the device. Maximum Ratings are stress ratings only. Functional operation above the Recommended Operating Conditions is not implied. Extended exposure to stresses above the Recommended Operating Conditions may affect device reliability.

1. V_{DRM} and V_{RRM} for all types can be applied on a continuous basis. Blocking voltages shall not be tested with a constant current source such that the voltage ratings of the devices are exceeded.

*For additional information on our Pb-Free strategy and soldering details, please download the ON Semiconductor Soldering and Mounting Techniques Reference Manual, SOLDERRM/D.



ON Semiconductor®

<http://onsemi.com>

TRIACS
15 AMPERES RMS
400 thru 800 VOLTS

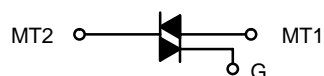

MARKING DIAGRAM

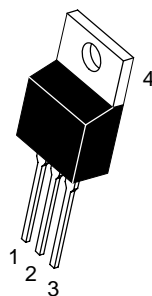

TO-220AB
CASE 221A
STYLE 4

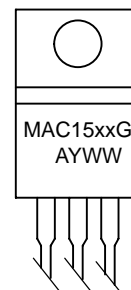

MAC15xx = Specific Device Code
xx = See Table on Page 2
A = Assembly Location
Y = Year
WW = Work Week
G = Pb-Free Package

PIN ASSIGNMENT

Pin	Assignment
1	Main Terminal 1
2	Main Terminal 2
3	Gate
4	Main Terminal 2

ORDERING INFORMATION

See detailed ordering, marking, and shipping information in the package dimensions section on page 2 of this data sheet.

Preferred devices are recommended choices for future use and best overall value.

MAC15 Series

THERMAL CHARACTERISTICS

Characteristic	Symbol	Value	Unit
Thermal Resistance, Junction-to-Case	$R_{\theta JC}$	2.0	$^{\circ}C/W$
Thermal Resistance, Junction-to-Ambient	$R_{\theta JA}$	62.5	$^{\circ}C/W$
Maximum Lead Temperature for Soldering Purposes 1/8" from Case for 10 Seconds	T_L	260	$^{\circ}C$

ELECTRICAL CHARACTERISTICS ($T_C = 25^{\circ}C$ unless otherwise noted; Electricals apply in both directions)

Characteristic	Symbol	Min	Typ	Max	Unit
----------------	--------	-----	-----	-----	------

OFF CHARACTERISTICS

Peak Blocking Current ($V_D = \text{Rated } V_{DRM}, V_{RRM}; \text{ Gate Open}$)	$T_J = 25^{\circ}C$ $T_J = 125^{\circ}C$	I_{DRM}	-	-	10	μA
		I_{RRM}	-	-	2.0	mA

ON CHARACTERISTICS

Peak On-State Voltage Note 2 ($I_{TM} = \pm 21 \text{ A Peak}$)	V_{TM}	-	1.3	1.6	V
Gate Trigger Current (Continuous dc) ($V_D = 12 \text{ Vdc}, R_L = 100 \Omega$) MT2(+), G(+) MT2(+), G(-) MT2(-), G(-) MT2(-), G(+) "A" SUFFIX ONLY	I_{GT}	-	-	50	mA
		-	-	50	
		-	-	50	
		-	-	75	
Gate Trigger Voltage (Continuous dc) ($V_D = 12 \text{ Vdc}, R_L = 100 \Omega$) MT2(+), G(+) MT2(+), G(-) MT2(-), G(-) MT2(-), G(+) "A" SUFFIX ONLY	V_{GT}	-	0.9	2	V
		-	0.9	2	
		-	1.1	2	
		-	1.4	2.5	
Gate Non-Trigger Voltage ($V_D = 12 \text{ V}, R_L = 100 \Omega, T_J = 110^{\circ}C$) MT2(+), G(+); MT2(-), G(-); MT2(+), G(-) MT2(-), G(+) "A" SUFFIX ONLY	V_{GD}	0.2	-	-	V
		0.2	-	-	
Holding Current ($V_D = 12 \text{ Vdc}, \text{ Gate Open}, \text{ Initiating Current} = \pm 200 \text{ mA}$)	I_H	-	6.0	40	mA
Turn-On Time ($V_D = \text{Rated } V_{DRM}, I_{TM} = 17 \text{ A}$) ($I_{GT} = 120 \text{ mA}, \text{ Rise Time} = 0.1 \mu s, \text{ Pulse Width} = 2 \mu s$)	t_{gt}	-	1.5	-	μs

DYNAMIC CHARACTERISTICS

Critical Rate of Rise of Commutation Voltage ($V_D = \text{Rated } V_{DRM}, I_{TM} = 21 \text{ A}, \text{ Commutating } di/dt = 7.6 \text{ A/ms}, \text{ Gate Unenergized}, T_C = 80^{\circ}C$)	$dv/dt(c)$	-	5.0	-	V/ μs
---	------------	---	-----	---	------------

2. Pulse Test: Pulse Width $\leq 2.0 \text{ ms}$, Duty Cycle $\leq 2\%$.

ORDERING INFORMATION

Device	Device Marking	Package	Shipping
MAC15-008	MAC15-8	TO-220AB	500 Units Bulk
MAC15-8G		TO-220AB (Pb-Free)	
MAC15-10	MAC1510	TO-220AB	
MAC15-10G		TO-220AB (Pb-Free)	
MAC15A6	MAC15A6	TO-220AB	
MAC15A6G		TO-220AB (Pb-Free)	
MAC15A8	MAC15A8	TO-220AB	
MAC15A8G		TO-220AB (Pb-Free)	
MAC15A10	MAC15A10	TO-220AB	
MAC15A10G		TO-220AB (Pb-Free)	
MAC15A10T		TO-220AB	50 Units / Rail

MAC15 Series

Voltage Current Characteristic of Triacs (Bidirectional Device)

Symbol	Parameter
V_{DRM}	Peak Repetitive Forward Off State Voltage
I_{DRM}	Peak Forward Blocking Current
V_{RRM}	Peak Repetitive Reverse Off State Voltage
I_{RRM}	Peak Reverse Blocking Current
V_{TM}	Maximum On State Voltage
I_H	Holding Current

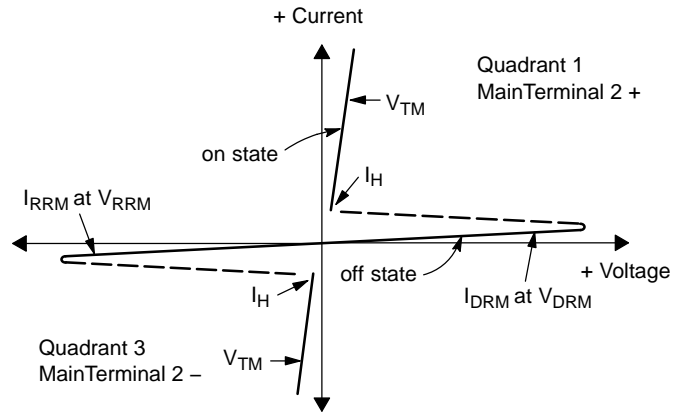

Quadrant Definitions for a Triac

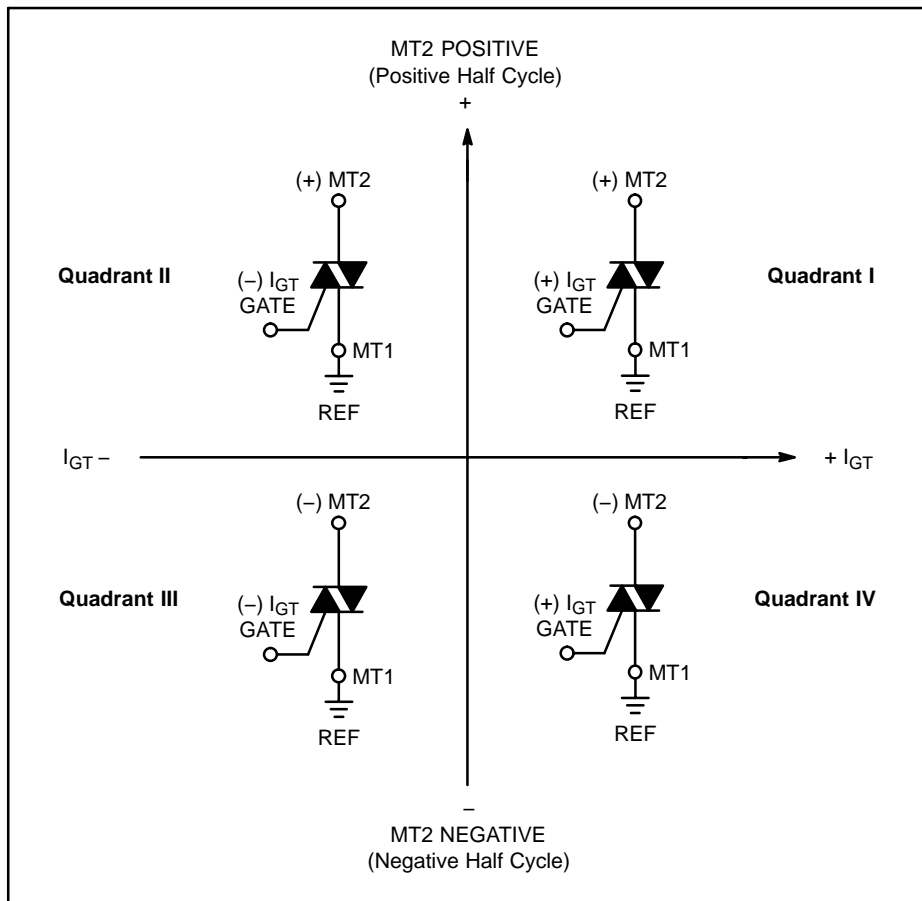

All polarities are referenced to MT1.
With in-phase signals (using standard AC lines) quadrants I and III are used.

MAC15 Series

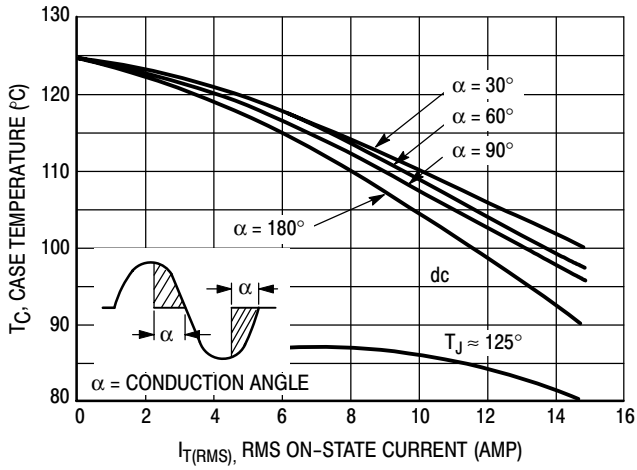

Figure 1. RMS Current Derating

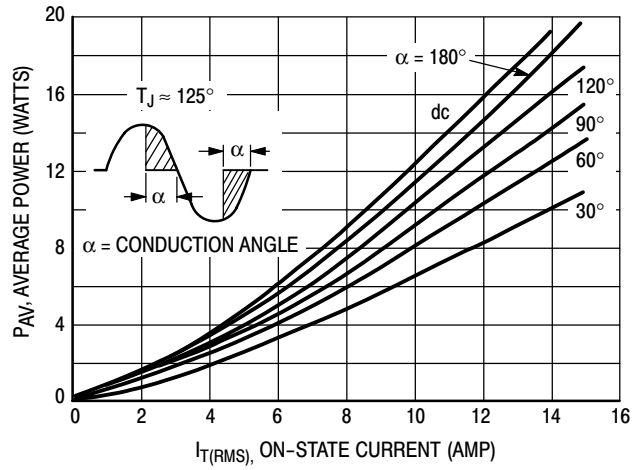

Figure 2. On-State Power Dissipation

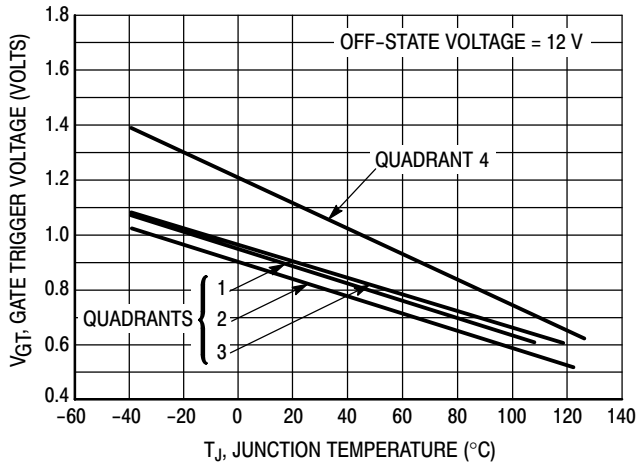

Figure 3. Typical Gate Trigger Voltage

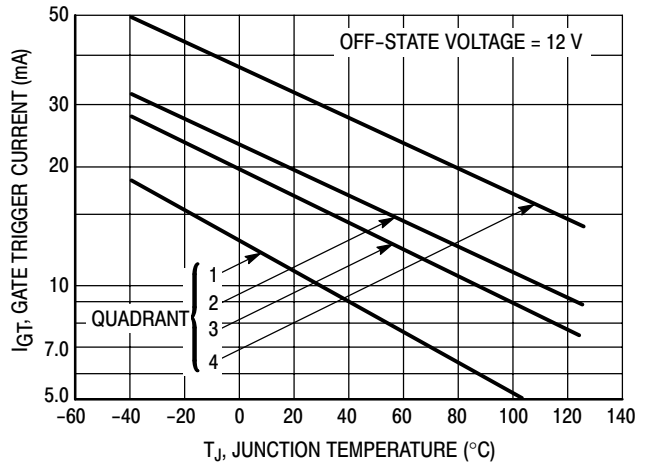

Figure 4. Typical Gate Trigger Current

MAC15 Series

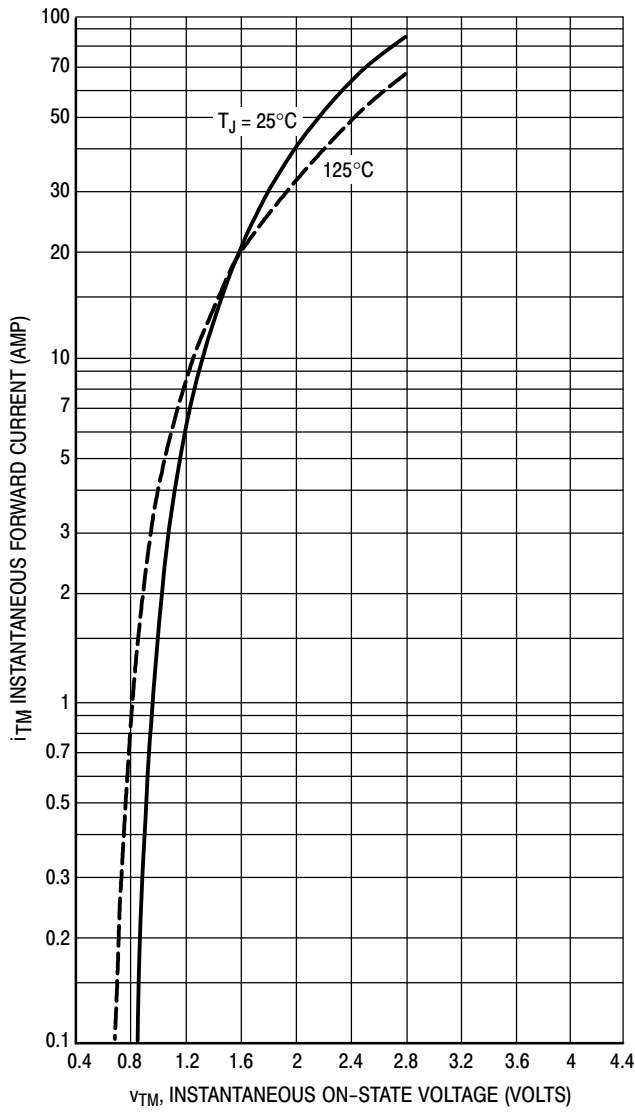

Figure 5. On-State Characteristics

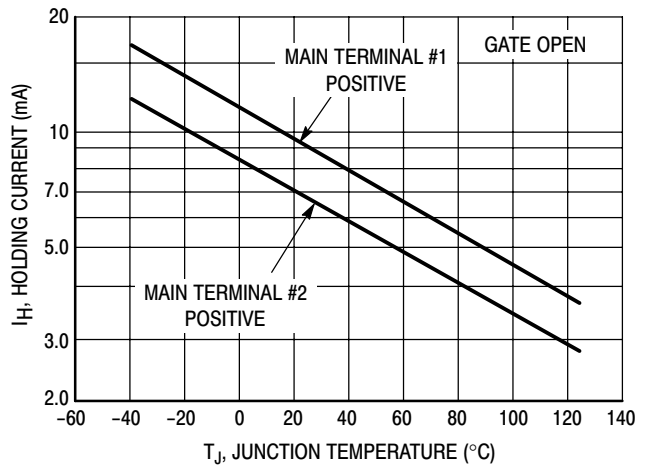

Figure 6. Typical Holding Current

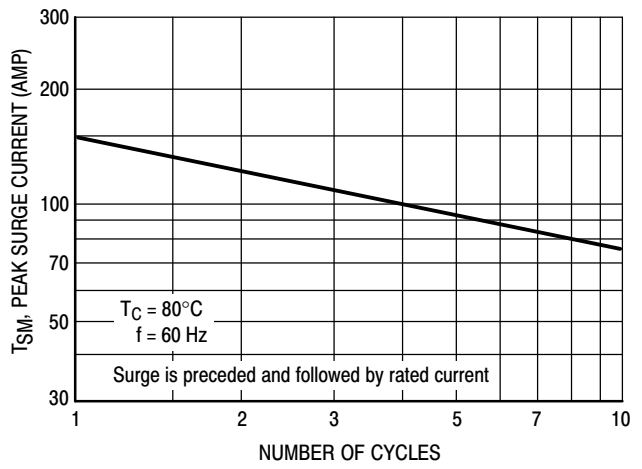

Figure 7. Maximum Non-Repetitive Surge Current

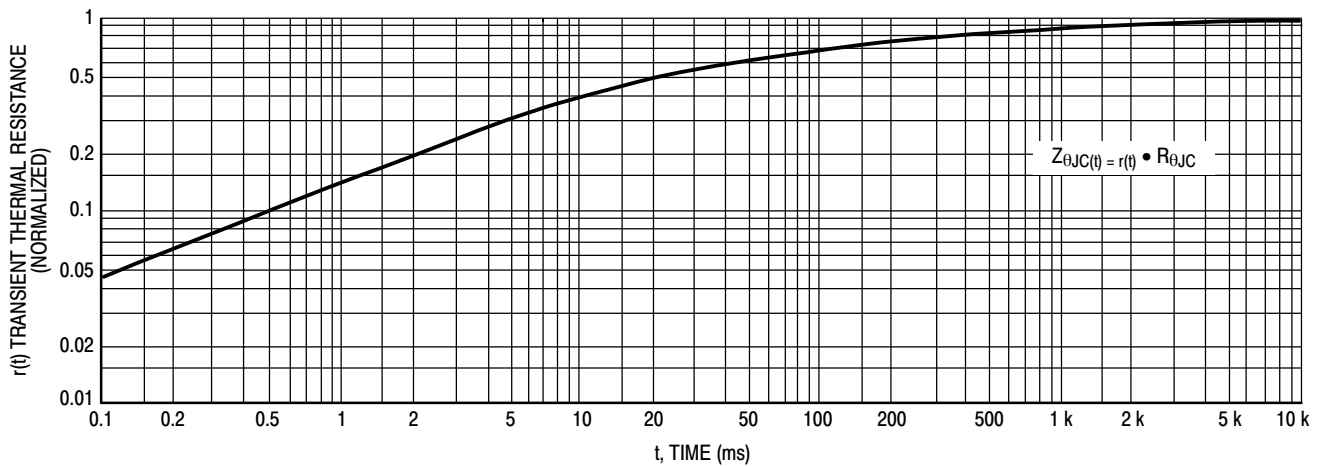
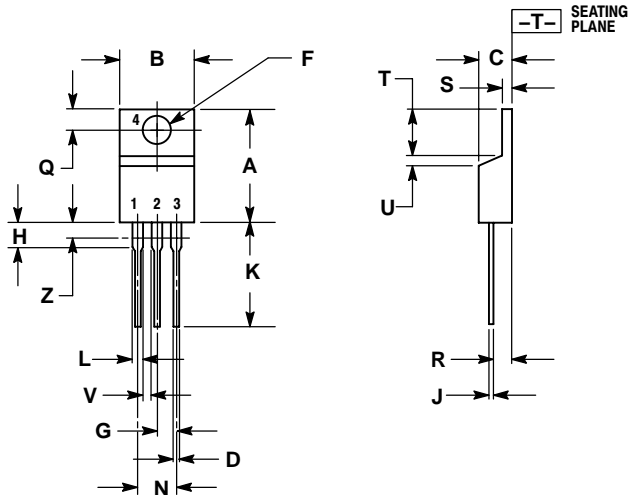

Figure 8. Thermal Response

MAC15 Series

PACKAGE DIMENSIONS

TO-220AB
CASE 221A-09
ISSUE AD



NOTES:

1. DIMENSIONING AND TOLERANCING PER ANSI Y14.5M, 1982.
2. CONTROLLING DIMENSION: INCH.
3. DIMENSION Z DEFINES A ZONE WHERE ALL BODY AND LEAD IRREGULARITIES ARE ALLOWED.

DIM	INCHES		MILLIMETERS	
	MIN	MAX	MIN	MAX
A	0.570	0.620	14.48	15.75
B	0.380	0.405	9.66	10.28
C	0.160	0.190	4.07	4.82
D	0.025	0.035	0.64	0.88
F	0.142	0.147	3.61	3.73
G	0.095	0.105	2.42	2.66
H	0.110	0.155	2.80	3.93
J	0.018	0.025	0.46	0.64
K	0.500	0.562	12.70	14.27
L	0.045	0.060	1.15	1.52
N	0.190	0.210	4.83	5.33
Q	0.100	0.120	2.54	3.04
R	0.080	0.110	2.04	2.79
S	0.045	0.055	1.15	1.39
T	0.235	0.255	5.97	6.47
U	0.000	0.050	0.00	1.27
V	0.045	---	1.15	---
Z	---	0.080	---	2.04

STYLE 4:

- PIN 1. MAIN TERMINAL 1
2. MAIN TERMINAL 2
3. GATE
4. MAIN TERMINAL 2

ON Semiconductor and are registered trademarks of Semiconductor Components Industries, LLC (SCILLC). SCILLC reserves the right to make changes without further notice to any products herein. SCILLC makes no warranty, representation or guarantee regarding the suitability of its products for any particular purpose, nor does SCILLC assume any liability arising out of the application or use of any product or circuit, and specifically disclaims any and all liability, including without limitation special, consequential or incidental damages. "Typical" parameters which may be provided in SCILLC data sheets and/or specifications can and do vary in different applications and actual performance may vary over time. All operating parameters, including "Typicals" must be validated for each customer application by customer's technical experts. SCILLC does not convey any license under its patent rights nor the rights of others. SCILLC products are not designed, intended, or authorized for use as components in systems intended for surgical implant into the body, or other applications intended to support or sustain life, or for any other application in which the failure of the SCILLC product could create a situation where personal injury or death may occur. Should Buyer purchase or use SCILLC products for any such unintended or unauthorized application, Buyer shall indemnify and hold SCILLC and its officers, employees, subsidiaries, affiliates, and distributors harmless against all claims, costs, damages, and expenses, and reasonable attorney fees arising out of, directly or indirectly, any claim of personal injury or death associated with such unintended or unauthorized use, even if such claim alleges that SCILLC was negligent regarding the design or manufacture of the part. SCILLC is an Equal Opportunity/Affirmative Action Employer. This literature is subject to all applicable copyright laws and is not for resale in any manner.

PUBLICATION ORDERING INFORMATION

LITERATURE FULFILLMENT:
Literature Distribution Center for ON Semiconductor
P.O. Box 5163, Denver, Colorado 80217 USA
Phone: 303-675-2175 or 800-344-3860 Toll Free USA/Canada
Fax: 303-675-2176 or 800-344-3867 Toll Free USA/Canada
Email: orderlit@onsemi.com

N. American Technical Support: 800-282-9855 Toll Free
USA/Canada
Europe, Middle East and Africa Technical Support:
Phone: 421 33 790 2910
Japan Customer Focus Center
Phone: 81-3-5773-3850

ON Semiconductor Website: www.onsemi.com
Order Literature: <http://www.onsemi.com/orderlit>

For additional information, please contact your local Sales Representative