

VOLTAGE REGULATOR

MB3756

May 1988
Edition 2.0

VOLTAGE REGULATOR

The Fujitsu MB3756 monolithic voltage regulator with three outputs is fabricated with a bipolar linear IC technology. Two alternately exchangeable outputs are provided for two stabilized output levels and controlled by an external control signal. Switching noise is prevented by internal circuitry that is suitable for switching between modes such as transmitting and receiving or AM and FM. The MB3756 is packaged in an 8-pin single-in-line package with a heat radiation fin to allow large power consumption.

- No need for external components
- Good balance between three outputs
- On-chip noise protection circuitry
- On-chip overload current protection and thermal protection circuitry
- Good mountability
- High output current : 200 mA typical for V₀₂ output
: 100 mA typical for V₀₀, V₀₁ outputs

ABSOLUTE MAXIMUM RATINGS (see NOTE) TA = 25°C

Rating	Symbol	Value	Unit
Input Voltage	V _{IN}	18	V
Power Dissipation	P _D	1 *1	W
		4 *2	W
Operating Temperature	T _C	-20 to +75	°C
Storage Temperature	T _{STG}	-55 to +125	°C

Notes: *1 No Heat Sink (TA ≤ 70°C)
*2 Infinite Heat Sink (TA ≤ 70°C)

Permanent device damage may occur if the above Absolute Maximum Ratings are exceeded. Functional operation should be restricted to the conditions as detailed in the operational sections of this data sheet. Exposure to absolute maximum rating conditions for extended periods may affect device reliability.

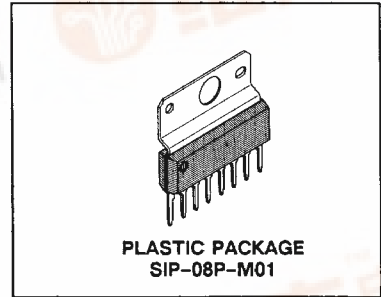

4

PIN ASSIGNMENT

(FRONT VIEW)

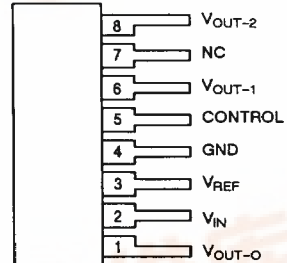

This device contains circuitry to protect the inputs against damage due to high static voltages or electric fields. However, it is advised that normal precautions be taken to avoid application of any voltage higher than maximum rated voltages to this high impedance circuit.





MB3756

Fig. 1 — MB3756 EQUIVALENT CIRCUIT

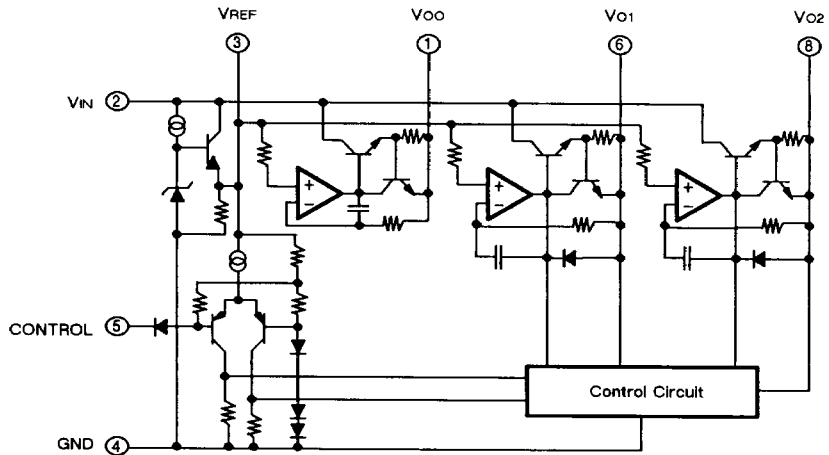

4

RECOMMENDED OPERATING CONDITIONS

Parameter	Symbol	Value			Unit
		Min	Typ	Max	
Input Voltage	V_{IN}	11	-	16	V
Load Current	I_{L1} *1	0	-	100	mA
	I_{L2} *2	0	-	200	mA
Operating Temperature	T_c	-20	-	+75	°C

Note : *1 V_{00} , V_{01}
 *2 V_{02}

ELECTRICAL CHARACTERISTICS

($T_C = 25^\circ\text{C}$, $V_{IN} = 14\text{ V}$, $R_{L0} = R_{L1} = 200\ \Omega$, $R_{L2} = 100\ \Omega$)

Parameter	Symbol	Condition	Values			Unit
			Min	Typ	Max	
Input Voltage	V_{IN}	—	10.6	—	18	V
Output Voltage	V_O	—	7.8	8.2	8.6	V
Input Regulation	—	$11\text{ V} \leq V_{IN} \leq 18\text{ V}$	—	20	100	mV
Load Regulation	—	$(V_{O0}, V_{O1})\ 1\text{ mA} \leq I_L \leq 100\text{ mA}$	—	15	80	mV
	—	$(V_{O2})\ 1\text{ mA} \leq I_L \leq 200\text{ mA}$	—	20	100	mV
	—	$(V_{O0}, V_{O1})\ 1\text{ mA} \leq I_L \leq 100\text{ mA}$ $V_{IN} = 11.5\text{ V}$	—	20	100	mV
	—	$(V_{O2})\ 1\text{ mA} \leq I_L \leq 200\text{ mA}$ $V_{IN} = 11.5\text{ V}$	—	30	150	mV
Bias Current	I_B	$V_{IN} = 18\text{ V}$	—	6	10	mA
Ripple Rejection Ratio	—	$f = 100\text{ Hz}$	—	60	—	dB
Output Noise Voltage	—	$10\text{ Hz} \leq f \leq 100\text{ kHz}$, $C_R = 10\ \mu\text{F}$	—	40	—	μV
Input to Output Voltage Differential	$V_{IN} - V_O$	—	—	1.7	—	V
Temperature Coefficient of Output Voltage	TCV_O	—	—	-0.4	—	mV/C°
Output Voltage Deviation	ΔV_O	—	—	10	50	mV
Short Circuit Output Current	I_{SC}	(V_{O0}, V_{O1})	—	200	—	mA
		(V_{O2})	—	350	—	mA
Output Voltage	V_{O1L}	$V_{IC} = 0.8\text{ V}$	0	—	0.2	V
	V_{O2L}	$V_{IC} = 0.8\text{ V}$	7.8	8.2	8.6	V
	V_{O1H}	$V_{IC} = 2.0\text{ V}$	7.8	8.2	8.6	V
	V_{O2H}	$V_{IC} = 2.0\text{ V}$	0	—	0.2	V
Control Input Current	I_{IL}	$V_{ICL} = 0\text{ V}$	—	-0.2	-1.0	mA
	I_{IH}	$V_{ICH} = 18\text{ V}$, $V_{IN} = 18\text{ V}$	—	—	10	μA

TYPICAL PERFORMANCE CHARACTERISTICS

4

Fig. 2 — BIAS CURRENT vs INPUT VOLTAGE

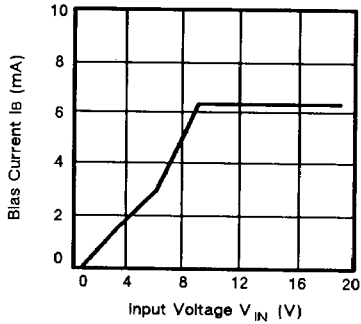

Fig.3 — INPUT TO OUTPUT VOLTAGE DIFFERENTIAL vs JUNCTION TEMPERATURE

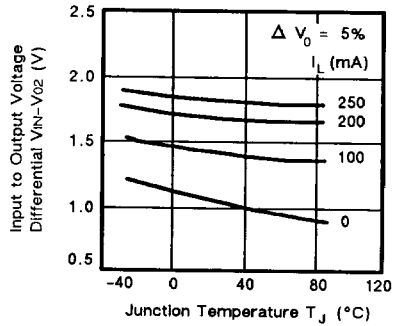

Fig. 4 — OUTPUT NOISE VOLTAGE vs EXTERNAL CAPACITANCE

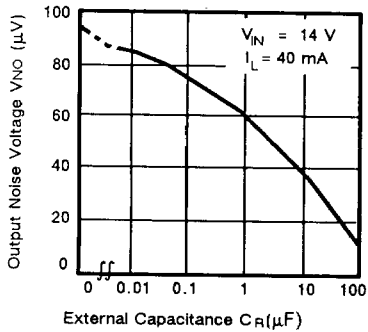
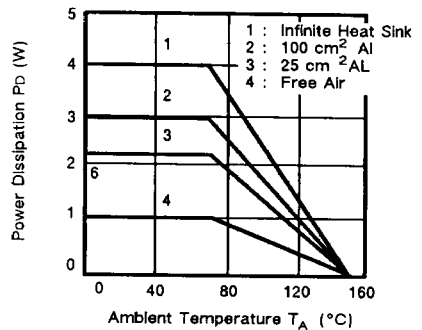
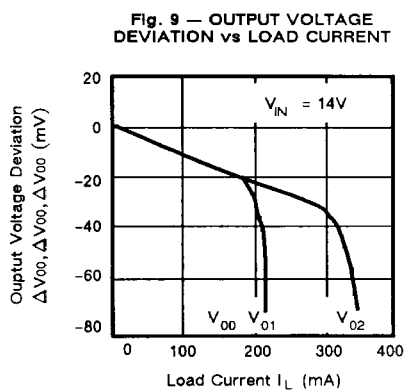
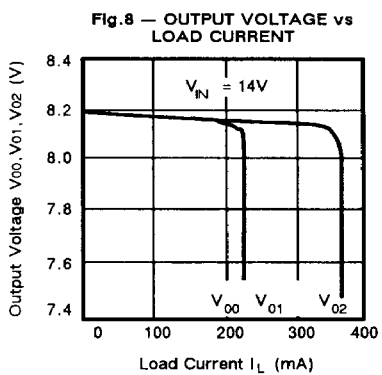
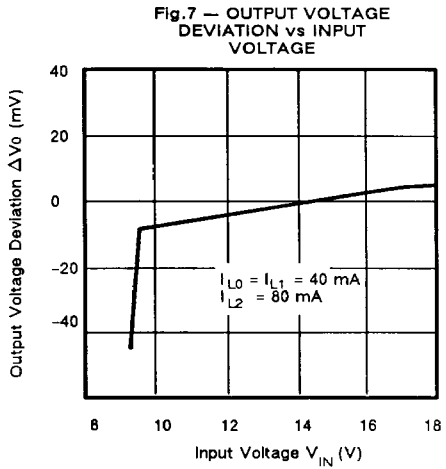
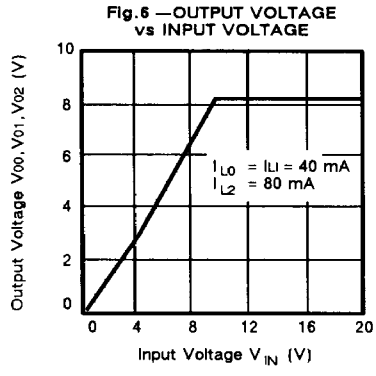

Fig. 5 — POWER DISSIPATION CURVES



TYPICAL PERFORMANCE CHARACTERISTICS (Continued)



TYPICAL PERFORMANCE CHARACTERISTICS (Continued)

4

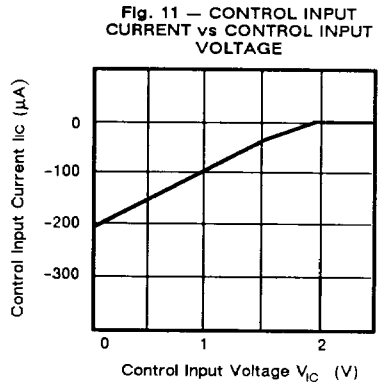
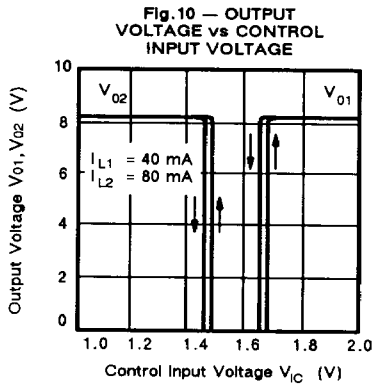
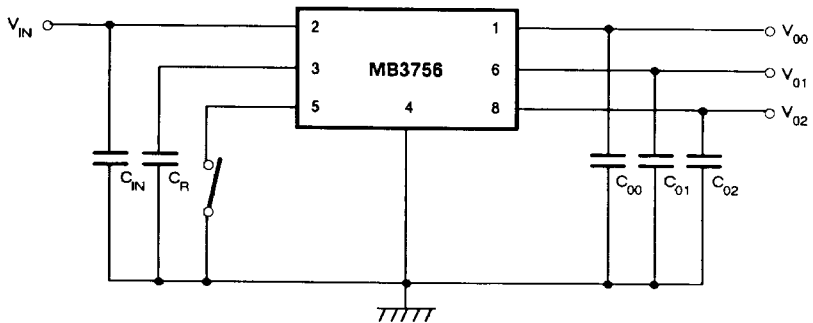

Fig. 12 — APPLICATION CIRCUIT



Note: C_{IN} is required if the regulator is located at a distance from the power supply filter.
 C_L improves output noise and ripple rejection.
 C_{00}, C_{01}, C_{02} improve transient response.

PACKAGE DIMENSIONS

