

ASSP For Power Management Applications (Secondary battery)

Lithium Ion Battery Charger DC/DC Converter IC (High Precision with Constant-current Function)

MB3813A/MB3833A/MB3843

DESCRIPTION

The FUJITSU MB3813A/33A/43 are pulse width modulation (PWM) DC/DC converter ICs with independent output voltage and current setting capability.

The use of on-chip output setting resistance enables high precision output voltage control. Also, an output voltage switching feature for use with either graphite-electrode or coke-electrode lithium-ion batteries makes this IC ideal for internal battery chargers in notebook personal computers and similar applications.

Cell count	Output voltage	Part number
3-cell	12.6 V/12.3 V	MB3813A
2-cell	8.4 V/8.2 V	MB3833A
1-cell	4.2 V/4.1 V	MB3843

FEATURES

- Output setting resistance is on-chip for high precision output voltage: $\pm 1.0\%$
- SEL pin enables output voltage selection
- High precision reference voltage source: $2.5\text{ V} \pm 1.0\%$
- High frequency operating capability: max. 500 kHz
- On-chip current detector amplifier with wide in-phase input voltage range: 0 V to V_{cc}

(Continued)

PACKAGE

16-pin plastic SSOP

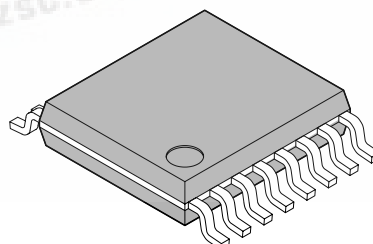

(FPT-16P-M05)

MB3813A/MB3833A/MB3843

(Continued)

- On-chip standby function
- On-chip input voltage detector circuit
- On-chip soft start control circuit
- On-chip output overshoot protection circuit for rapid load changes
- On-chip totem-pole output circuits for P-ch. MOS FET devices

MB3813A/MB3833A/MB3843

■ PIN ASSIGNMENT

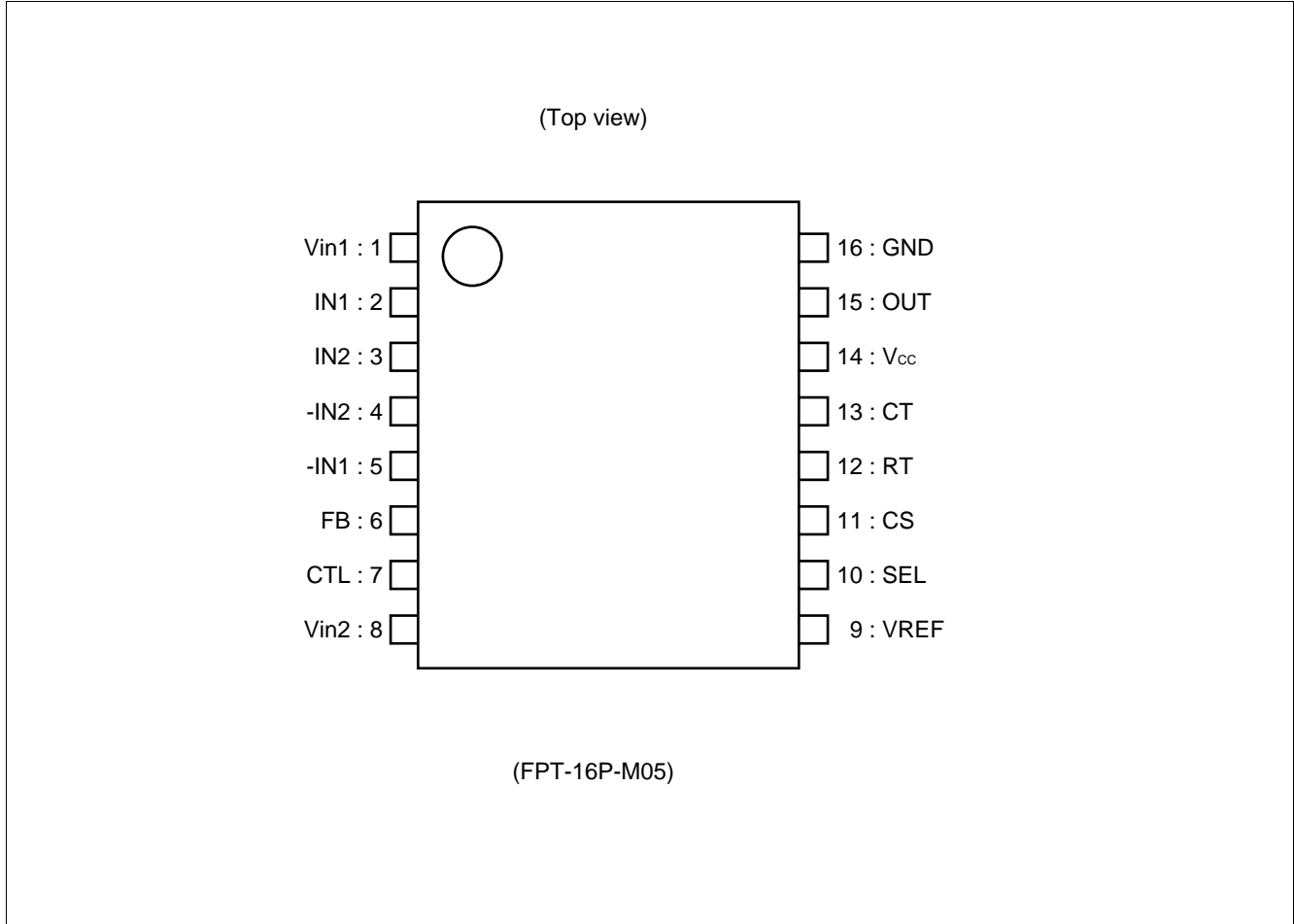

MB3813A/MB3833A/MB3843

■ PIN DESCRIPTION

Pin no.	Symbol	I/O	Descriptions
1	Vin1	I	Input voltage detector block (VLDET) input pin
2	IN1	I	Current detector amplifier (Current Amp.) input pin
3	IN2	I	Output voltage feedback input pin
4	-IN2	I	Error amplifier (Error Amp.2) inverted input pin
5	-IN1	I	Error amplifier (Error Amp.1) inverted input pin
6	FB	O	Error amplifier (Error Amp.1, 2 common) output pin
7	CTL	I	Power supply control pin An "L" level signal input to the CTL pin sets the IC in standby mode.
8	Vin2	I	DC/DC converter charging current setting input pin
9	VREF	O	Reference voltage output pin
10	SEL	I	Output voltage switching pin "L" level output voltage: MB3813A 12.6 V MB3833A 8.4 V MB3843 4.2 V "H" level output voltage: MB3813A 12.3 V MB3833A 8.2 V MB3843 4.1 V
11	CS	—	Soft start capacitor connection pin
12	RT	—	Triangular wave frequency setting resistor connection pin
13	CT	—	Triangular wave frequency setting capacitor connection pin
14	V _{CC}	—	Power supply pin
15	OUT	O	Totem-pole output pin
16	GND	—	Ground pin

MB3813A/MB3833A/MB3843

■ BLOCK DIAGRAM

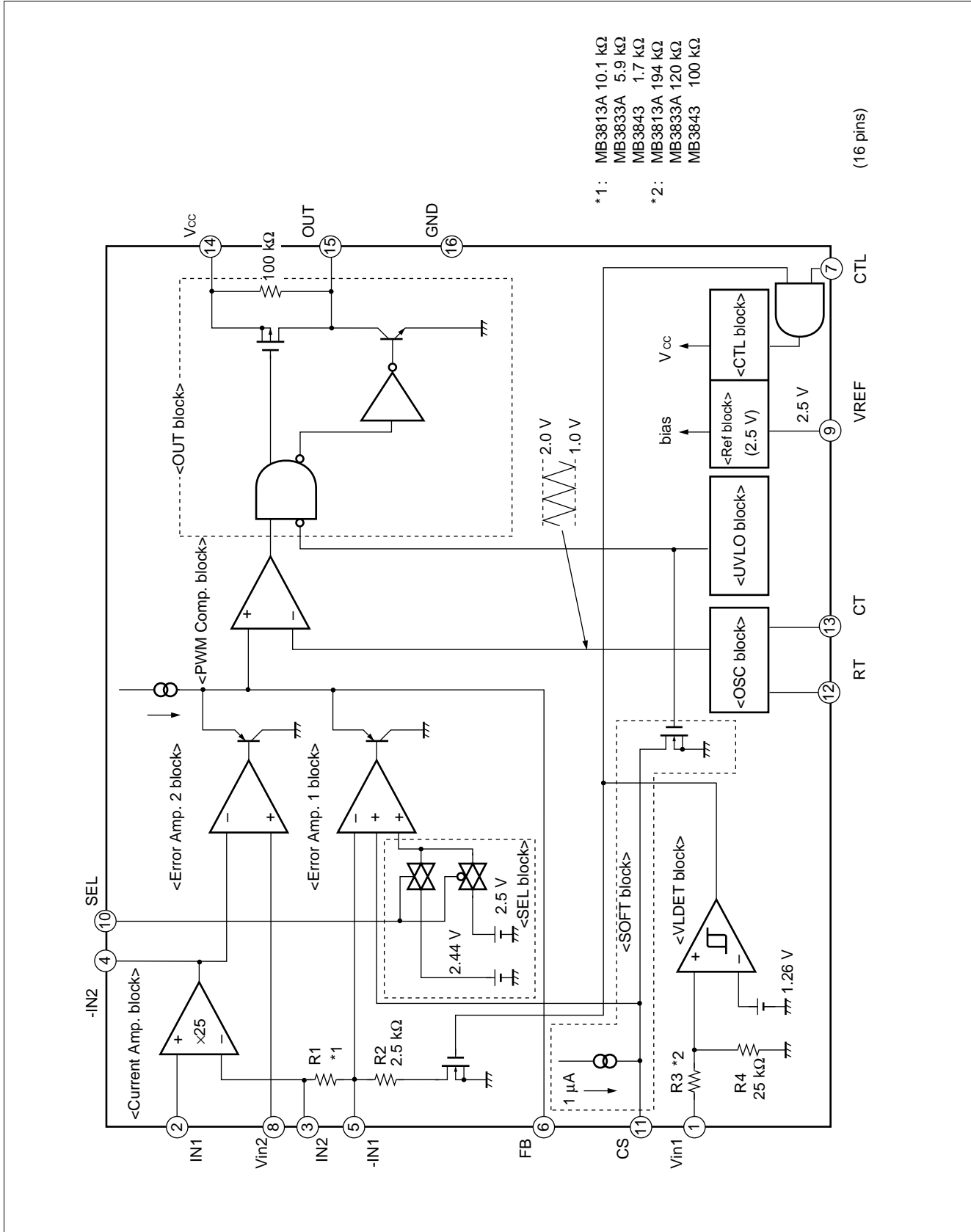

MB3813A/MB3833A/MB3843

■ ABSOLUTE MAXIMUM RATINGS

Parameter	Symbol	Condition	Value		Unit
			Min.	Max.	
Power supply voltage	V _{CC}	—	—	20	V
Input voltage	V _{IN}	Vin1, IN1, IN2	—	20	V
Control input voltage	V _{CTL}	—	—	20	V
Select input voltage	V _{SEL}	—	—	20	V
Output current	I _O	—	—	50	mA
Peak output current	I _O	Duty ≤ 5% (t = f _{osc} × Duty)	—	500	mA
Allowable dissipation	P _D	T _a ≤ +25°C	—	440*	mW
Storage temperature	T _{stg}	—	-55	+125	°C

* : When mounted on a 10 by 10 centimeters square dual-sided epoxy base board

WARNING: Semiconductor devices can be permanently damaged by application of stress (voltage, current, temperature, etc.) in excess of absolute maximum ratings. Do not exceed these ratings.

■ RECOMMENDED OPERATING CONDITIONS

Parameter	Symbol	Condition	Value			Unit
			Min.	Typ.	Max.	
Power supply voltage	V _{CC}	MB3813A	12	16	18	V
		MB3833A	8	16	18	V
		MB3843	7	16	18	V
Reference voltage output current	I _{OR}	—	-1	—	0	mA
Input voltage	V _{IN}	Vin1, IN1, IN2	0	—	18	V
	V _{IN}	Vin2	0	—	2.5	V
Control input voltage	V _{CTL}	—	0	—	18	V
Select input voltage	V _{SEL}	—	0	—	18	V
Peak output current	I _O	Duty ≤ 5% (t = f _{osc} × Duty)	-300	—	300	mA
Oscillator frequency	f _{OSC}	—	10	200	500	kHz
Soft start capacitance	C _S	—	—	0.1	1.0	μF
Timing resistance	R _T	—	10	15	100	kΩ
Timing capacitance	C _T	—	100	330	10000	pF
Operating temperature	T _a	—	-30	25	85	°C

WARNING: The recommended operating conditions are required in order to ensure the normal operation of the semiconductor device. All of the device's electrical characteristics are warranted when the device is operated within these ranges.

Always use semiconductor devices within their recommended operating condition ranges. Operation outside these ranges may adversely affect reliability and could result in device failure.

No warranty is made with respect to uses, operating conditions, or combinations not represented on the data sheet. Users considering application outside the listed conditions are advised to contact their FUJITSU representatives beforehand.

MB3813A/MB3833A/MB3843

■ ELECTRICAL CHARACTERISTICS

($V_{CC} = V_{in1} = +16\text{ V}$, $V_{SEL} = 0\text{ V}$, $T_a = +25^\circ\text{C}$)

Parameter	Symbol	Pinno.	Condition	Value			Unit	Remarks	
				Min.	Typ.	Max.			
Reference voltage block (Ref)	Output voltage	V_{REF}	9	—	2.475	2.500	2.525	V	
	Input stability	Line	9	$V_{CC} = 12\text{ V to }18\text{ V}$	—	1.0	10.0	mV	MB3813A
		Line	9	$V_{CC} = 8\text{ V to }18\text{ V}$	—	1.0	10.0	mV	MB3833A
		Line	9	$V_{CC} = 7\text{ V to }18\text{ V}$	—	1.0	10.0	mV	MB3843
	Load stability	Load	9	$V_{REF} = -0\text{ }\mu\text{A to }-500\text{ }\mu\text{A}$	—	3.0	10.0	mV	
Under voltage lockout circuit block (UVLO)	Threshold voltage	V_{TH}	9	$V_{REF} = \text{“L”} \rightarrow \text{“H”}$	1.8	2.0	2.2	V	
	Hysteresis voltage	V_H	9	—	—	0.2	0.35	V	
Input voltage detector block (VLDET)	Threshold voltage	V_{TH}	1	$V_{in1} = \text{“L”} \rightarrow \text{“H”}$	10.2	11.0	11.8	V	MB3813A
		V_{TH}	1		6.7	7.3	7.9	V	MB3833A
		V_{TH}	1		5.8	6.3	6.8	V	MB3843
	Hysteresis voltage	V_H	1	—	—	1.0	2.0	V	MB3813A
		V_H	1		—	0.7	1.4	V	MB3833A
		V_H	1		—	0.57	1.2	V	MB3843
	Input current	I_{IH}	1	$V_{in1} = 16\text{ V}$	—	150	300	μA	MB3813A
			1		—	270	540	μA	MB3833A
			1		—	310	620	μA	MB3843
		I_{IL}	1	$V_{in1} = 0\text{ V}$	-1.0	—	1.0	μA	
Soft start block (UVLO)	Charge current	I_{CS}	11	—	-1.4	-1.0	-0.6	μA	
Triangular wave oscillator block (OSC)	Oscillator frequency	f_{OSC}	15	$CT = 330\text{ pF}$, $RT = 15\text{ k}\Omega$	180	200	220	kHz	
Error amplifier (Error Amp.1)	Threshold voltage	V_{T1}	3	$FB = 1.5\text{ V}$, $SEL = 0\text{ V}$	12.474	12.60	12.726	V	MB3813A
		V_{T1}	3		8.316	8.40	8.484	V	MB3833A
		V_{T1}	3		4.158	4.20	4.242	V	MB3843
		V_{T1}	3	$FB = 1.5\text{ V}$, $T_a = -30^\circ\text{C to }+85^\circ\text{C}$	12.41	12.60	12.79	V	MB3813A
		V_{T1}	3		8.27	8.40	8.53	V	MB3833A
		V_{T1}	3		4.13	4.20	4.26	V	MB3843

(Continued)

MB3813A/MB3833A/MB3843

($V_{CC} = V_{in1} = +16\text{ V}$, $V_{SEL} = 0\text{ V}$, $T_a = +25^\circ\text{C}$)

Parameter	Symbol	Pinno.	Condition	Value			Unit	Remarks	
				Min.	Typ.	Max.			
Error amplifier (Error Amp.1)	Threshold voltage	VT2	3	FB = 1.5 V, SEL = 5 V	12.177	12.30	12.423	V	MB3813A
		VT2	3		8.118	8.20	8.282	V	MB3833A
		VT2	3		4.059	4.10	4.141	V	MB3843
		VT2	3	FB = 1.5 V, Ta = -30°C to +85°C	12.11	12.30	12.49	V	MB3813A
		VT2	3		8.07	8.20	8.33	V	MB3833A
		VT2	3		4.04	4.10	4.16	V	MB3843
	Input stability	Line	3	$V_{CC} = 13\text{ V to }18\text{ V}$, output 12.6 V	—	2.5	10.0	mV	MB3813A
		Line	3	$V_{CC} = 9\text{ V to }18\text{ V}$, output 8.4 V	—	2.5	10.0	mV	MB3833A
		Line	3	$V_{CC} = 7\text{ V to }18\text{ V}$, output 4.2 V	—	2.5	10.0	mV	MB3843
	Input current	IIN2	3	IN1 = 12.7 V, IN2 = 12.6 V	—	1.0	2.0	mA	MB3813A
		IIN2	3	IN1 = 8.5 V, IN2 = 8.4 V	—	1.0	2.0	mA	MB3833A
		IIN2	3	IN1 = 4.3 V, IN2 = 4.2 V	—	1.0	2.0	mA	MB3843
		IIN2	3	Vin1 = 0 V, IN2 = 12.6 V	-1.0	—	1.0	μA	MB3813A
		IIN2	3	Vin1 = 0 V, IN2 = 8.4 V	-1.0	—	1.0	μA	MB3833A
		IIN2	3	Vin1 = 0 V, IN2 = 4.2 V	-1.0	—	1.0	μA	MB3843
	Input resistance	R1	3	—	7.0	10.1	13.2	kΩ	MB3813A
		R1	3		4.1	5.9	7.7	kΩ	MB3833A
		R1	3		1.2	1.7	2.3	kΩ	MB3843
		R2	5		1.7	2.5	3.3	kΩ	
	Error amplifier (Error Amp.2)	Input bias current	IB	8	Vin2	-400	-30	—	nA
Input offset voltage		V _{IO}	5	FB = 1.5 V	—	—	5	mV	
Error amplifiers (Error Amp.1,2 common)	Voltage gain	AV	—	DC	—	100*	—	dB	
	Frequency bandwidth	BW	—	AV = 0 dB	—	800*	—	kHz	
	Output voltage	V _{OH}	6	—	2.3	2.5	—	V	
		V _{OL}	6	—	—	0.8	0.9	V	
	Output source current	I _{SOURCE}	6	FB = 1.5 V	—	-120	-60	μA	
Output sink current	I _{SINK}	6	FB = 1.5 V	0.6	2.0	—	mA		

* : Standard design value

(Continued)

MB3813A/MB3833A/MB3843

($V_{CC} = V_{in1} = +16\text{ V}$, $V_{SEL} = 0\text{ V}$, $T_a = +25^\circ\text{C}$)

Parameter	Symbol	PinNo.	Condition	Value			Unit	Remarks		
				Min.	Typ.	Max.				
Current detector amplifier block (Current Amp.)	Threshold voltage	VT1	2	IN2 = 3 V to V_{CC} VT1 = $V_{TH} - IN2$	IN2 = 2.5 V	90	100	110	mV	MB3813A
		VT1	2		IN2 = 0.75 V	20	30	40	mV	MB3813A
		VT1	2	IN2 = 3 V to V_{CC} VT1 = $V_{TH} - IN2$	IN2 = 2.5 V	90	100	110	mV	MB3833A
		VT1	2		IN2 = 0.75 V	20	30	40	mV	MB3833A
		VT1	2	IN2 = 3 V to V_{CC} VT1 = $V_{TH} - IN2$	IN2 = 2.5 V	90	100	110	mV	MB3843
		VT1	2		IN2 = 0.75 V	20	30	40	mV	MB3843
		VT2	2	IN2 = 0 V VT2 = $V_{TH} - IN2$	IN2 = 2.5 V	50	100	150	mV	
		VT2	2		IN2 = 0.75 V	5	30	55	mV	
	Input current	IIN1	2	IN1 = 12.7 V, IN2 = 12.6 V		—	17	34	μA	MB3813A
		IIN1	2	IN1 = 8.5 V, IN2 = 8.4 V		—	17	34	μA	MB3833A
		IIN1	2	IN1 = 4.3 V, IN2 = 4.2 V		—	17	34	μA	MB3843
	In-phase input voltage range	V_{CM}	2	—		0	—	V_{CC}	V	
	Voltage gain	A_v	2	IN1 = 12.7 V, IN2 = 12.6 V		21	25	29	V/V	MB3813A
		A_v	2	IN1 = 8.5 V, IN2 = 8.4 V		21	25	29	V/V	MB3833A
A_v		2	IN1 = 4.3 V, IN2 = 4.2 V		21	25	29	V/V	MB3843	
PWM comparator block (PWM)	Threshold voltage	VT0	15	Duty cycle = 0%		0.9	1.0	—	V	
		VT100	15	Duty cycle = 100%		—	2.0	2.1	V	
Output block (OUT)	ON resistance	R_{ON}	15	OUT = -30 mA		—	12	18	Ω	
	Output voltage	V_{OL}	15	OUT = 100 mA		—	1.0	1.4	V	
	Standby leak current	I_{LO}	15	$V_{CC} = 18\text{ V}$, OUT = 18 V, CTL = 0 V		-1.0	—	1.0	μA	
Power supply control block (CTL)	CTL input voltage	V_{ON}	7	Active mode		2.0	—	18	V	
	Standby mode	V_{OFF}	7	Standby mode		0	—	0.8	V	
	Input current	I_{IH}	7	CTL = 5 V		—	100	200	μA	
		I_{IL}	7	CTL = 0 V		-1.0	—	1.0	μA	

(Continued)

MB3813A/MB3833A/MB3843

(Continued)

($V_{CC} = V_{in1} = +16\text{ V}$, $V_{SEL} = 0\text{ V}$, $T_a = +25^\circ\text{C}$)

Parameter		Symbol	Pinno.	Condition	Value			Unit	Remarks
					Min.	Typ.	Max.		
Output voltage selection block (SEL)	SEL voltage	V_{ON}	10	12.3 V output mode	2.0	—	18	V	MB3813A
		V_{ON}	10	8.2 V output mode	2.0	—	18	V	MB3833A
		V_{ON}	10	4.1 V output mode	2.0	—	18	V	MB3843
	SEL voltage	V_{OFF}	10	12.6 V output mode	0	—	0.8	V	MB3813A
		V_{OFF}	10	8.4 V output mode	0	—	0.8	V	MB3833A
		V_{OFF}	10	4.2 V output mode	0	—	0.8	V	MB3843
	Input current	I_{IH}	10	CTL = 5 V	-1.0	—	1.0	μA	
I_{IL}		10	CTL = 0 V	-1.0	—	1.0	μA		
Input current when power supply OFF	I_{IL}	10	$V_{CC} = 0\text{ V}$, SEL = 5 V	-1.0	—	1.0	μA		
General	Standby current	I_{CCS}	14	CTL = 0 V	—	260	390	μA	
	Power supply current	I_{CC}	14	at output voltage "H" level	—	3.4	5.4	mA	

MB3813A/MB3833A/MB3843

■ TYPICAL CHARACTERISTICS

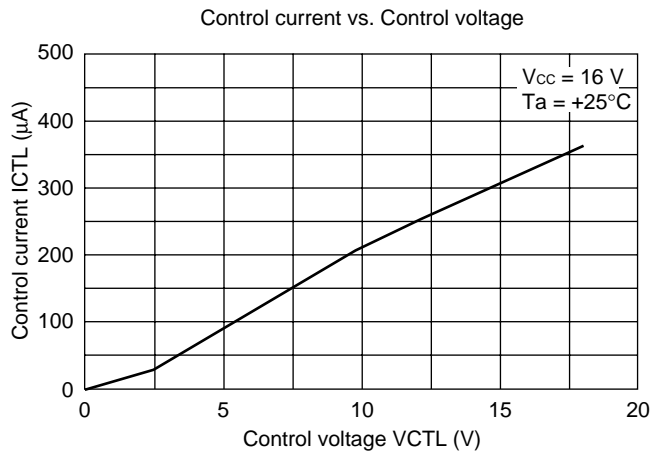
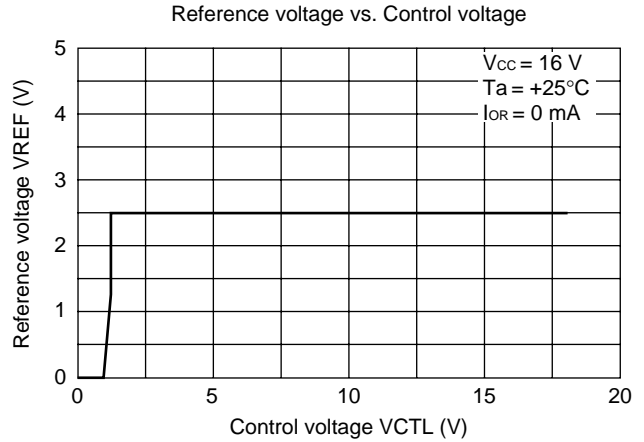
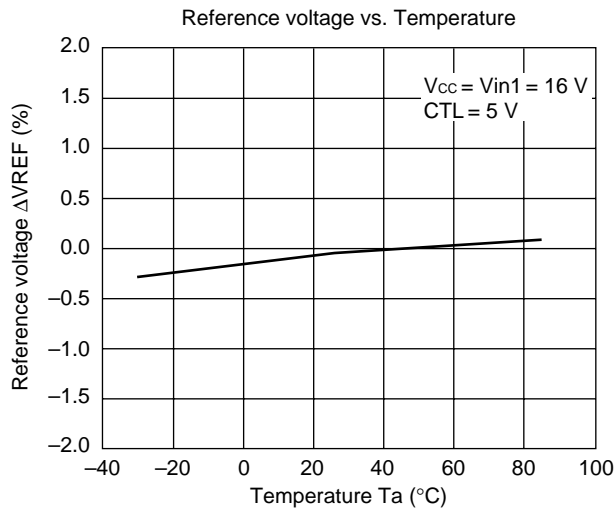
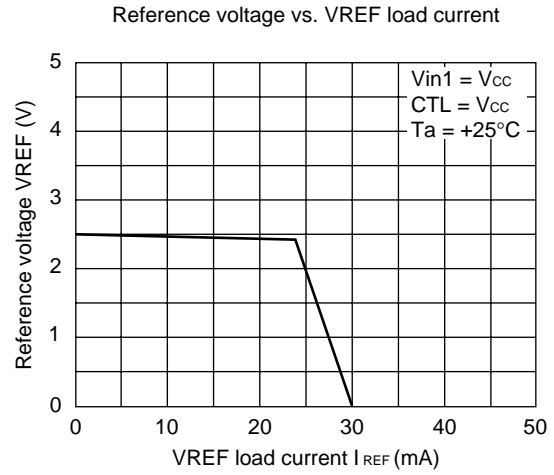
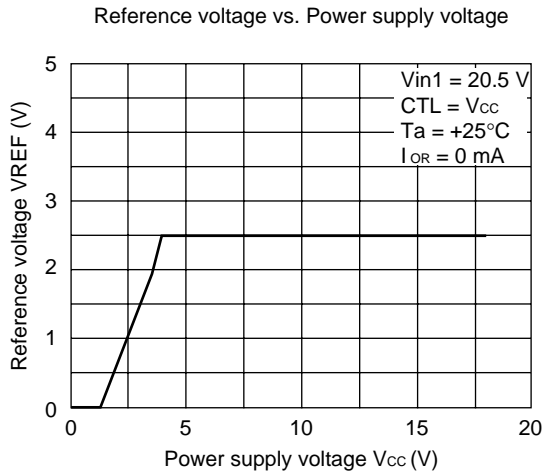

(Continued)

MB3813A/MB3833A/MB3843

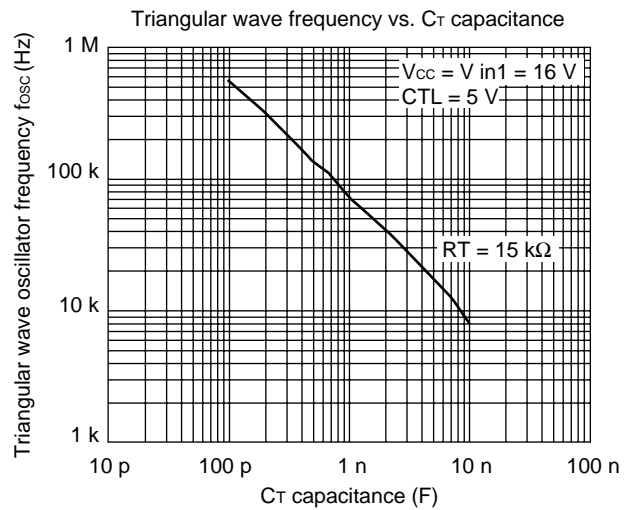
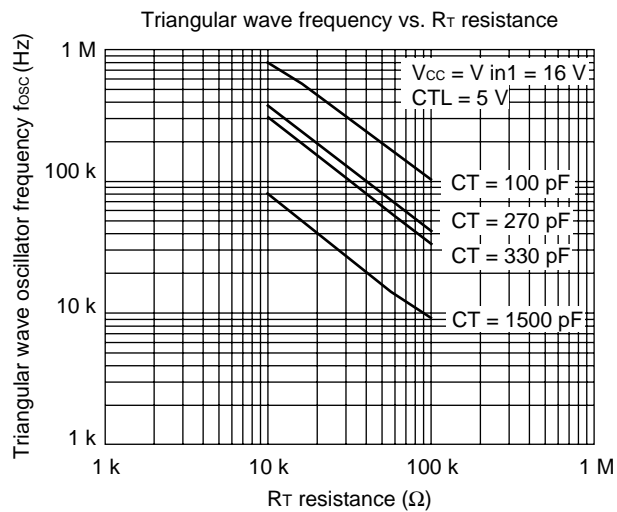
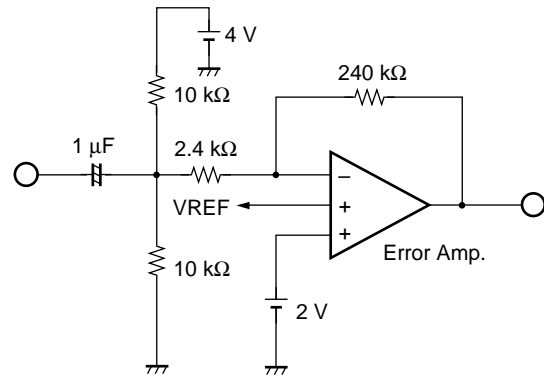
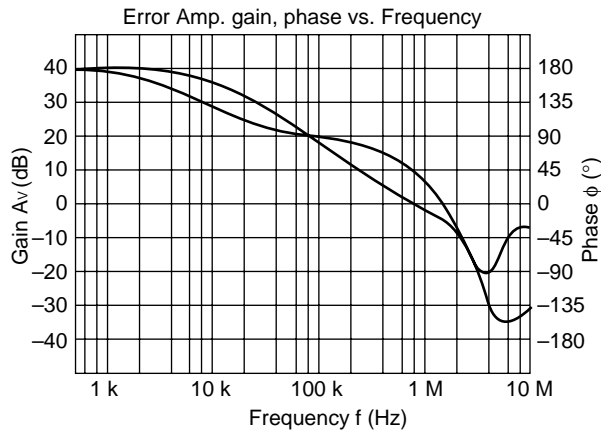
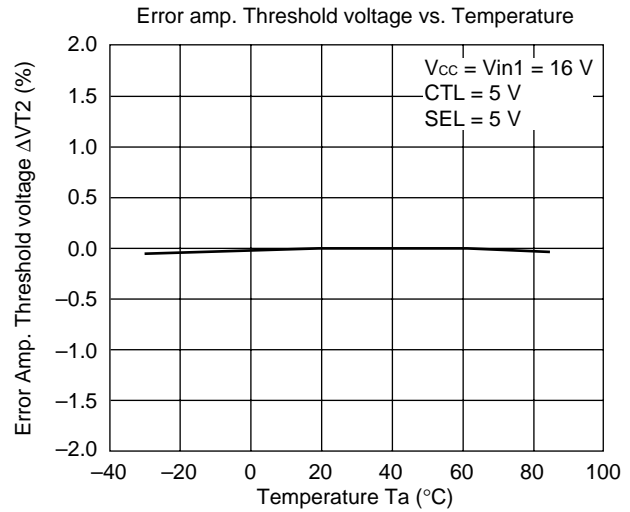
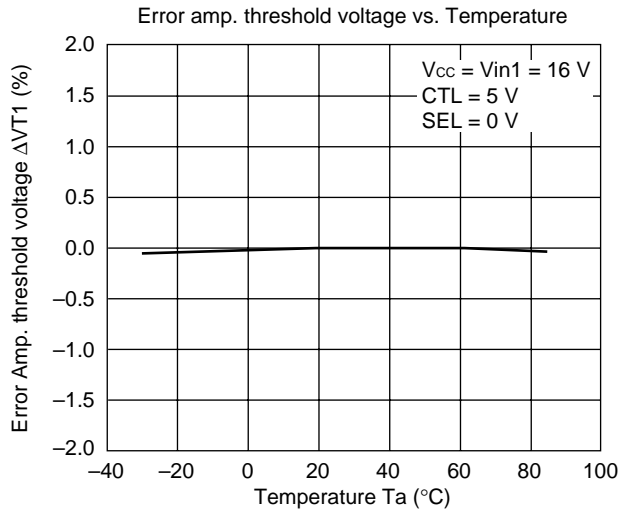

(Continued)

MB3813A/MB3833A/MB3843

(Continued)

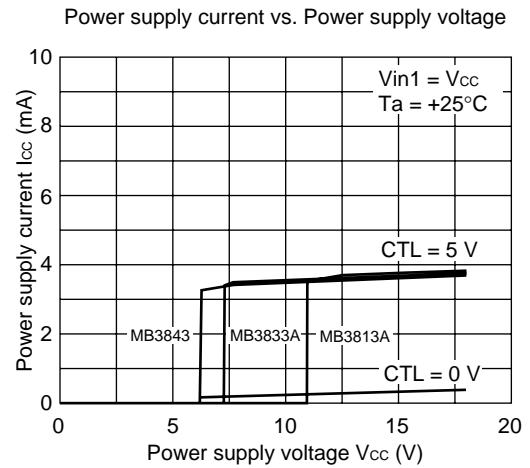
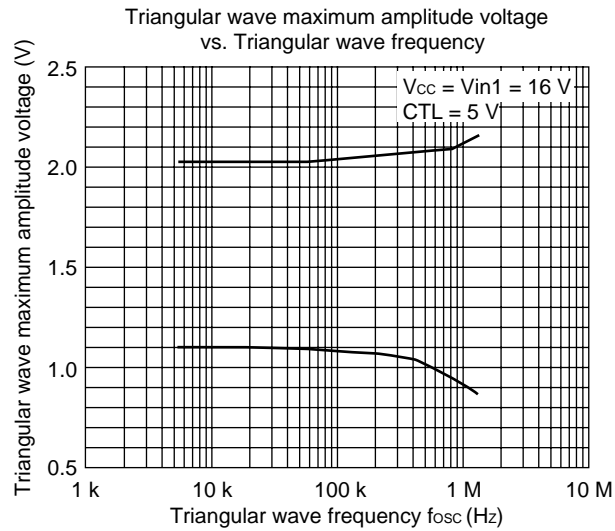
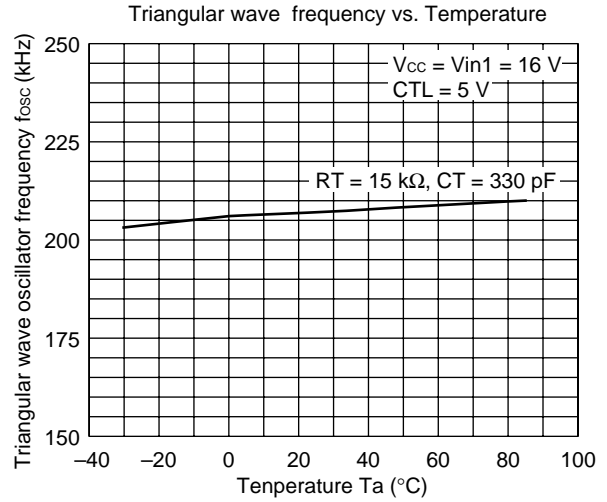
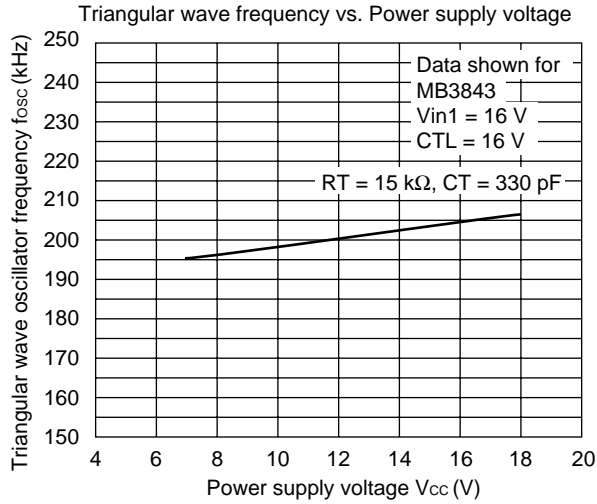

MB3813A/MB3833A/MB3843

■ FUNCTIONAL DESCRIPTION

1. Switching Regulator Block

(1) Reference voltage circuit (Ref)

The reference voltage circuit uses the voltage supply from the V_{CC} pin (pin 14) to generate a temperature compensated, stable voltage (≈ 2.50 V) for use as the reference voltage for the internal circuits of the IC chip.

It is also possible to supply a reference voltage output of up to 1 mA to external circuits through the VREF pin (pin 9).

(2) Triangular wave oscillator circuit (OSC)

By connecting the CT pin (pin 13) and RT pin (pin 12) respectively to a capacitance and resistance for timing, a triangular oscillator waveform can be generated.

The triangular wave is input to the PWM comparator circuits on the IC. At the same time, it can also be supplied to an external device from the CT terminal.

(3) Error amplifier circuit (Error Amp.1)

The error amplifier circuit is used to detect the output voltage from the switching regulator and produces the PWM control signal. No external resistance is required at the error amplifier inversion input pin, because the output voltage setting resistance is connected within the IC. The output voltage settings are defined as: MB3813A 12.6 V/12.3 V, MB3833A 8.4 V/8.2 V, MB3843 4.2 V/4.1 V, the optimum levels respectively for use with 3-cell, 2-cell and 1-cell lithium-ion batteries.

Also, by connecting feedback resistance and capacitance between the error amplifier FB pin (pin 6) and -IN pin (pin 5), it is possible to set the desired level of loop gain to provide stabilized phase compensation to the system.

The CS pin (pin 11) can be connected to a soft start capacitor to prevent current surges at startup. The soft start is detected by the error amplifier, which provides a constant soft start time independent of output load.

(4) Current detector amplifier circuit (Current Amp.)

The current detector amplifier provides $25 \times$ amplification of the voltage drop between the two ends of the output sensor resistor (RS) in the switching regulator, that occurs due to the flow of the charging current. This voltage drop is compared to the voltage at the Vin2 pin (pin 8) in the next stage error amplifier circuit (Error Amp.2), and used to control the charging current.

(5) Power supply control circuit (CTL)

An "L" level signal input to the CTL pin (pin 7) places the IC in standby mode. In standby mode, all circuits other than input detection circuits are switched off.

(6) PWM comparator circuit (PMW Comp.)

This is a voltage-pulse width conversion circuit that controls the output duty of the error amplifier circuits (Error Amp.1, 2) according to the output voltage.

During intervals when the triangular waveform is lower than the error amplifier output voltage, an external output transistor is switched on.

(7) Output circuit (OUT)

The output circuit uses a totem-pole configuration and is capable of driving an external P-ch. MOS FET device.

MB3813A/MB3833A/MB3843

2. Output Voltage Switching Function

The SEL pin (pin 10) is capable of output levels of 4.2 V or 4.1 V per battery cell.

- **Output voltage settings by model**

SEL pin voltage level	Model	Output voltage	Units
L	MB3813A	12.6	V
H		12.3	V
L	MB3833A	8.4	V
H		8.2	V
L	MB3843	4.2	V
H		4.1	V

3. Protection Functions

(1) Input voltage detector circuit (VIDET)

When the input voltage supply from the AC adapter or other source detected at the Vin1 pin (pin 1) falls below 11 V (MB3813A), or below 7.3 V (MB3833A), or below 6.3 V (MB3843), the internal reference voltage circuit switches off.

(2) Under voltage lockout circuit (UVLO)

Power surges at power-on, or momentary under-voltage situations can cause abnormal operation in a control IC, which may lead to damage or deterioration in systems. This circuit prevents abnormal operation during times of low voltage by using the supply voltage to detect the level of the internal reference voltage, and switching off the external output transistor to create a 100% rest interval. Once the supply voltage recovers to a level above the threshold voltage of the under voltage lockout circuit, operation is restored.

MB3813A/MB3833A/MB3843

■ METHOD OF SETTING THE CHARGING CURRENT

The charging current level (output limit current level) is set at the Vin2 pin (pin 8).

Charging current level (output limit current level) :

$$I_L \text{ (MAX) [A]} = \frac{V_{in2} \text{ (V)}}{25 \times R_S \text{ (\Omega)}} \quad R_S: \text{ output sensing resistance}$$

■ METHOD OF SETTING THE SOFT START TIME

- At start up, the capacitor (Cs) connected to the CS pin (pin 11) begins charging. The error amplifier compares the soft start setting voltage, which is proportional to the CS pin voltage, to the output feedback voltage and produces a soft start by varying the ON duty at the OUT pin (pin 15). The soft start time can be determined by the formula below.
- Because the CS pin voltage is input to the error amplifier, the soft start time setting is not dependent on the output current value.

Soft start time (time to output setting voltage VD) :

$$t_s \text{ [s]} = 2.5 \times C_S \text{ [\mu F]}$$

■ ERROR AMP. BLOCK OVERTHROTT PROTECTION CIRCUIT

This built-in circuit responds to rapid fluctuations in charging current such as can occur when inserting or removing a chargeable battery, by clamping an inverted input signal (-IN1 or -IN2) from the error amps (Error Amp.1 or Error Amp.2) to suppress changes in output voltage.

■ CTL, SEL PIN EQUIVALENT CIRCUITS

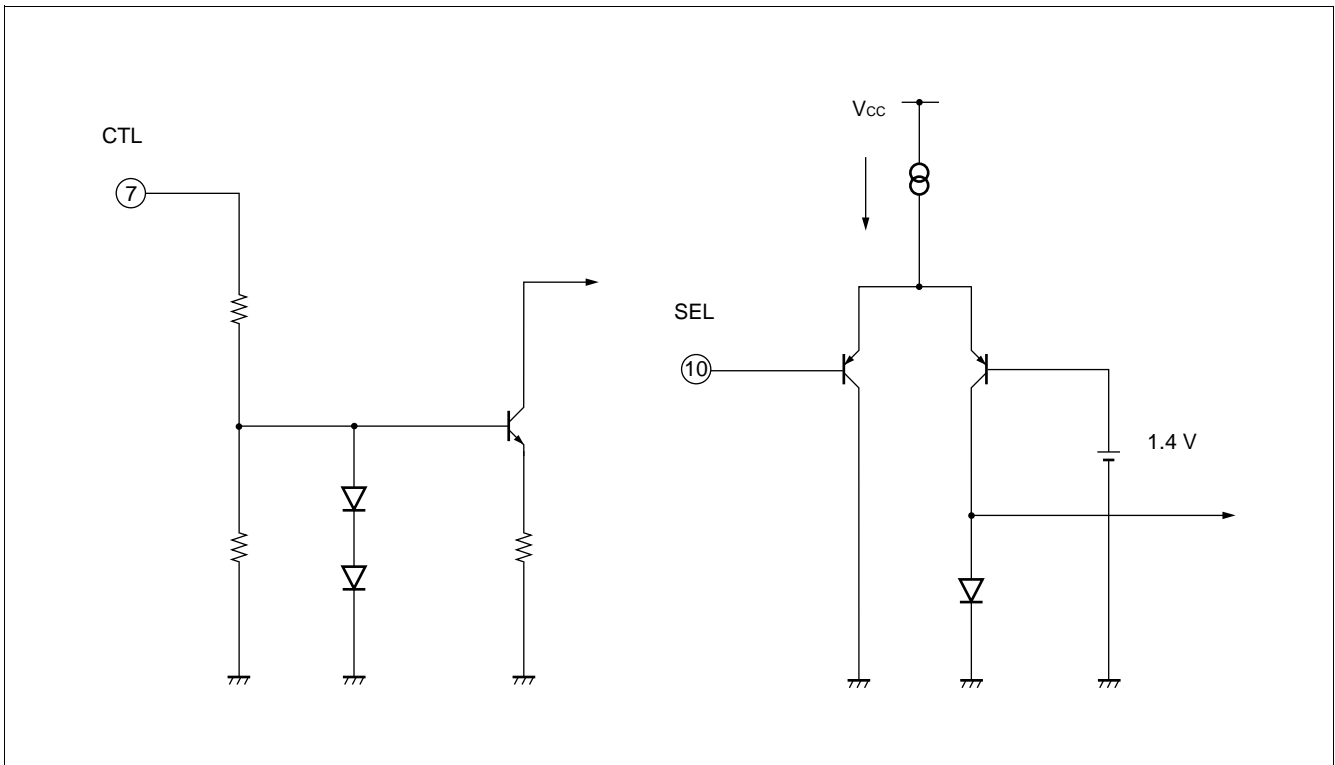

MB3813A/MB3833A/MB3843

APPLICATION EXAMPLE

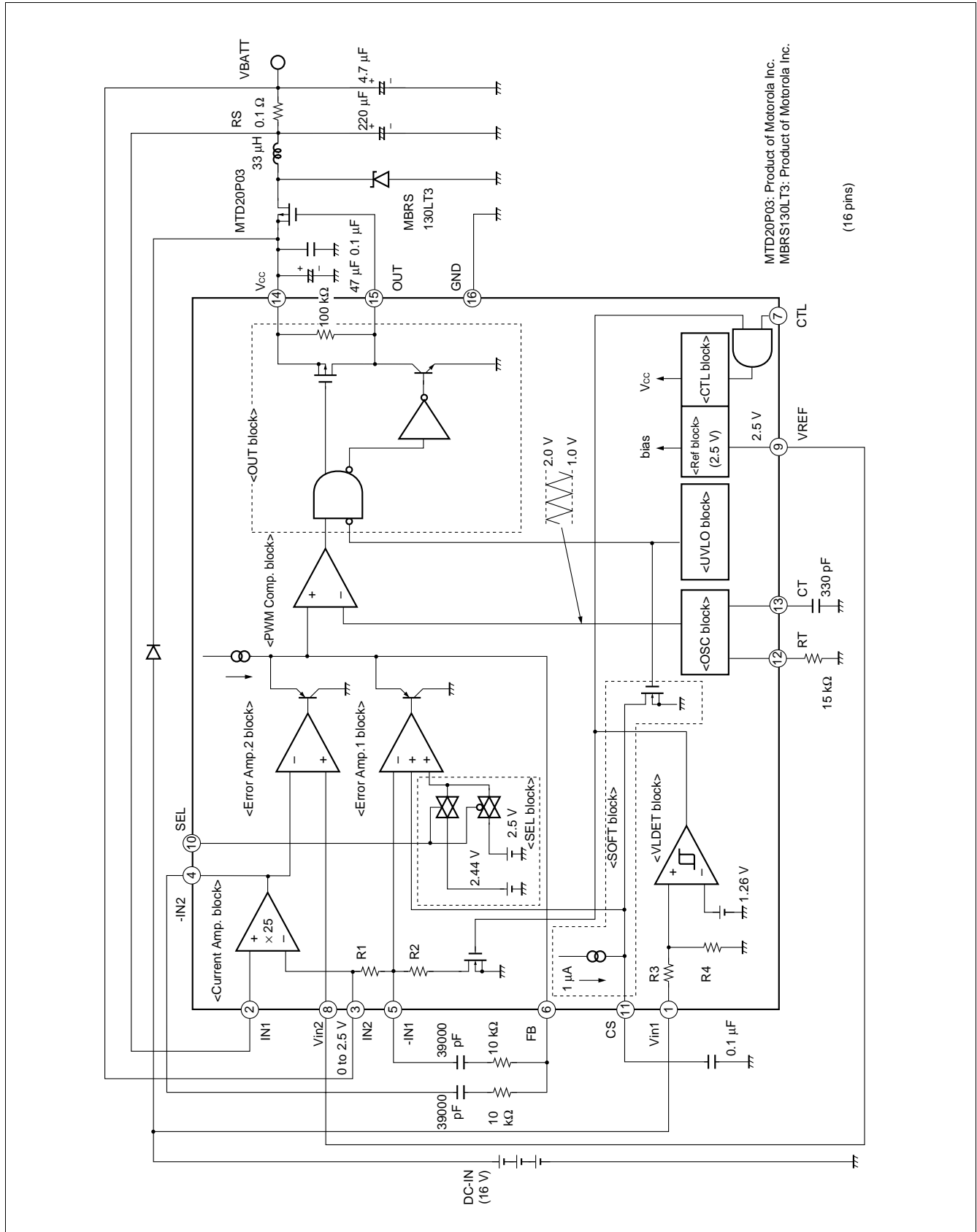

MB3813A/MB3833A/MB3843

■ REFERENCE DATA

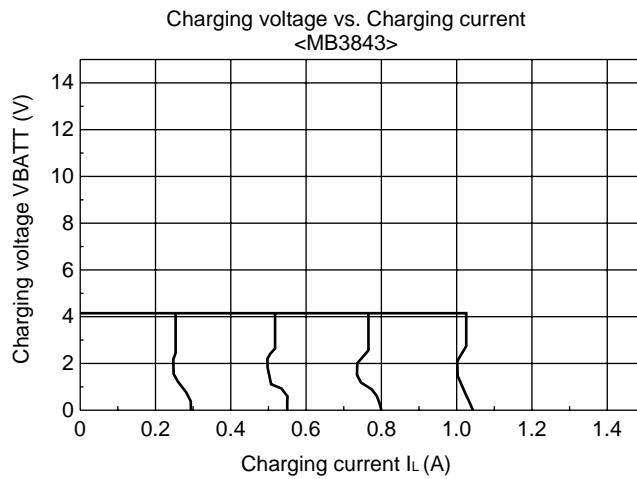
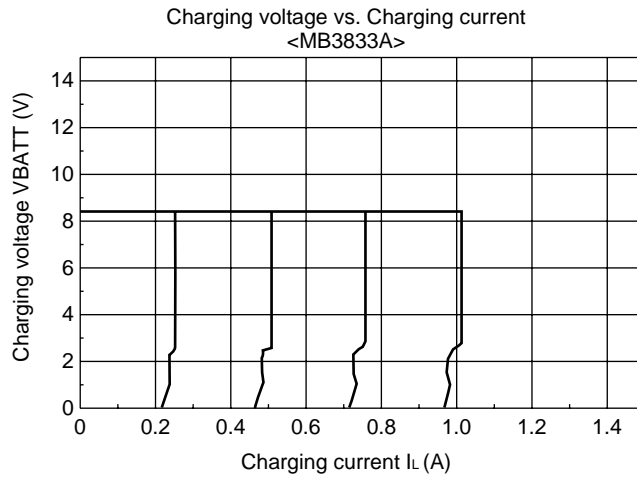
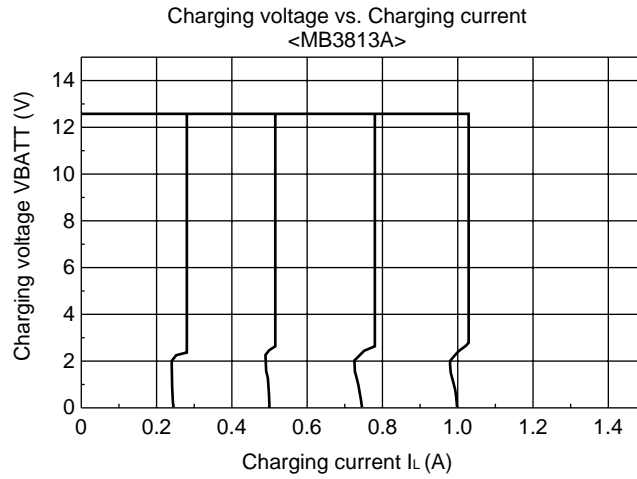

(Continued)

MB3813A/MB3833A/MB3843

(Continued)

Soft start operation waveforms

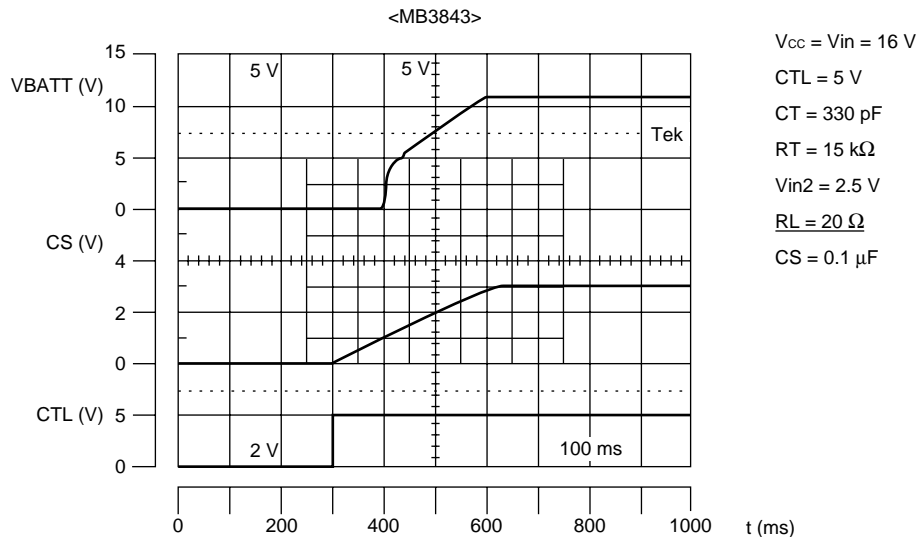
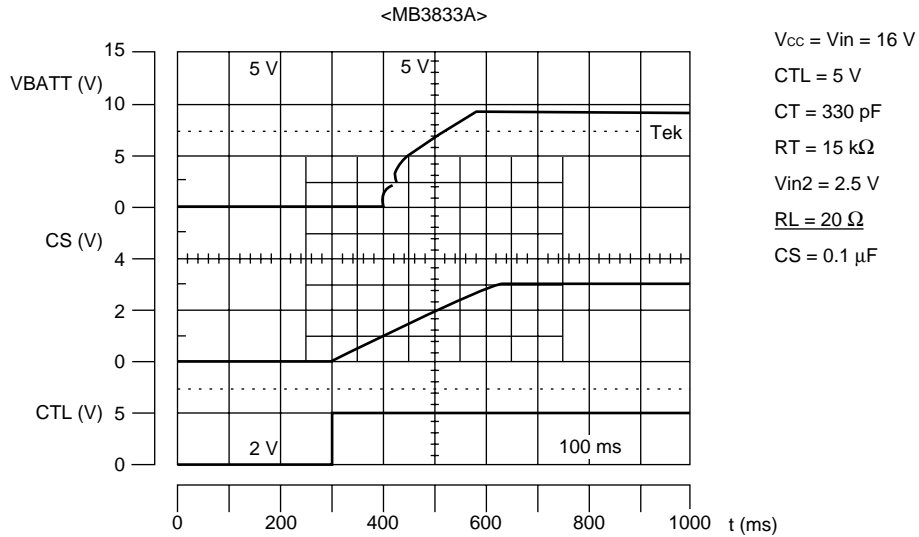
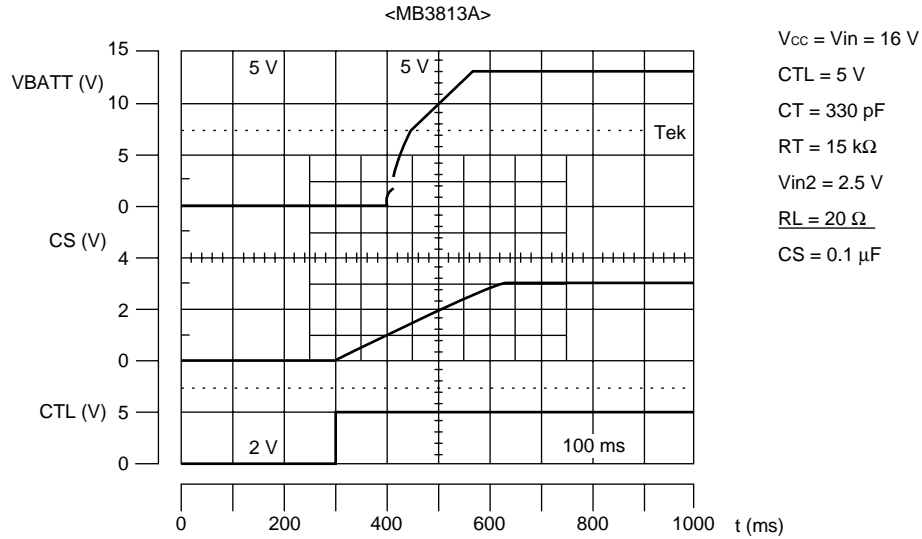

MB3813A/MB3833A/MB3843

■ USAGE PRECAUTION

- Printed circuit board ground lines should be designed in consideration of common impedance values.
- Observe precautions against static electricity.
 - Containers in which semiconductors are placed should either be protected against static electricity, or be of conductive material.
 - After devices are mounted, use conductive bags or conductive containers when storing or transporting printed circuit boards.
 - Working surfaces, tools and instruments should be properly rounded.
 - Workers should be grounded by a ground line with 250 k Ω to 1 M Ω resistance in series between the worker and ground.
- Do not apply negative voltages.

The use of negative voltages below -0.3 V may create parasitic transistors on LSI lines, which can cause abnormal operation.

■ ORDERING INFORMATION

Part number	Package	Remarks
MB3813APFV MB3833APFV MB3843PFV	16-pin plastic SSOP (FPT-16P-M05)	

MB3813A/MB3833A/MB3843

■ PACKAGE DIMENSION

16-pin plastic SSOP
(FPT-16P-M05)

* : These dimensions do not include resin protrusion.

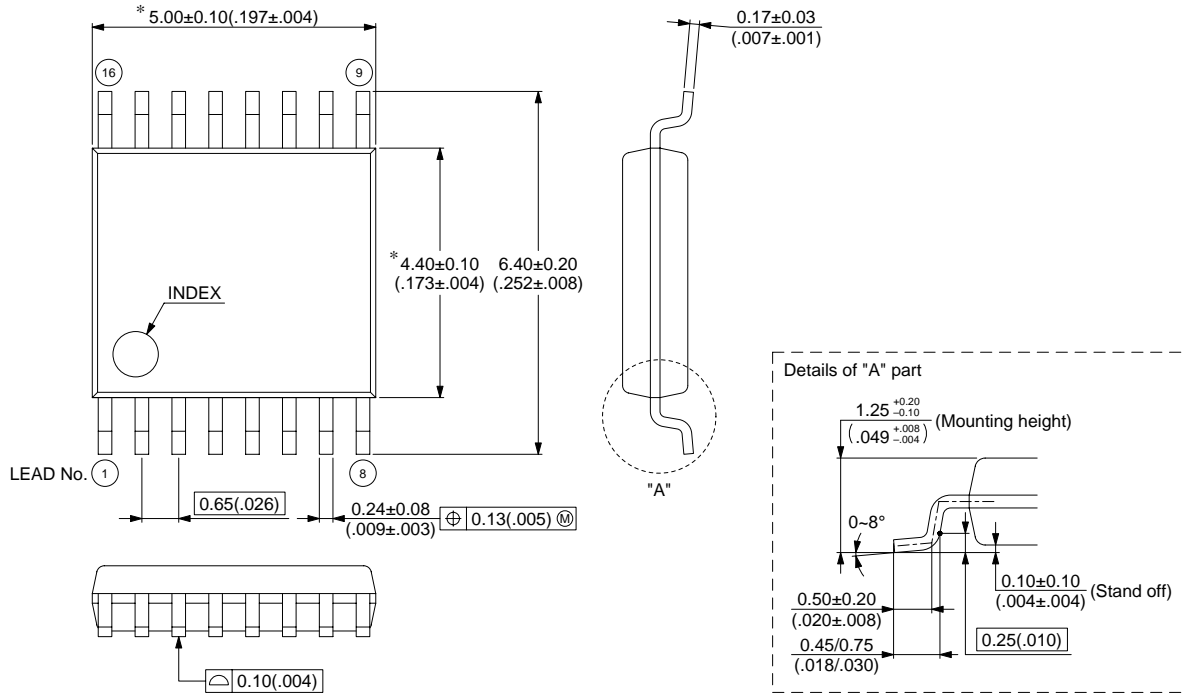

MB3813A/MB3833A/MB3843

FUJITSU LIMITED

For further information please contact:

Japan

FUJITSU LIMITED
Corporate Global Business Support Division
Electronic Devices
KAWASAKI PLANT, 4-1-1, Kamikodanaka,
Nakahara-ku, Kawasaki-shi,
Kanagawa 211-8588, Japan
Tel: +81-44-754-3763
Fax: +81-44-754-3329

<http://www.fujitsu.co.jp/>

North and South America

FUJITSU MICROELECTRONICS, INC.
3545 North First Street,
San Jose, CA 95134-1804, U.S.A.
Tel: +1-408-922-9000
Fax: +1-408-922-9179

Customer Response Center
Mon. - Fri.: 7 am - 5 pm (PST)
Tel: +1-800-866-8608
Fax: +1-408-922-9179

<http://www.fujitsumicro.com/>

Europe

FUJITSU MICROELECTRONICS EUROPE GmbH
Am Siebenstein 6-10,
D-63303 Dreieich-Buchsschlag,
Germany
Tel: +49-6103-690-0
Fax: +49-6103-690-122

<http://www.fujitsu-fme.com/>

Asia Pacific

FUJITSU MICROELECTRONICS ASIA PTE. LTD.
#05-08, 151 Lorong Chuan,
New Tech Park,
Singapore 556741
Tel: +65-281-0770
Fax: +65-281-0220

<http://www.fmap.com.sg/>

Korea

FUJITSU MICROELECTRONICS KOREA LTD.
1702 KOSMO TOWER, 1002 Daechi-Dong,
Kangnam-Gu, Seoul 135-280
Korea
Tel: +82-2-3484-7100
Fax: +82-2-3484-7111

All Rights Reserved.

The contents of this document are subject to change without notice. Customers are advised to consult with FUJITSU sales representatives before ordering.

The information and circuit diagrams in this document are presented as examples of semiconductor device applications, and are not intended to be incorporated in devices for actual use. Also, FUJITSU is unable to assume responsibility for infringement of any patent rights or other rights of third parties arising from the use of this information or circuit diagrams.

The contents of this document may not be reproduced or copied without the permission of FUJITSU LIMITED.

FUJITSU semiconductor devices are intended for use in standard applications (computers, office automation and other office equipments, industrial, communications, and measurement equipments, personal or household devices, etc.).

CAUTION:

Customers considering the use of our products in special applications where failure or abnormal operation may directly affect human lives or cause physical injury or property damage, or where extremely high levels of reliability are demanded (such as aerospace systems, atomic energy controls, sea floor repeaters, vehicle operating controls, medical devices for life support, etc.) are requested to consult with FUJITSU sales representatives before such use. The company will not be responsible for damages arising from such use without prior approval.

Any semiconductor devices have inherently a certain rate of failure. You must protect against injury, damage or loss from such failures by incorporating safety design measures into your facility and equipment such as redundancy, fire protection, and prevention of over-current levels and other abnormal operating conditions.

If any products described in this document represent goods or technologies subject to certain restrictions on export under the Foreign Exchange and Foreign Trade Control Law of Japan, the prior authorization by Japanese government should be required for export of those products from Japan.