



Micro Commercial Components  
 21201 Itasca Street Chatsworth  
 CA 91311  
 Phone: (818) 701-4933  
 Fax: (818) 701-4939

# MBR12020 THRU MBR120100

## 120 Amp Schottky Barrier Rectifier 20 to 100 Volts

### Features

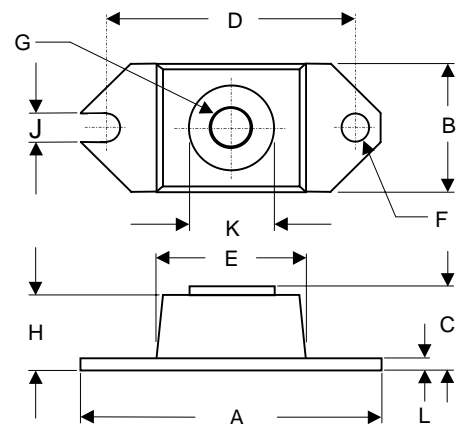
- Metal of siliconrectifier, majonty carrier conducton
- Guard ring for transient protection
- Low power loss high efficiency
- High surge capacity, High current capability

### Maximum Ratings

- Operating Junction Temperature: -55°C to +175°C
- Storage Temperature: -55°C to +175°C
- Typical Thermal Resistance per leg 0.8°C/W Junction to Case

MCC Part Number	Maximum Recurrent Peak Reverse Voltage	Maximum RMS Voltage	Maximum DC Blocking Voltage
MBR12020	20V	14V	20V
MBR12030	30V	21V	30V
MBR12035	35V	24.5V	35V
MBR12040	40V	28V	40V
MBR12045	45V	31.5V	45V
MBR12060	60V	42V	60V
MBR12080	80V	56V	80V
MBR120100	100V	70V	100V

### HALF PACK



### Electrical Characteristics @ 25°C Unless Otherwise Specified

Average Forward Current	$I_{F(AV)}$	120 A	$T_C = 136^\circ\text{C}$
Peak Forward Surge Current	$I_{FSM}$	2000A	8.3ms, half sine
Maximum Instantaneous Forward Voltage MBR12020-12045 MBR12060 MBR12080-120100	$V_F$	.63 V .75 V .84 V	$I_{FM} = 120.0\text{A};$ $T_J = 25^\circ\text{C}$
Maximum DC Reverse Current At Rated DC Blocking Voltage	$I_R$	4mA 75mA	$T_J = 25^\circ\text{C}$ $T_J = 125^\circ\text{C}$
Typical Junction Capacitance MBR12020-12045 MBR12060 MBR12080-120100	$C_J$	4600pF 4300pF 3000pF	Measured at 1.0MHz, $V_R=5.0\text{V}$

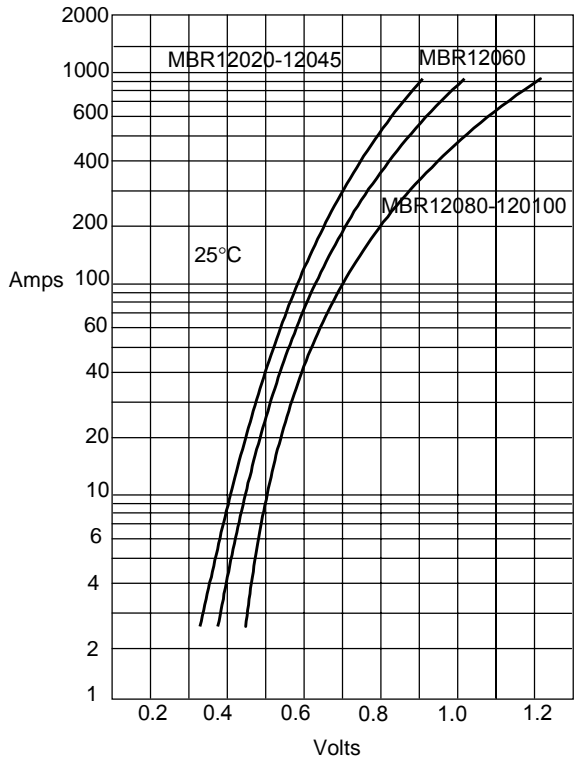
DIM	INCHES		MM		NOTE
	MIN	MAX	MIN	MAX	
A	1.515	1.560	38.48	39.62	
B	.725	.775	18.42	19.69	
C	.595	.625	15.11	15.88	
D	1.182	1.192	30.02	30.28	
E	.745	.755	18.92	19.18	
F	.152	.160	3.86	4.06	∅
G	1/4 - .20		UNC - .2B		
H	.540	.580	13.72	14.73	
J	.15	.160	3.96	4.06	
K	.495	.505	12.57	12.83	∅
L	.120	.130	3.05	3.30	

\*Pulse Test: Pulse Width 300µsec, Duty Cycle 2%

# MBR12020 thru MBR120100

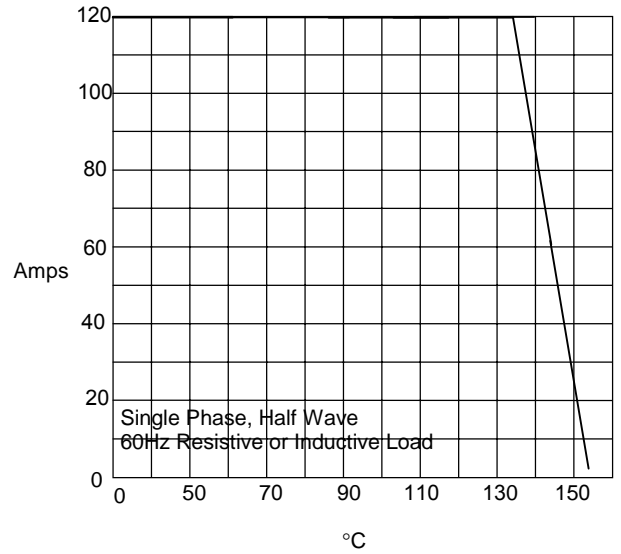


Figure 1  
Typical Forward Characteristics



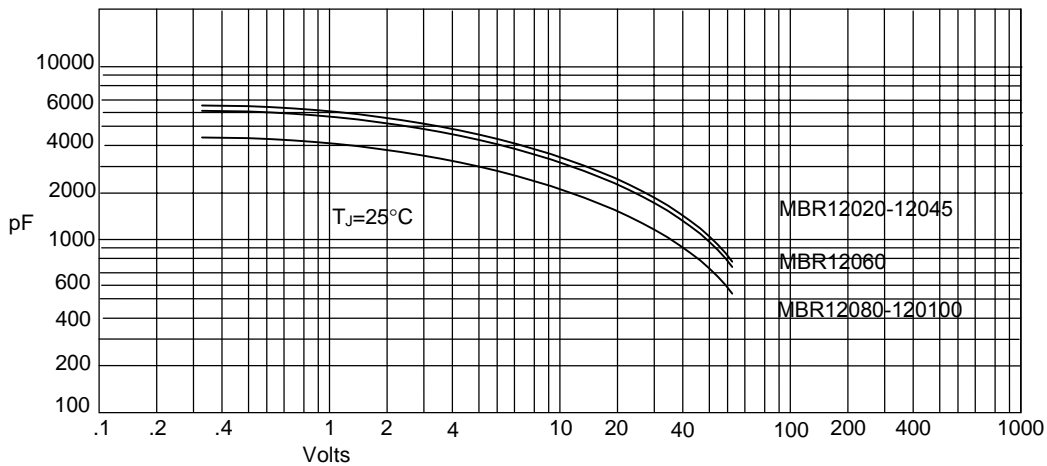
Instantaneous Forward Current - Amperes versus  
Instantaneous Forward Voltage - Volts

Figure 2  
Forward Derating Curve



Average Forward Rectified Current - Amperes versus  
Ambient Temperature - °C

Figure 3  
Junction Capacitance



Junction Capacitance - pF versus  
Reverse Voltage - Volts

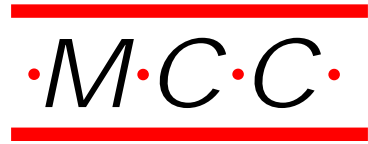
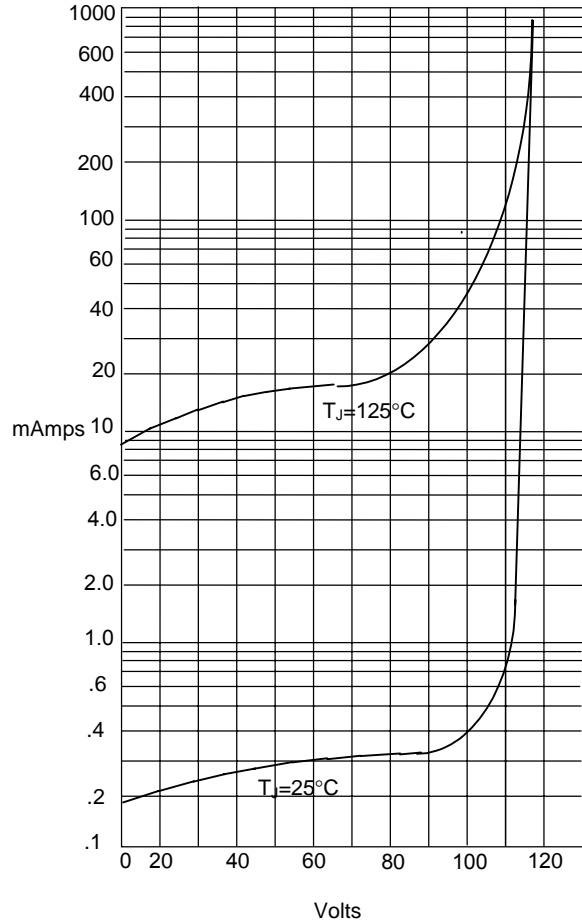
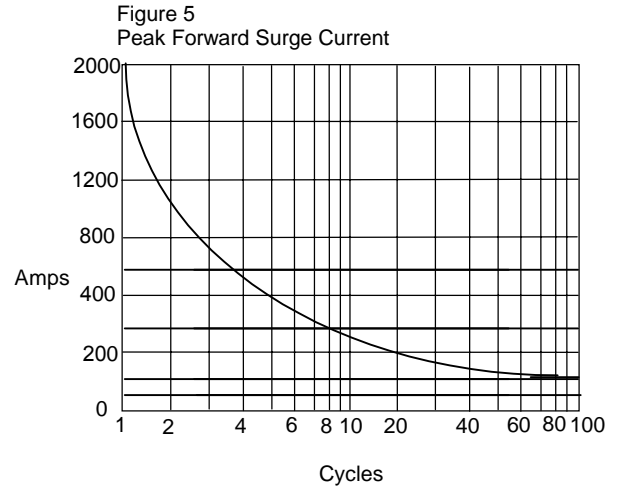


Figure 4  
Typical Reverse Characteristics



Instantaneous Reverse Leakage Current - MicroAmperes *versus*  
Percent Of Rated Peak Reverse Voltage - Volts



Peak Forward Surge Current - Amperes *versus*  
Number Of Cycles At 60Hz - Cycles

Copyright © Each Manufacturing Company.

All Datasheets cannot be modified without permission.

This datasheet has been download from :

[www.AllDataSheet.com](http://www.AllDataSheet.com)

100% Free DataSheet Search Site.

Free Download.

No Register.

Fast Search System.

[www.AllDataSheet.com](http://www.AllDataSheet.com)