

MBR2035CT THRU MBR2060CT

SCHOTTKY RECTIFIER

Reverse Voltage - 35 to 60 Volts Forward Current - 20.0 Amperes

TO-220AB

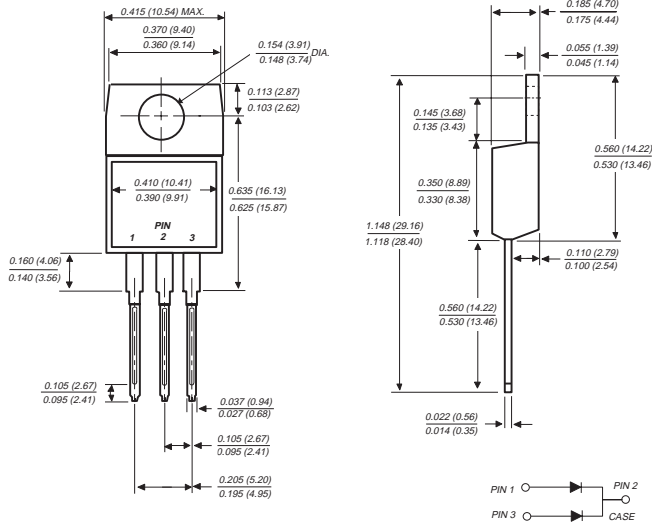

Dimensions in inches and (millimeters)

FEATURES

- ◆ Plastic package has Underwriters Laboratory Flammability Classification 94V-0
- ◆ Dual rectifier construction, positive center tap
- ◆ Metal silicon junction, majority carrier conduction
- ◆ Low power loss, high efficiency
- ◆ High current capability, low forward voltage drop
- ◆ High surge capability
- ◆ Guardring for overvoltage protection
- ◆ For use in low voltage, high frequency inverters, free wheeling, and polarity protection applications
- ◆ High temperature soldering guaranteed: 250°C/10 seconds, 0.25" (6.35mm) from case



MECHANICAL DATA

Case: JEDEC TO-220AB molded plastic
Terminals: Leads solderable per MIL-STD-750, Method 2026
Polarity: As marked
Mounting Position: Any
Mounting Torque: 5 in. - lbs.max.
Weight: 0.08 ounce, 2.24 grams

MAXIMUM RATINGS AND ELECTRICAL CHARACTERISTICS

Ratings at 25°C ambient temperature unless otherwise specified.

	SYMBOLS	MBR2035CT	MBR2045CT	MBR2050CT	MBR2060CT	UNITS
Maximum repetitive peak reverse voltage	V_{RRM}	35	45	50	60	Volts
Maximum working peak reverse voltage	V_{RWM}	35	45	50	60	Volts
Maximum DC blocking voltage	V_{DC}	35	45	50	60	Volts
Maximum average forward rectified current at $T_C=135^\circ\text{C}$	$I_{(AV)}$	20.0				Amps
Peak repetitive forward current per leg at $T_C=135^\circ\text{C}$ (rated V_R , sq. wave 2.0 KHz)	I_{FRM}	20.0				Amps
Peak forward surge current 8.3ms single half sine-wave superimposed on rated load (JEDEC Method)	I_{FSM}	150.0				Amps
Peak repetitive reverse surge current (NOTE 1)	I_{RRM}	1.0		0.5		Amps
Maximum instantaneous forward voltage per leg at (NOTE 2)	V_F			0.80		Volts
$I_F=10\text{A}, T_C=25^\circ\text{C}$		0.57		0.70		
$I_F=10\text{A}, T_C=125^\circ\text{C}$		0.84		0.95		
$I_F=20\text{A}, T_C=25^\circ\text{C}$		0.72		0.85		
Maximum instantaneous reverse current at rated DC blocking voltage per leg	I_R			0.15		mA
$T_C=25^\circ\text{C}$ $T_C=125^\circ\text{C}$		0.1		150.0		
Voltage rate of change, (rated V_R)	dv/dt	10,000				V/ μs
Typical thermal resistance per leg (NOTE 3)	$R_{\theta JC}$	2.0				$^\circ\text{C}/\text{W}$
Operating junction temperature range	T_J	-65 to +150				$^\circ\text{C}$
Storage temperature range	T_{STG}	-65 to +175				$^\circ\text{C}$

NOTES:

- (1) 2.0 μs pulse width, $f=1.0\text{KHz}$
- (2) Pulse test: 300 μs pulse width, 1% duty cycle

RATINGS AND CHARACTERISTIC CURVES MBR2035CT THRU MBR2060CT

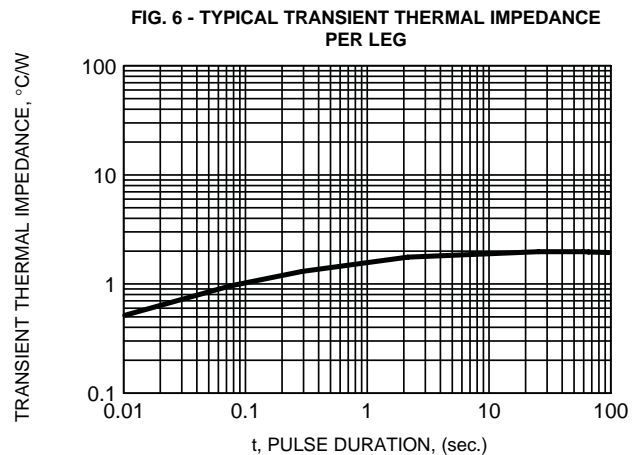
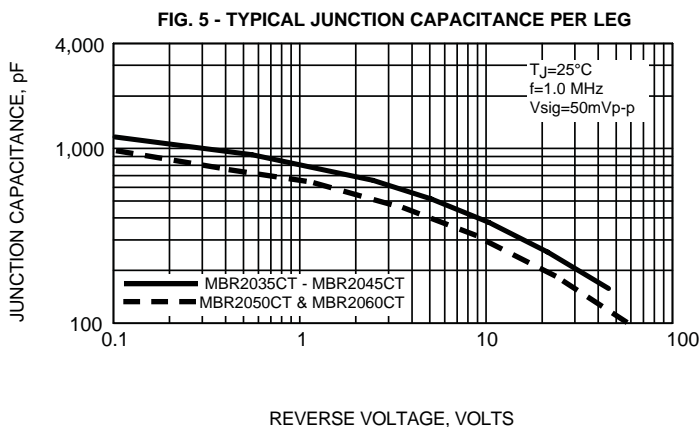
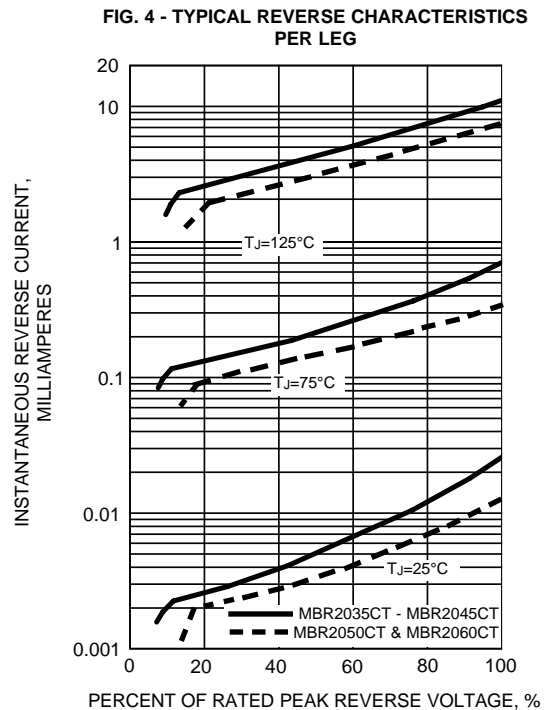
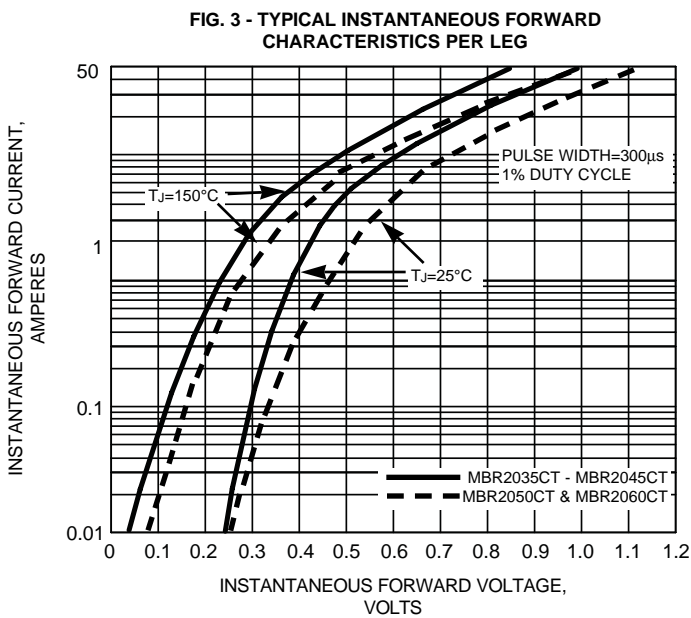
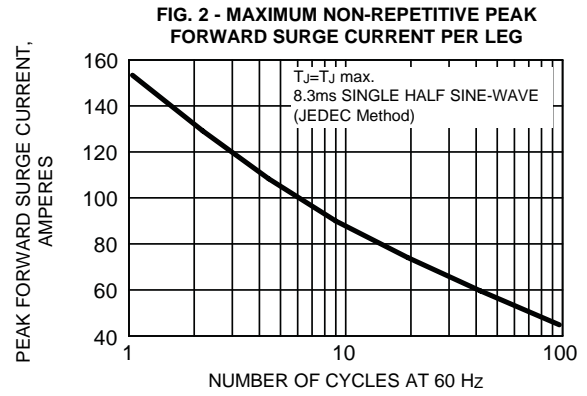
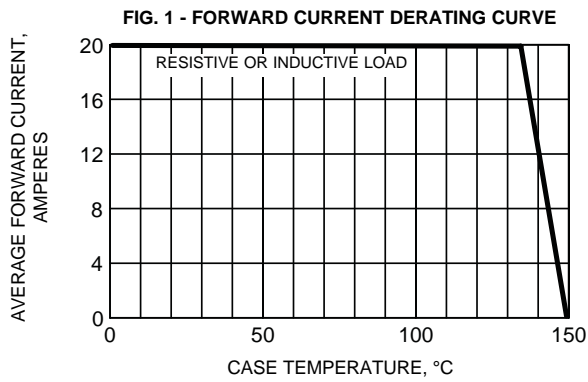

Copyright © Each Manufacturing Company.

All Datasheets cannot be modified without permission.

This datasheet has been download from :

www.AllDataSheet.com

100% Free DataSheet Search Site.

Free Download.

No Register.

Fast Search System.

www.AllDataSheet.com