

$I_{F(AV)} = 30\text{Amp}$
 $V_R = 35\text{-}45\text{V}$

Major Ratings and Characteristics

Characteristics	Values	Units
$I_{F(AV)}$ Rectangular waveform (Per Device)	30	A
I_{FRM} @ $T_C = 123^\circ\text{C}$ (Per Leg)	30	A
V_{RRM}	35-45	V
I_{FSM} @ $t_p = 5\ \mu\text{s}$ sine	1020	A
V_F @ 20Apk, $T_J = 125^\circ\text{C}$	0.6	V
T_J range	-65 to 150	$^\circ\text{C}$

Description/ Features

This center tap Schottky rectifier has been optimized for low reverse leakage at high temperature. The proprietary barrier technology allows for reliable operation up to 150° C junction temperature. Typical applications are in switching power supplies, converters, free-wheeling diodes, and reverse battery protection.

- 150° C T_J operation
- Center tap TO-220, D²Pak and TO-262 packages
- Low forward voltage drop
- High purity, high temperature epoxy encapsulation for enhanced mechanical strength and moisture resistance
- High frequency operation
- Guard ring for enhanced ruggedness and long term reliability
- Lead-Free ("PbF" suffix)

Case Styles

MBR30..CTPbF

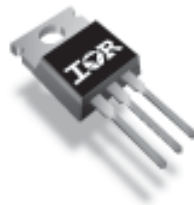

TO-220

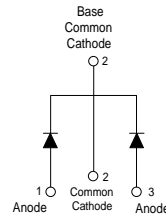

Voltage Ratings

Parameters	MBR3035CTPbF	MBR3045CTPbF
V_R Max. DC Reverse Voltage (V)	35	45
V_{RWM} Max. Working Peak Reverse Voltage (V)		

Absolute Maximum Ratings

Parameters	Values	Units	Conditions
$I_{F(AV)}$ Max. Average Forward Current (Per Leg) (Per Device)	15	A	@ $T_C = 123^\circ\text{C}$, (Rated V_R)
	30		
I_{FRM} Peak Repetitive Forward Current (Per Leg)	30	A	Rated V_R , square wave, 20kHz $T_C = 123^\circ\text{C}$
I_{FSM} Non Repetitive Peak Surge Current	1020	A	5 μs Sine or 3 μs Rect. pulse Following any rated load condition and with rated V_{RWM} applied Surge applied at rated load conditions halfwave, single phase, 60Hz
	200		
E_{AS} Non-Repetitive Avalanche Energy (Per Leg)	10	mJ	$T_J = 25^\circ\text{C}$, $I_{AS} = 2\text{Amps}$, $L = 5\text{mH}$
I_{AR} Repetitive Avalanche Current (Per Leg)	2	A	Current decaying linearly to zero in 1 μsec Frequency limited by T_J , max. $V_A = 1.5 \times V_R$ typical

Electrical Specifications

Parameters	Values	Units	Conditions	
V_{FM} Max. Forward Voltage Drop (1)	0.76	V	@ 30A	$T_J = 25^\circ\text{C}$
	0.6	V	@ 20A	$T_J = 125^\circ\text{C}$
	0.72	V	@ 30A	
I_{RM} Max. Instantaneous Reverse Current (1)	1	mA	$T_J = 25^\circ\text{C}$	Rated DC voltage
	100	mA	$T_J = 125^\circ\text{C}$	
$V_{F(TO)}$ Threshold Voltage	0.29	V	$T_J = T_J \text{ max.}$	
r_f Forward Slope Resistance	13.6	m Ω		
C_T Max. Junction Capacitance	800	pF	$V_R = 5V_{DC}$ (test signal range 100Khz to 1Mhz) 25°C	
L_S Typical Series Inductance	8.0	nH	Measured from top of terminal to mounting plane	
dv/dt Max. Voltage Rate of Change	10000	V/ μs	(Rated V_R)	

(1) Pulse Width < 300 μs , Duty Cycle <2%

Thermal-Mechanical Specifications

Parameters	Values	Units	Conditions
T_J Max. Junction Temperature Range	-65 to 150	$^\circ\text{C}$	
T_{stg} Max. Storage Temperature Range	-65 to 175	$^\circ\text{C}$	
R_{thJC} Max. Thermal Resistance Junction to Case (Per Leg)	1.5	$^\circ\text{C/W}$	DC operation
R_{thCS} Typical Thermal Resistance Case to Heatsink	0.50	$^\circ\text{C/W}$	Mounting surface, smooth and greased Only for TO-220
R_{thJA} Max. Thermal Resistance Junction to Ambient	50	$^\circ\text{C/W}$	DC operation For D ² Pak and TO-262
wt Approximate Weight	2 (0.07)	g (oz.)	
T Mounting Torque	Min.	6 (5)	Non-lubricated threads
	Max.	12 (10)	
Marking Device	MBR3045CT		

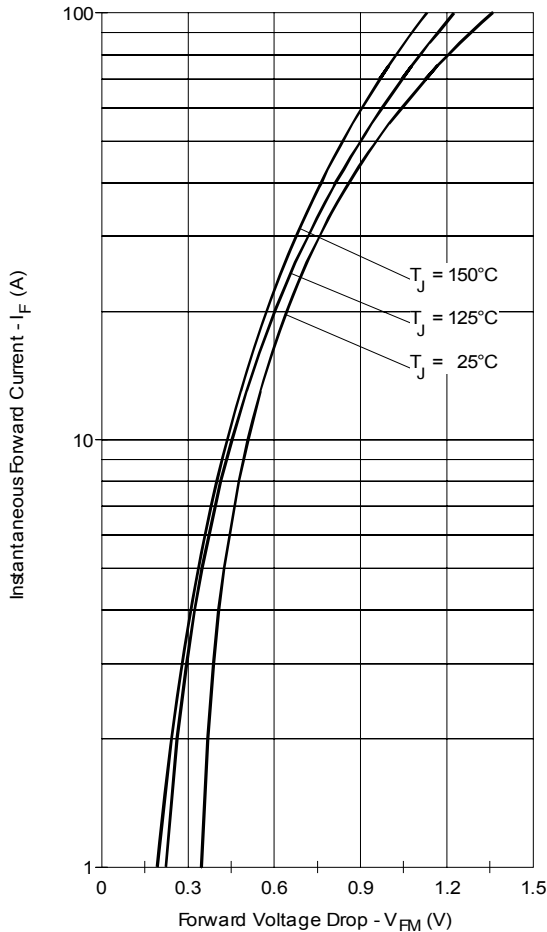

Fig. 1 - Max. Forward Voltage Drop Characteristics (Per Leg)

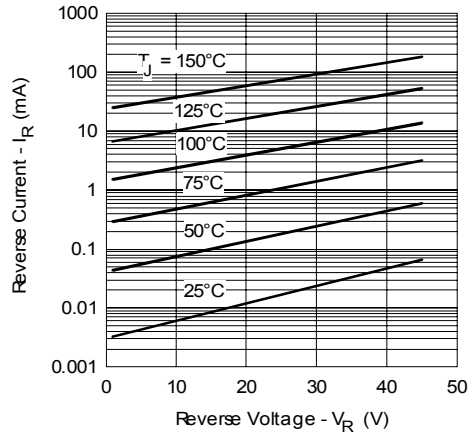

Fig. 2 - Typical Values Of Reverse Current Vs. Reverse Voltage (Per Leg)

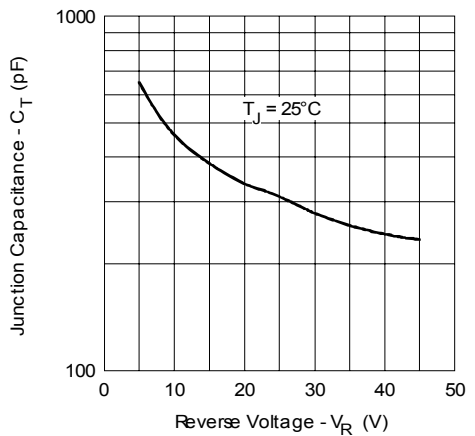

Fig. 3 - Typical Junction Capacitance Vs. Reverse Voltage (Per Leg)

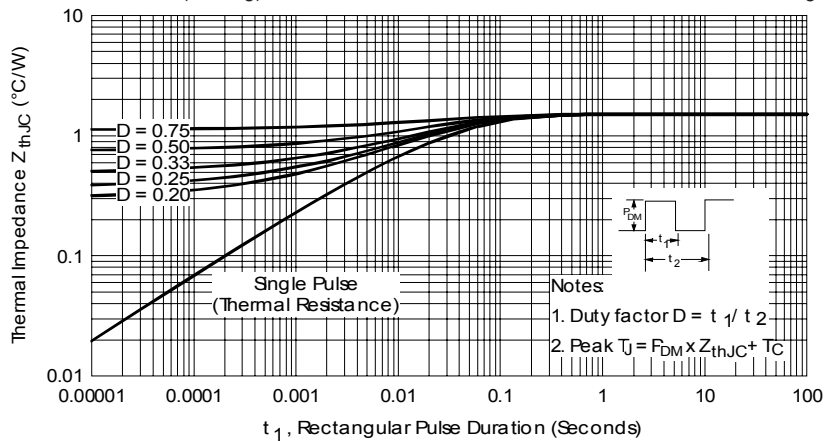

Fig. 4 - Max. Thermal Impedance Z_{thJC} Characteristics (Per Leg)

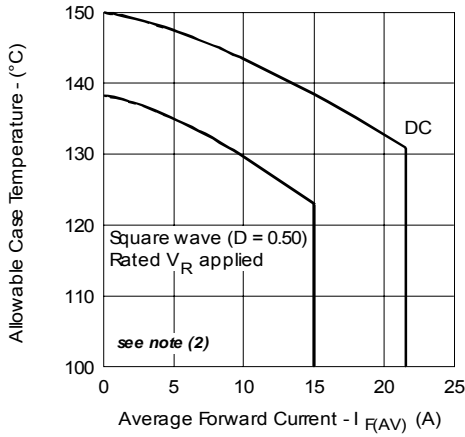

Fig. 5 - Max. Allowable Case Temperature Vs. Average Forward Current (Per Leg)

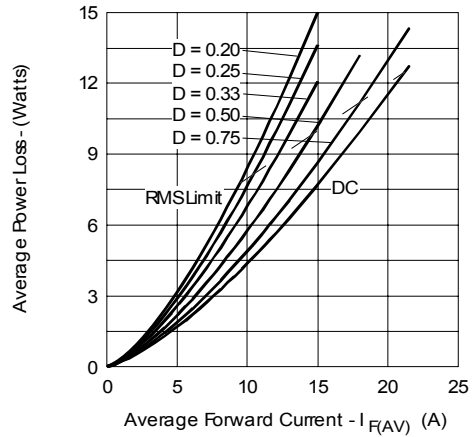

Fig. 6 - Forward Power Loss Characteristics (Per Leg)

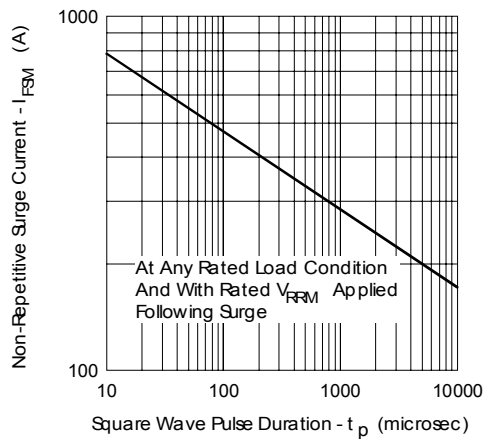

Fig. 7 - Max. Non-Repetitive Surge Current (Per Leg)

(2) Formula used: $T_c = T_j - (Pd + Pd_{REV}) \times R_{thJC}$

Pd = Forward Power Loss = $I_{F(AV)} \times V_{FM} @ (I_{F(AV)} / D)$ (see Fig. 6);

Pd_{REV} = Inverse Power Loss = $V_{R1} \times I_R (1 - D)$; $I_R @ V_{R1}$ = rated V_R

Outline Table

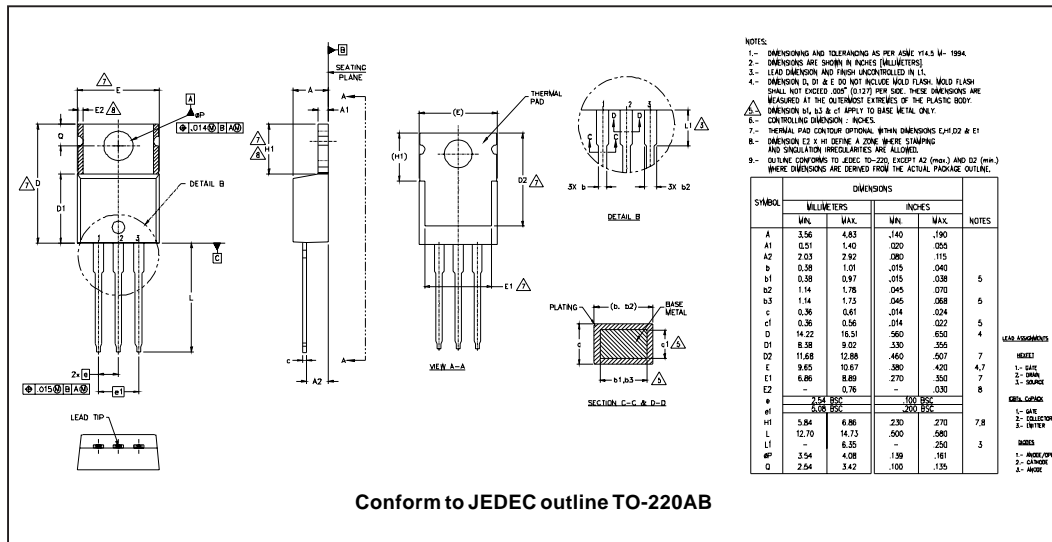

Part Marking Information

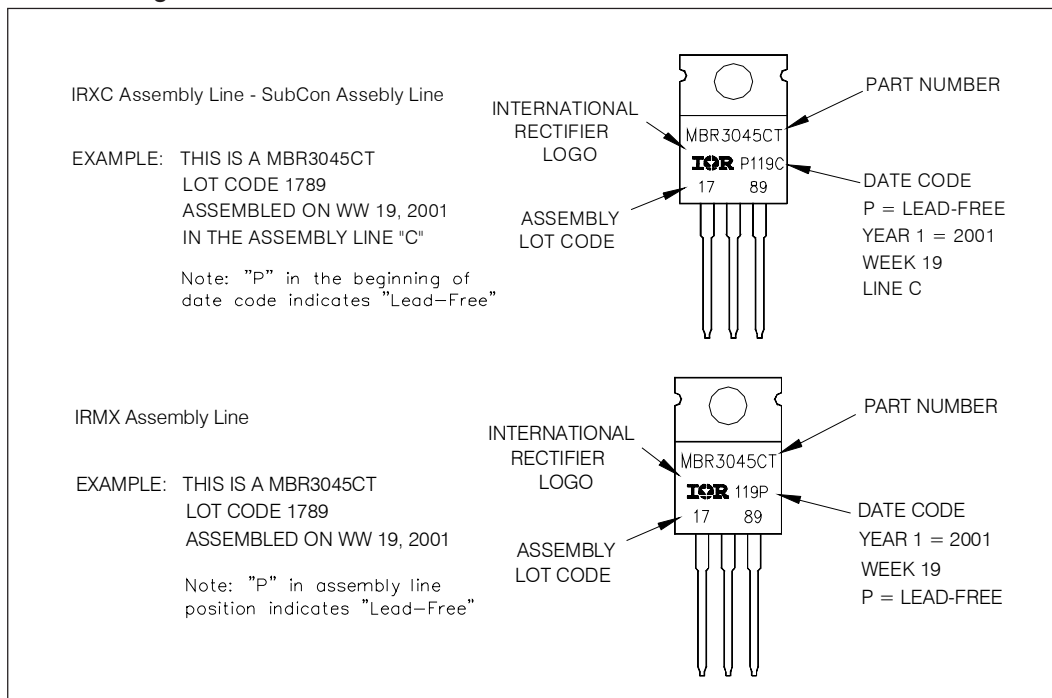

Ordering Information Table

Device Code				
MBR	30	45	CT	PbF
①	②	③	④	⑤
1	-	Schottky MBR Series		
2	-	Current Rating (30 = 30A)		
3	-	Voltage Ratings	35 = 35V	
4	-	CT = Essential Part Number	45 = 45V	
5	-	• none = Standard Production		
		• PbF = Lead-Free		

Data and specifications subject to change without notice.
This product has been designed and qualified for Industrial Level and Lead-Free.
Qualification Standards can be found on IR's Web site.