



MBRB15..CTPbF MBR15..CT-1PbF

SCHOTTKY RECTIFIER

15 Amp

$I_{F(AV)} = 15\text{Amp}$
 $V_R = 35/45\text{V}$

Major Ratings and Characteristics



Characteristics	Values	Units
$I_{F(AV)}$ Rectangular waveform	15	A
V_{RRM}	35/45	V
I_{FSM} @ tp = 5 μs sine	690	A
V_F @7.5Apk, $T_J=125^\circ\text{C}$	0.57	V
T_J	-65 to 150	$^\circ\text{C}$

Description/ Features

The MBR15.. center tap Schottky rectifier has been optimized for low reverse leakage at high temperature. The proprietary barrier technology allows for reliable operation up to 150° C junction temperature. Typical applications are in switching power supplies, converters, free-wheeling diodes, and reverse battery protection.

- 150° C T_J operation
- Center tap TO-220 package
- Low forward voltage drop
- High purity, high temperature epoxy encapsulation for enhanced mechanical strength and moisture resistance
- High frequency operation
- Guard ring for enhanced ruggedness and long term reliability
- Lead-Free ("PbF" suffix)

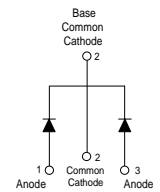
Case Styles

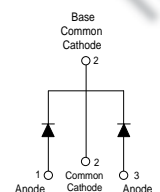
<p>MBRB15..CTPbF</p>   <p>D²PAK</p>	<p>MBR15..CT-1PbF</p>   <p>TO-262</p>
--	---

Voltage Ratings

Parameters	MBRB1535CT MBR1535CT-1	MBRB1545CT MBR1545CT-1
V _R Max. DC Reverse Voltage (V)	35	45
V _{RWM} Max. Working Peak Reverse Voltage (V)		

Absolute Maximum Ratings

Parameters	Value	Units	Conditions
I _{F(AV)} Max. Aver. Forward Current (Per Leg) (Per Device)	7.5 15	A	@ T _C = 131 °C (Rated V _R)
I _{FSM} Max. Peak One Cycle Non Repetitive Surge	690 150	A	5µs Sine or 3µs Rect. pulse Surge applied at rated load condition halfwave single phase 60Hz Following any rated load condition and with rated V _{RRM} applied
E _{AS} Non-Repetitive Avalanche Energy	7	mJ	(Per Leg) T _J = 25 °C, I _{AS} = 2 Amps, L = 3.5 mH
I _{AR} Repetitive Avalanche Current (Per Leg)	2	A	Current decaying linearly to zero in 1 µsec Frequency limited by T _J max. V _A = 1.5 x V _R typical

Electrical Specifications

Parameters	Value	Units	Conditions
V _{FM} Max. Forward Voltage Drop (1)	0.84 0.57 0.72	V	@ 15A T _J = 25 °C @ 7.5A T _J = 125 °C @ 15A
I _{RM} Max. Instantaneous Reverse Current (1)	0.1 15	mA	T _J = 25 °C T _J = 125 °C Rated DC voltage
C _T Max. Junction Capacitance	400	pF	V _R = 5V _{DC} (test signal range 100Khz to 1Mhz) 25°C
L _S Typical Series Inductance	8.0	nH	Measured from top of terminal to mounting plane
dv/dt Max. Voltage Rate of Change (Rated V _R)	10000	V/ µs	

(1) Pulse Width < 300µs, Duty Cycle <2%

Thermal-Mechanical Specifications

Parameters	Value	Units	Conditions
T _J Max. Junction Temperature Range	-65 to 150	°C	
T _{stg} Max. Storage Temperature Range	-65 to 175	°C	
R _{thJC} Max. Thermal Resistance Junction to Case (Per Leg)	3.0	°C/W	DC operation
R _{thCS} Typical Thermal Resistance, Case to Heatsink	0.50	°C/W	Mounting surface, smooth and greased
R _{thJA} Max. Thermal Resistance Junction	60	°C/W	DC operation
wt Approximate Weight	2 (0.07)	g (oz.)	
T Mounting Torque	Min. 6 (5) Max. 12 (10)	Kg-cm (lbf-in)	
Device Marking	MBRB15..CT MBR15..CT-1		Case style D ² Pak Case style TO-262

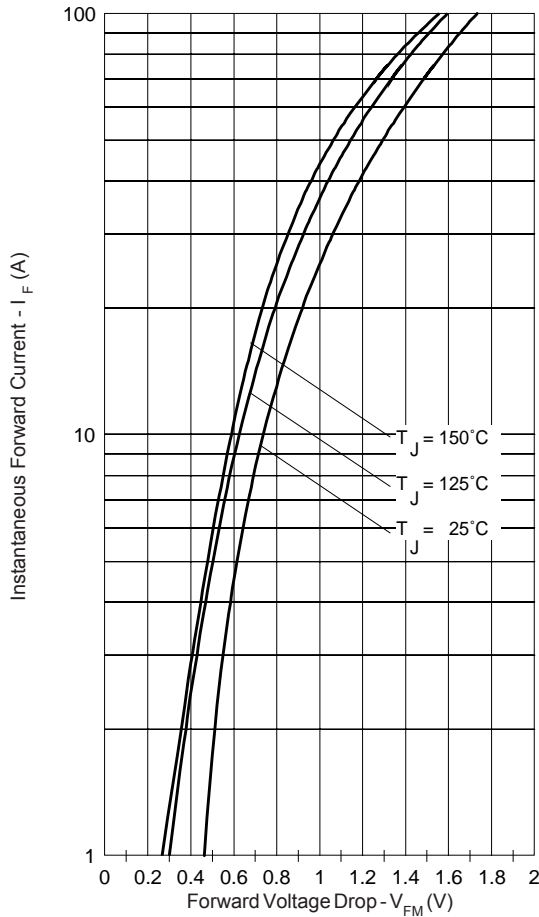

Fig. 1 - Max. Forward Voltage Drop Characteristics (Per Leg)

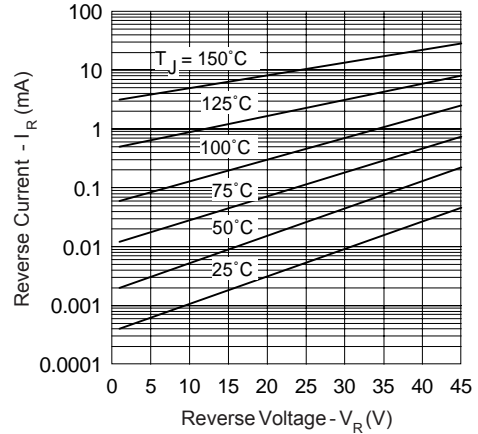

Fig. 2 - Typical Values Of Reverse Current Vs. Reverse Voltage (Per Leg)

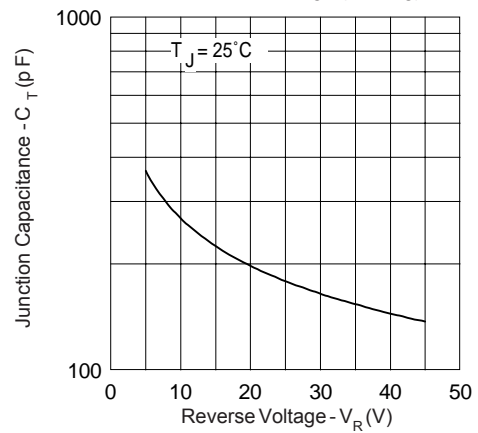

Fig. 3 - Typical Junction Capacitance Vs. Reverse Voltage (Per Leg)

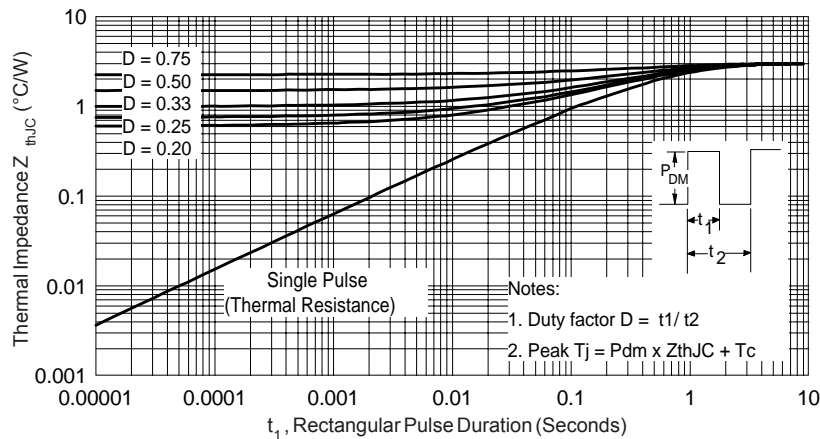

Fig. 4 - Max. Thermal Impedance Z_{thJC} Characteristics (Per Leg)

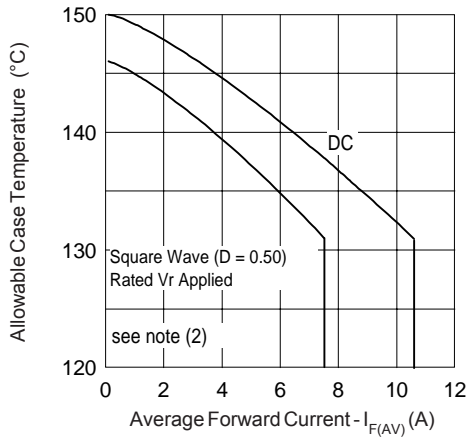

Fig. 5 - Max. Allowable Case Temperature Vs. Average Forward Current

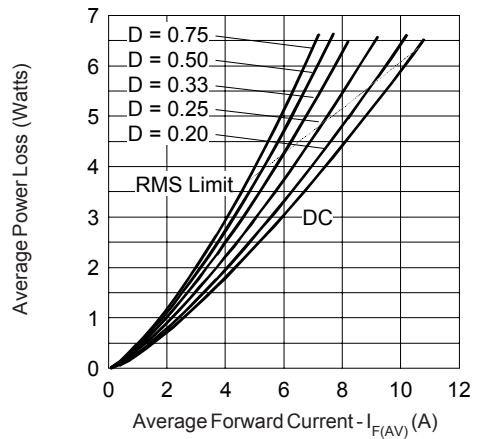

Fig. 6 - Forward Power Loss Characteristics

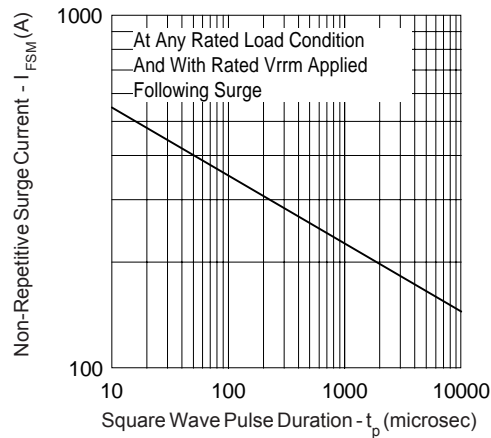
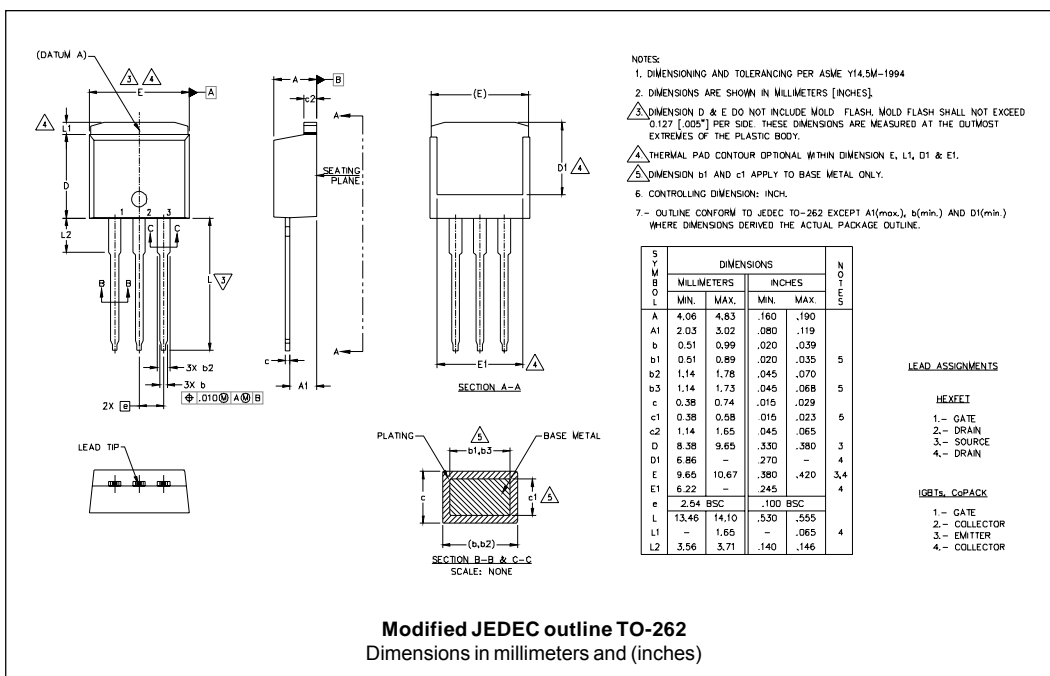
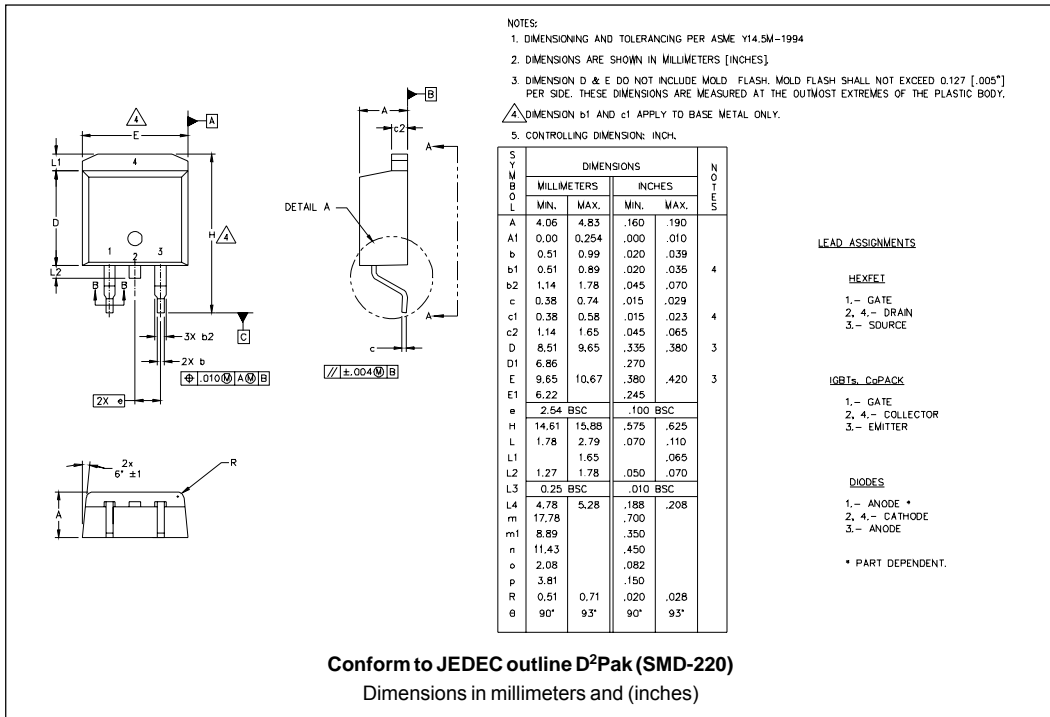

Fig. 7 - Max. Non-Repetitive Surge Current (Per Leg)

(2) Formula used: $T_C = T_J - (Pd + Pd_{REV}) \times R_{thJC}$;
 $Pd = \text{Forward Power Loss} = I_{F(AV)} \times V_{FM} @ (I_{F(AV)} / D)$ (see Fig. 6);
 $Pd_{REV} = \text{Inverse Power Loss} = V_{R1} \times I_R (1 - D)$; $I_R @ V_{R1} = \text{rated } V_R$

Outlines Table



Part Marking Information

D²PAK

EXAMPLE: THIS IS A MBRB1545CT
LOT CODE 8024
ASSEMBLED ON WW 02, 2000

Note: "P" in assembly line position indicates "Lead-Free"

INTERNATIONAL RECTIFIER LOGO

ASSEMBLY LOT CODE

PART NUMBER

DATE CODE
YEAR 0 = 2000
WEEK 02
P = LEAD-FREE

TO-262

EXAMPLE: THIS IS A MBR1545CT-1
LOT CODE 1789
ASSEMBLED ON WW 19, 2002

Note: "P" in assembly line position indicates "Lead-Free"

INTERNATIONAL RECTIFIER LOGO

ASSEMBLY LOT CODE

PART NUMBER

DATE CODE
YEAR 2 = 2002
WEEK 19
P = LEAD-FREE

Tape & Reel Information

SECTION Y-Y

Ao	10.50	+/- 0.1
B0	15.80	+/- 0.1
B2	10.25	+/- 0.1
Ko	4.90	+/- 0.1
F	11.50	+/- 0.1
P1	16.00	+/- 0.1
W	24.00	+/- 0.3

NOTES:

- 1.0 10 SPROCKET HOLE PITH CUMULATIVE TOLERANCE ±.02
- 2.0 CAMBER NOT TO EXCEED 1mm in 100mm
- 3.0 MATERIAL: CONDUCTIVE BLACK STYRENIC ALLOY
- 4.0 Ko MEASURED FROM A PLANE ON THE INSIDE BOTTOM OF THE POCKET TO THE TOP SURFACE OF THE CARRIER
- 5.0 MEASURED FROM CENTRELINE OF SPROCKET HOLE TO CENTRELINE OF POCKET
- 6.0 VENDOR: (OPTIONAL)
- 7.0 MUST ALSO MEET REQUIREMENTS OF EIA STANDAR #EIA-481A TAPING OF SURFACE MOUNT COMPONENTS FOR AUTOMATIC PLACEMENT
- 8.0 SURFACE RESISTIVITY OF MOLDED MATL. MUST MEASURE LESS OR EQUAL TO 10⁶ OHMS PER SQUARE. MEASURED IN ACCORDANCE TO PROCEDURE GIVEN IN ASTM D-257 & ASTM D-991
- 9.0 TOTAL LENGTH PER REEL MUST BE 45 METERS
- 10.0 © CRITICAL

Dimensions in millimeters and (inches)

Ordering Information Table

Device Code	MBR	B	15	45	CT	-1	TRL	PbF
	①	②	③	④	⑤	⑥	⑦	⑧
1	-	Essential Part Number						
2	-	B = Surface Mount None = TO-220						
3	-	Current Rating (15 = 15A)						
4	-	Voltage code: Code = V_{RRM}						
5	-	CT = Essential Part Number						
6	-	"-1" = TO-262						
7	-	<ul style="list-style-type: none"> • none = Tube (50 pieces) • TRL = Tape & Reel (Left Oriented - for D²Pak only) • TRR = Tape & Reel (Right Oriented - for D²Pak only) 						
8	-	<ul style="list-style-type: none"> • none = Standard Production • PbF = Lead-Free 						

35	=	35V
40	=	40V
45	=	45V

```

MBR1545CT
*****
*       This model has been developed by       *
*       Wizard SPICE MODEL GENERATOR (1999)   *
*       (International Rectifier Corporation)   *
*       contains Proprietary Information      *
*****
* SPICE Model Diode is composed by a         *
* simple diode plus paralalled VCG2T        *
*****
.SUBCKT MBR1545 ANO CAT
D1 ANO 1 DMOD (0.03191)
*Define diode model
.MODEL DMOD D (IS=9.72464638473799E-05A,N=1.30648926537753,BV=52V,
+ IBV=0.195508065728349A,RS= 0.000727548,CJO=1.94829876431799E-08,
+ VJ=2.27282978121533,XTI=2, EG=0.854458710837653)
*****
*Implementation of VCG2T
VX 1 2 DC 0V
R1 2 CAT TRES 1E-6
.MODEL TRES RES (R=1,TC1=27.6281424524011)
GP1 ANO CAT VALUE={-ABS(I(VX))*(EXP((((-5.219758E-03/27.62814)*(V(2,CAT)*1E6)/
(I(VX)+1E-6)-1))+1)*7.000165E-02*ABS(V(ANO,CAT)))-1}
*****
.ENDS MBR1545

Thermal Model Subcircuit
.SUBCKT MBR1545 5 1

CTHERM1      5      4      1.05E+00
CTHERM2      4      3      4.44E+00
CTHERM3      3      2      1.16E+01
CTHERM4      2      1      6.12E+01

RTHERM1      5      4      1.33E+00
RTHERM2      4      3      1.19E+00
RTHERM1      3      2      3.81E-01
RTHERM1      2      1      9.54E-02

.ENDS MBR1545
    
```

Data and specifications subject to change without notice.
 This product has been designed and qualified for Industrial Level and Lead-Free.
 Qualification Standards can be found on IR's Web site.



IR WORLD HEADQUARTERS: 233 Kansas St., El Segundo, California 90245, USA Tel: (310) 252-7105
 TAC Fax: (310) 252-7309
 Visit us at www.irf.com for sales contact information. 07/06