



MBRD320
MBRD330
MBRD340

SCHOTTKY RECTIFIER

3.0 Amp

$$I_{F(AV)} = 3.0\text{Amp}$$

$$V_R = 20/40\text{V}$$

Major Ratings and Characteristics

Characteristics	Values	Units
$I_{F(AV)}$ Rectangular waveform	3.0	A
V_{RRM}	20/40	V
I_{FSM} @tp = 5 μ s sine	490	A
V_F @3 Apk, $T_J = 125^\circ\text{C}$	0.49	V
T_J	-40 to 150	$^\circ\text{C}$

Description/ Features

The MBRD320, MBRD330, MBRD340 surface mount Schottky rectifier has been designed for applications requiring low forward drop and small foot prints on PC board. Typical applications are in disk drives, switching power supplies, converters, free-wheeling diodes, battery charging, and reverse battery protection.

- Popular D-PAK outline
- Small foot print, surface mountable
- Low forward voltage drop
- High frequency operation
- Guard ring for enhanced ruggedness and long term reliability

Case Styles



D-PAK (TO-252AA)

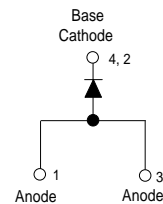

Voltage Ratings

Part number	MBRD320	MBRD330	MBRD340
V _R Max. DC Reverse Voltage (V)	20	30	40
V _{RWM} Max. Working Peak Reverse Voltage (V)			

Absolute Maximum Ratings

Parameters	Value	Units	Conditions
I _{F(AV)} Max. Average Forward Current	3.0	A	50% duty cycle @ T _L = 133°C, rectangular wave form
I _{FSM} Max. Peak One Cycle Non-Repetitive Surge Current	490		5µs Sine or 3µs Rect. pulse
	75		10ms Sine or 6ms Rect. pulse
E _{AS} Non Repetitive Avalanche Energy	8.0	mJ	T _J = 25 °C, I _{AS} = 1Amp, L = 16mH
I _{AR} Repetitive Avalanche Current	1.0	A	Current decaying linearly to zero in 1 µsec Frequency limited by T _J max. Va = 1.5 x Vr typical

Electrical Specifications

Parameters	Typ.	Max.	Units	Conditions
V _{FM} Max. Forward Voltage Drop (1) See Fig. 1	0.48	0.6	V	@ 3A
	0.58	0.7	V	@ 6A
	0.41	0.49	V	@ 3A
	0.55	0.625	V	@ 6A
I _{RM} Max. Reverse Leakage Current (1) See Fig. 2	0.02	0.2	mA	T _J = 25 °C
	10.7	20	mA	T _J = 125 °C
C _T Typical Junction Capacitance	189	-	pF	V _R = 5V _{DC} (test signal range 100kHz to 1Mhz), @ 25°C
L _S Typical Series Inductance	5.0	-	nH	Measured lead to lead 5mm from package body
dv/dt Max. Voltage Rate of Change	-	10000	V/ µs	(Rated V _R)

(1) Pulse Width < 300µs, Duty Cycle <2%

Thermal-Mechanical Specifications

Parameters	Value	Units	Conditions
T _J Max. Junction Temperature Range(*)	-40 to 150	°C	
T _{stg} Max. Storage Temperature Range	-40 to 175	°C	
R _{thJC} Max. Thermal Resistance Junction to Case	6.0	°C/W	DC operation * See Fig. 4
R _{thJA} Max. Thermal Resistance Junction to Ambient	80	°C/W	
wt Approximate Weight	0.3 (0.01)	g (oz.)	
Case Style	D-PAK		Similar to TO-252AA
Device Marking	MBRD340		

(*) $\frac{dP_{tot}}{dT_j} < \frac{1}{R_{th(j-a)}}$ thermal runaway condition for a diode on its own heatsink

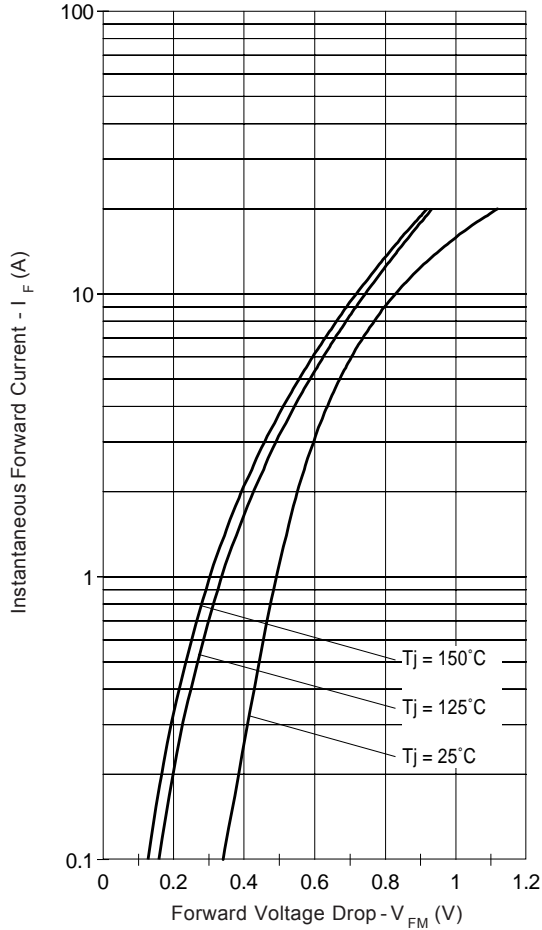

Fig. 1 - Maximum Forward Voltage Drop Characteristics

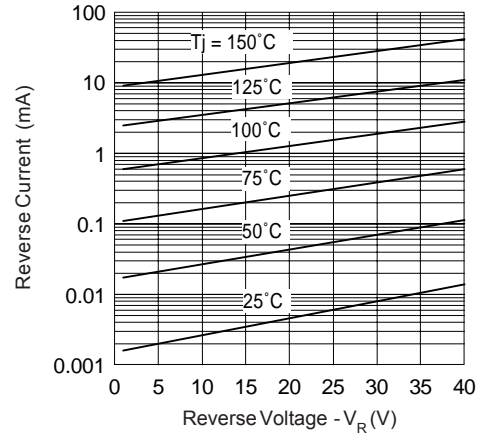

Fig. 2 - Typical Values of Reverse Current Vs. Reverse Voltage

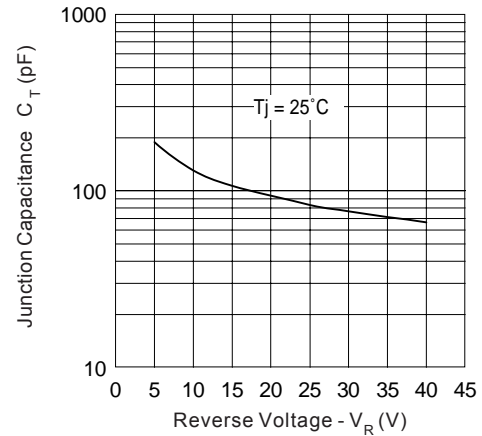

Fig. 3 - Typical Junction Capacitance Vs. Reverse Voltage

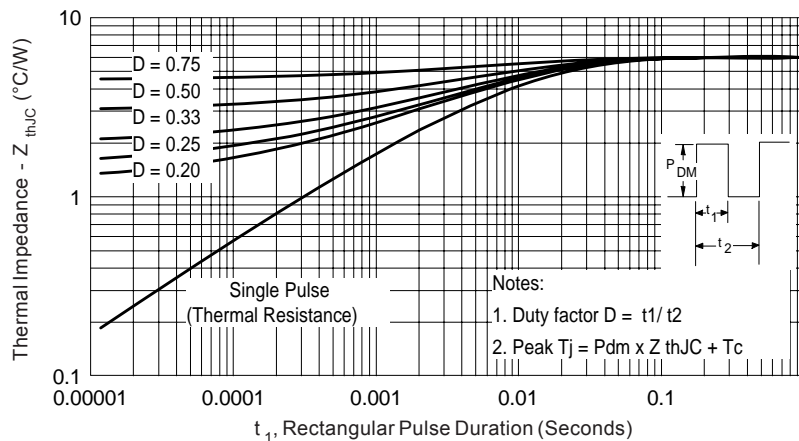

Fig. 4 - Maximum Thermal Impedance Z_{thJC} Characteristics

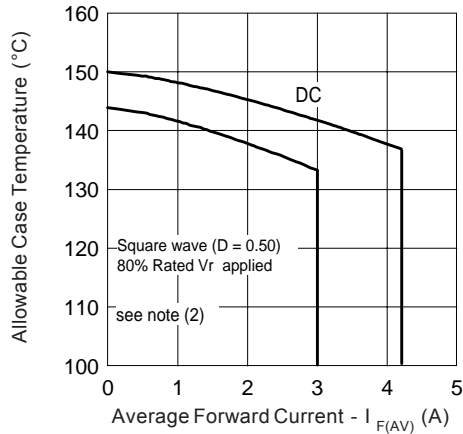

Fig. 5 - Maximum Allowable Case Temperature Vs. Average Forward Current

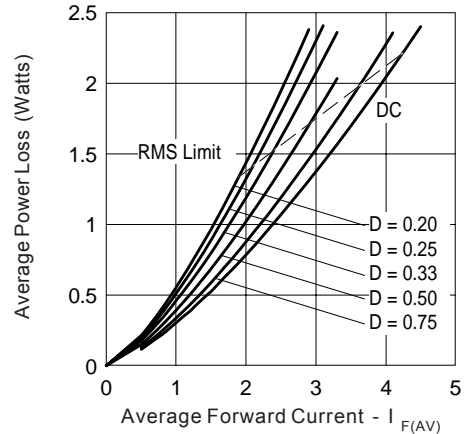

Fig. 6 - Forward Power Loss Characteristics

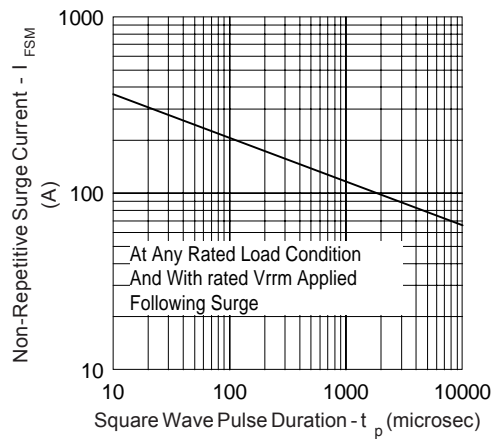
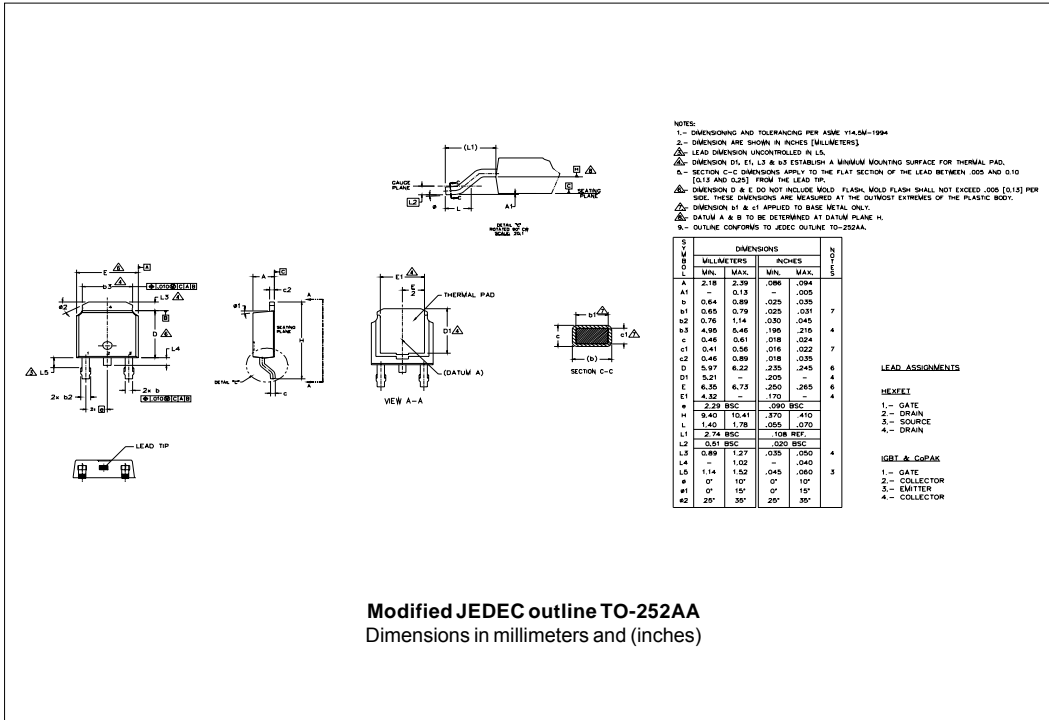

Fig. 7 - Maximum Non-Repetitive Surge Current

- (2) Formula used: $T_C = T_J - (P_d + P_{d_{REV}}) \times R_{thJC}$;
 $P_d = \text{Forward Power Loss} = I_{F(AV)} \times V_{FM} @ (I_{F(AV)} / D)$ (see Fig. 6);
 $P_{d_{REV}} = \text{Inverse Power Loss} = V_{R1} \times I_R (1 - D); I_R @ V_{R1} = 80\% \text{ rated } V_R$

Outline Table



Part Marking Information

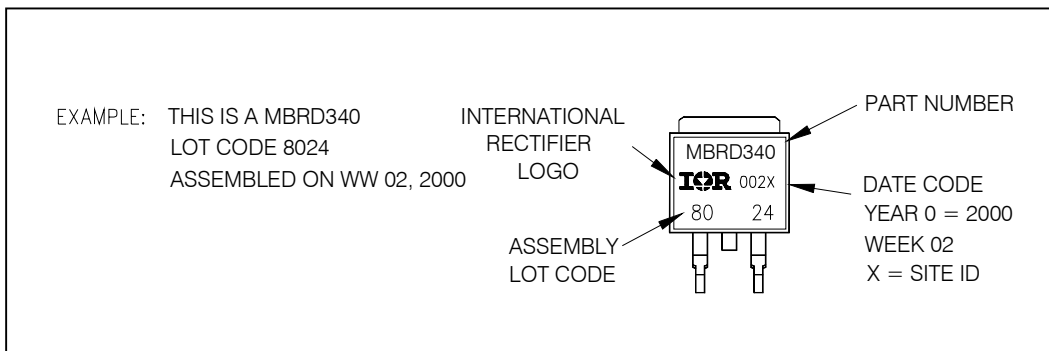

Tape & Reel Information

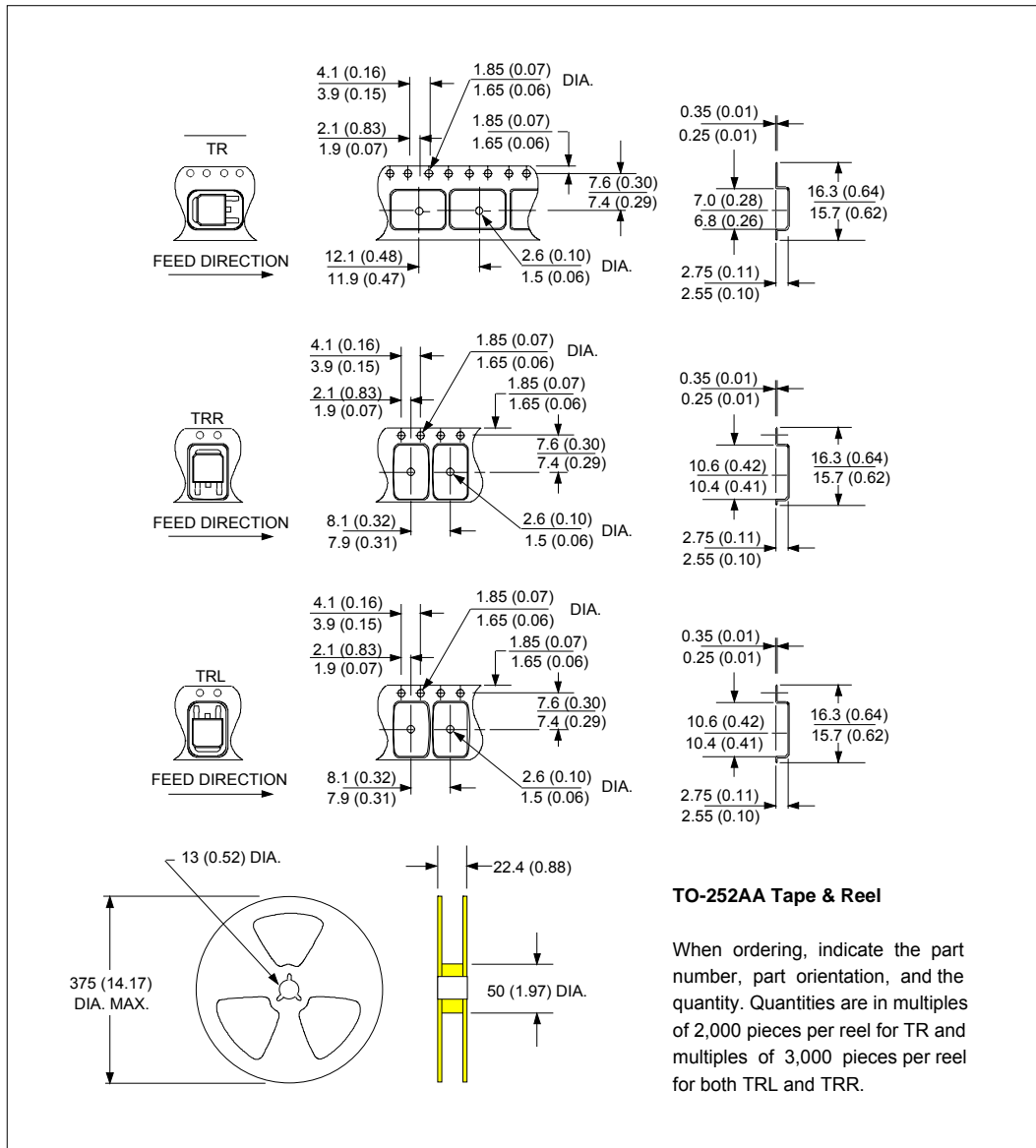

Ordering Information Table

Device Code	
MBR	D
3	40
TR	-
①	②
③	④
⑤	⑥

<p>1 - Schottky MBR Series</p> <p>2 - D = D-Pak (TO-252AA)</p> <p>3 - Current Rating (3 = 3A)</p> <p>4 - Voltage Ratings</p> <p>5 -</p> <ul style="list-style-type: none"> • none = Tube (50 pieces) • TR = Tape & Reel • TRL = Tape & Reel (Left Oriented) • TRR = Tape & Reel (Right Oriented) <p>6 -</p> <ul style="list-style-type: none"> • none = Standard Production • PbF = Lead-Free 	<table border="1" style="border-collapse: collapse;"> <tr> <td style="padding: 2px;">20 = 20V</td> </tr> <tr> <td style="padding: 2px;">30 = 30V</td> </tr> <tr> <td style="padding: 2px;">40 = 40V</td> </tr> </table>	20 = 20V	30 = 30V	40 = 40V
20 = 20V				
30 = 30V				
40 = 40V				

Data and specifications subject to change without notice.
 This product has been designed and qualified for AEC Q101 Level.
 Qualification Standards can be found on IR's Web site.