

Thyristor Modules

Thyristor/Diode Modules

$I_{TRMS} = 2 \times 450 \text{ A}$
 $I_{TAVM} = 2 \times 250 \text{ A}$
 $V_{RRM} = 1200-1800 \text{ V}$

V_{RSM} V_{DSM} V	V_{RRM} V_{DRM} V	Type	
1300	1200	MCC 255-12io1	MCD 255-12io1
1500	1400	MCC 255-14io1	MCD 255-14io1
1700	1600	MCC 255-16io1	MCD 255-16io1
1900	1800	MCC 255-18io1	MCD 255-18io1

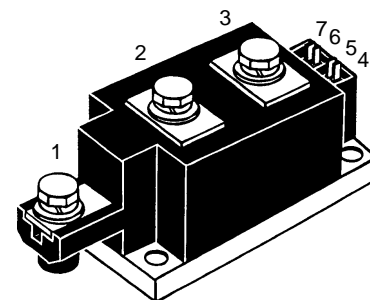

Symbol	Test Conditions	Maximum Ratings		
I_{TRMS}, I_{FRMS} I_{TAVM}, I_{FAVM}	$T_{VJ} = T_{VJM}$ $T_C = 85^\circ\text{C}; 180^\circ \text{ sine}$	450	A	
I_{TSM}, I_{FSM}	$T_{VJ} = 45^\circ\text{C};$ $V_R = 0$	$t = 10 \text{ ms (50 Hz)}$ $t = 8.3 \text{ ms (60 Hz)}$	A A	
	$T_{VJ} = T_{VJM}$ $V_R = 0$	$t = 10 \text{ ms (50 Hz)}$ $t = 8.3 \text{ ms (60 Hz)}$	A A	
$\int i^2 dt$	$T_{VJ} = 45^\circ\text{C}$ $V_R = 0$	$t = 10 \text{ ms (50 Hz)}$ $t = 8.3 \text{ ms (60 Hz)}$	A ² s A ² s	
	$T_{VJ} = T_{VJM}$ $V_R = 0$	$t = 10 \text{ ms (50 Hz)}$ $t = 8.3 \text{ ms (60 Hz)}$	A ² s A ² s	
$(di/dt)_{cr}$	$T_{VJ} = T_{VJM}$ $f = 50 \text{ Hz}, t_p = 200 \mu\text{s}$ $V_D = 2/3 V_{DRM}$ $I_G = 1 \text{ A},$ $di_G/dt = 1 \text{ A}/\mu\text{s}$	repetitive, $I_T = 860 \text{ A}$ non repetitive, $I_T = I_{TAVM}$	100 500	A/ μs A/ μs
$(dv/dt)_{cr}$	$T_{VJ} = T_{VJM}; V_{DR} = 2/3 V_{DRM}$ $R_{GK} = \infty; \text{method 1 (linear voltage rise)}$		1000	V/ μs
P_{GM}	$T_{VJ} = T_{VJM}$ $I_T = I_{TAVM}$	$t_p = 30 \mu\text{s}$ $t_p = 500 \mu\text{s}$	120 60	W W
P_{GAV} V_{RGM}			20 10	W V
T_{VJ} T_{VJM} T_{stg}			-40...+130 130 -40...+125	$^\circ\text{C}$ $^\circ\text{C}$ $^\circ\text{C}$
V_{ISOL}	50/60 Hz, RMS $I_{ISOL} \leq 1 \text{ mA}$	$t = 1 \text{ min}$ $t = 1 \text{ s}$	3000 3600	V~ V~
M_d	Mounting torque (M6) Terminal connection torque (M8)		4.5-7/40-62 11-13/97-115	Nm/lb.in. Nm/lb.in.
Weight	Typical including screws		750	g

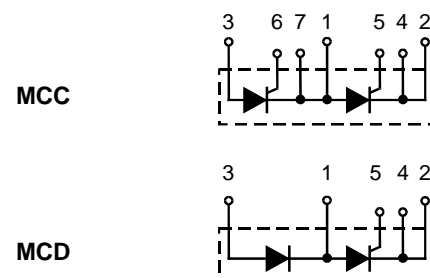

Features

- International standard package
- Direct copper bonded Al_2O_3 -ceramic with copper base plate
- Planar passivated chips
- Isolation voltage 3600 V~
- UL registered E 72873
- Keyed gate/cathode twin pins

Applications

- Motor control, softstarter
- Power converter
- Heat and temperature control for industrial furnaces and chemical processes
- Lighting control
- Solid state switches

Advantages

- Simple mounting
- Improved temperature and power cycling
- Reduced protection circuits

Data according to IEC 60747 and refer to a single thyristor/diode unless otherwise stated. IXYS reserves the right to change limits, test conditions and dimensions

Symbol	Test Conditions	Characteristic Values
I_{RRM}, I_{DRM}	$T_{VJ} = T_{VJM}; V_R = V_{RRM}; V_D = V_{DRM}$	40 mA
V_T, V_F	$I_T, I_F = 600 \text{ A}; T_{VJ} = 25^\circ\text{C}$	1.36 V
V_{T0}	For power-loss calculations only ($T_{VJ} = 130^\circ\text{C}$)	0.8 V
r_T		0.68 mΩ
V_{GT}	$V_D = 6 \text{ V}; T_{VJ} = 25^\circ\text{C}$	2 V
	$T_{VJ} = -40^\circ\text{C}$	3 V
I_{GT}	$V_D = 6 \text{ V}; T_{VJ} = 25^\circ\text{C}$	150 mA
	$T_{VJ} = -40^\circ\text{C}$	220 mA
V_{GD}	$T_{VJ} = T_{VJM}; V_D = 2/3 V_{DRM}$	0.25 V
I_{GD}	$T_{VJ} = T_{VJM}; V_D = 2/3 V_{DRM}$	10 mA
I_L	$T_{VJ} = 25^\circ\text{C}; t_p = 30 \mu\text{s}; V_D = 6 \text{ V}$ $I_G = 0.45 \text{ A}; di_G/dt = 0.45 \text{ A}/\mu\text{s}$	200 mA
I_H	$T_{VJ} = 25^\circ\text{C}; V_D = 6 \text{ V}; R_{GK} = \infty$	150 mA
t_{gd}	$T_{VJ} = 25^\circ\text{C}; V_D = 1/2 V_{DRM}$ $I_G = 1 \text{ A}; di_G/dt = 1 \text{ A}/\mu\text{s}$	2 μs
t_q	$T_{VJ} = T_{VJM}; I_T = 300 \text{ A}, t_p = 200 \mu\text{s}; -di/dt = 10 \text{ A}/\mu\text{s}$ typ. $V_R = 100 \text{ V}; dv/dt = 50 \text{ V}/\mu\text{s}; V_D = 2/3 V_{DRM}$	200 μs
Q_S	$T_{VJ} = 125^\circ\text{C}; I_T, I_F = 300 \text{ A}; -di/dt = 50 \text{ A}/\mu\text{s}$	760 μC
I_{RM}		275 A
R_{thJC}	per thyristor (diode); DC current per module	0.140 K/W
R_{thJK}	per thyristor (diode); DC current per module	0.07 K/W 0.18 K/W 0.09 K/W
	other values see Fig. 8/9	
d_s	Creeping distance on surface	12.7 mm
d_a	Creepage distance in air	9.6 mm
a	Maximum allowable acceleration	50 m/s ²

Optional accessories for modules
 Keyed Gate/Cathode twin plugs with wire length = 350 mm, gate = yellow, cathode = red
 Type ZY 180 L (L = Left for pin pair 4/5) } UL 758, style 1385,
 Type ZY 180 R (R = Right for pin pair 6/7) } CSA class 5851, guide 460-1-1

Dimensions in mm (1 mm = 0.0394")

MCC 255

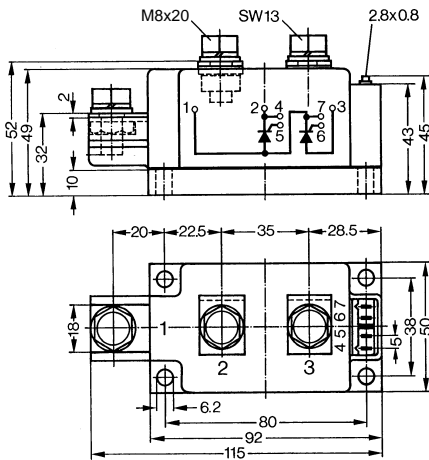

MCD 255

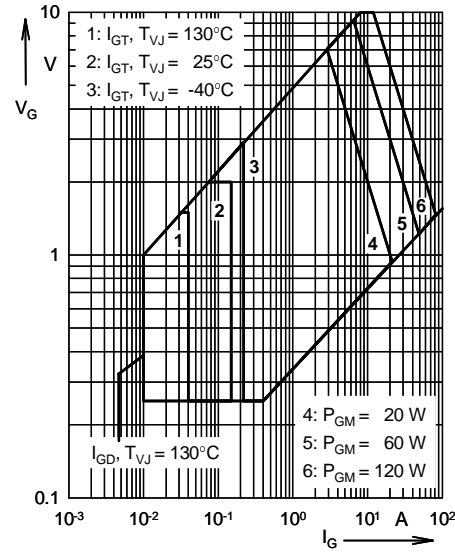
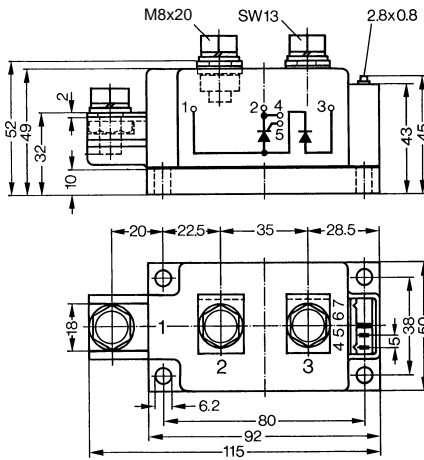

Fig. 1 Gate trigger characteristics

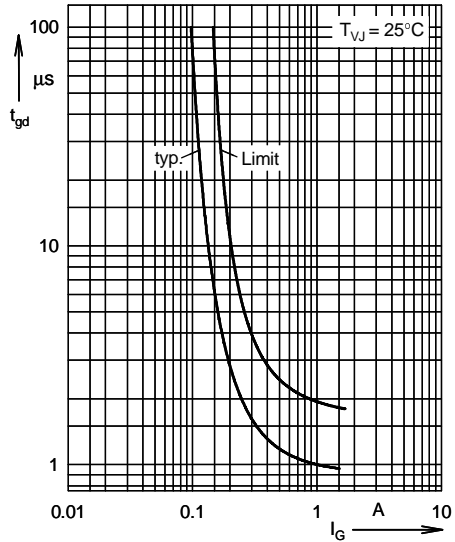

Fig. 2 Gate trigger delay time

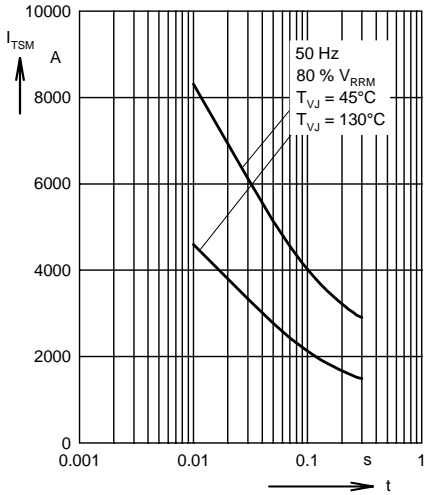

Fig. 3 Surge overload current
 I_{TSM}, I_{FSM} : Crest value, t: duration

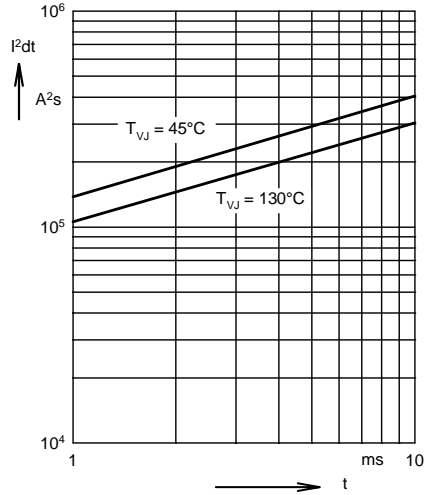

Fig. 4 $\int i^2 dt$ versus time (1-10 ms)

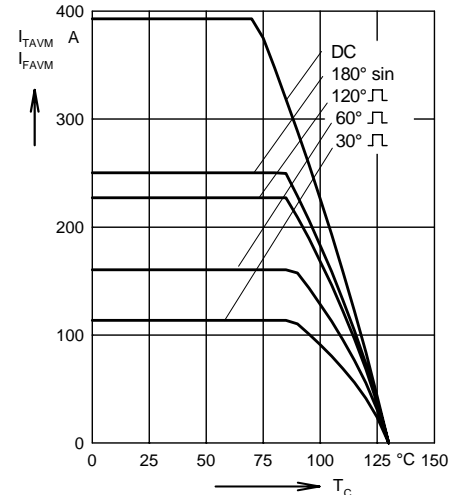

Fig. 4a Maximum forward current at case temperature

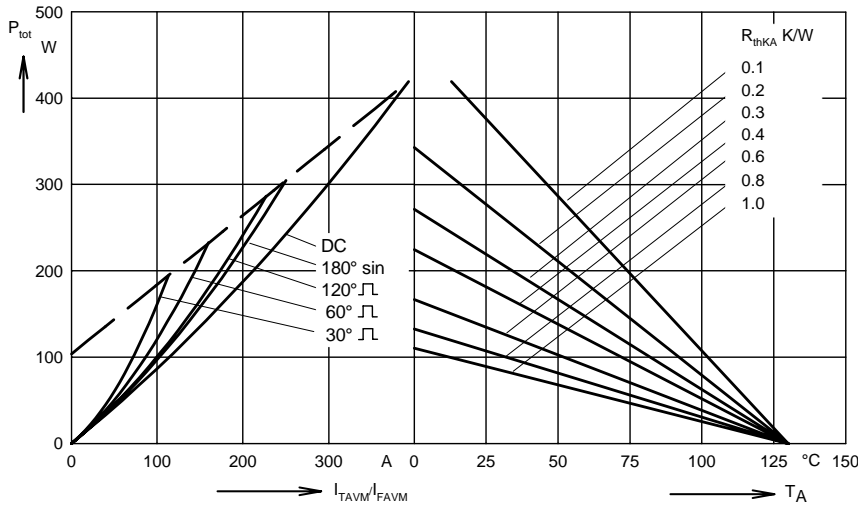

Fig. 5 Power dissipation versus on-state current and ambient temperature (per thyristor or diode)

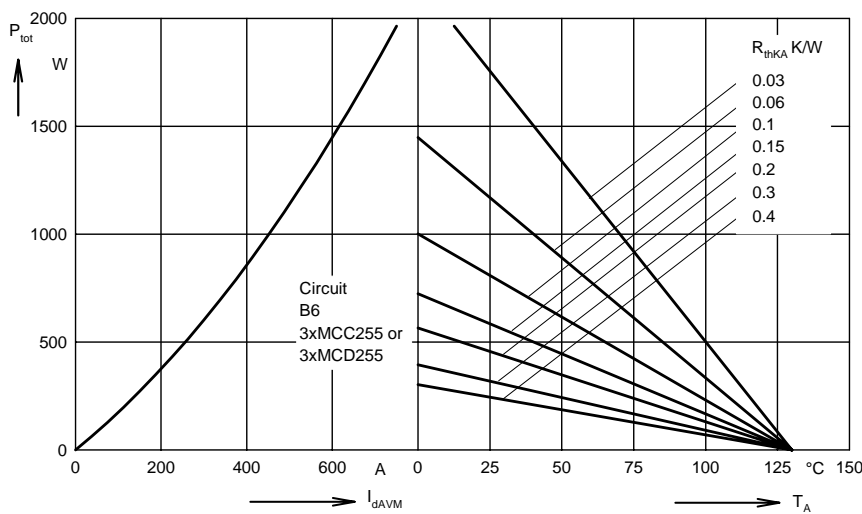

Fig. 6 Three phase rectifier bridge: Power dissipation versus direct output current and ambient temperature

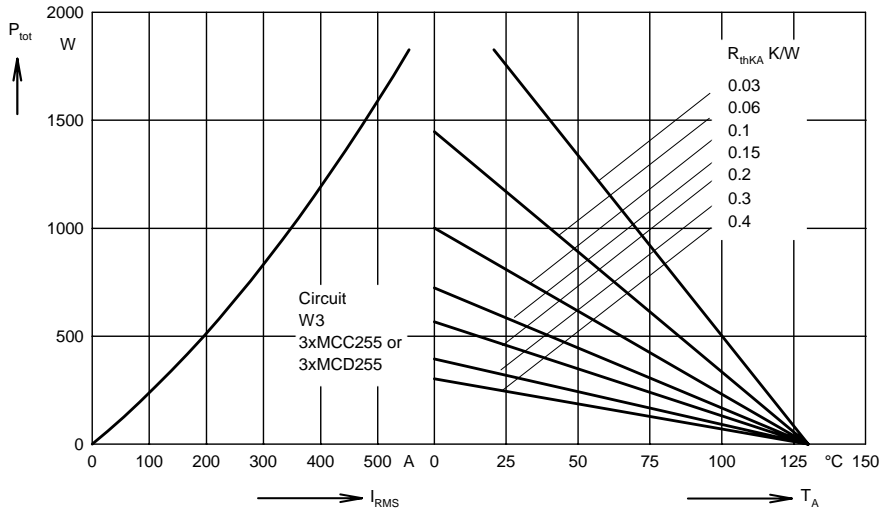

Fig. 7 Three phase AC-controller: Power dissipation versus RMS output current and ambient temperature

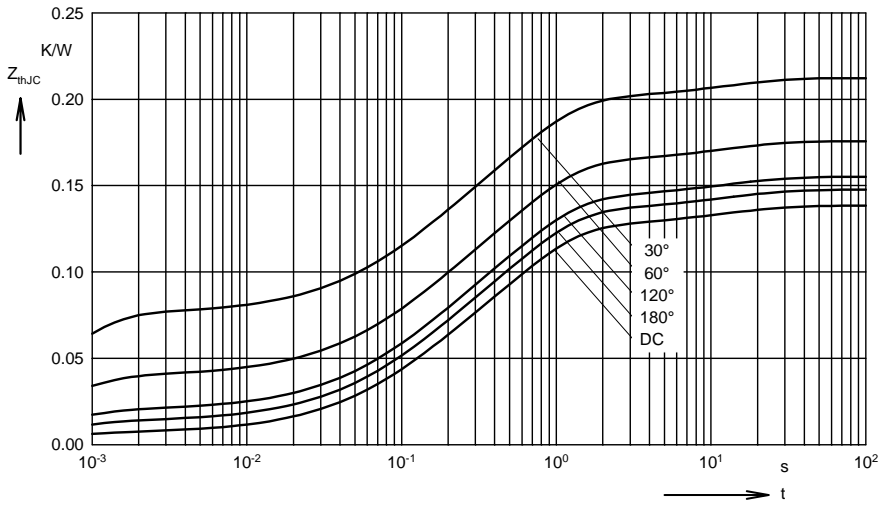

Fig. 8 Transient thermal impedance junction to case (per thyristor or diode)

R_{thJC} for various conduction angles d:

d	R_{thJC} (K/W)
DC	0.139
180°	0.148
120°	0.156
60°	0.176
30°	0.214

Constants for Z_{thJC} calculation:

i	R_{thi} (K/W)	t_i (s)
1	0.0066	0.00054
2	0.0358	0.098
3	0.0831	0.54
4	0.0129	12

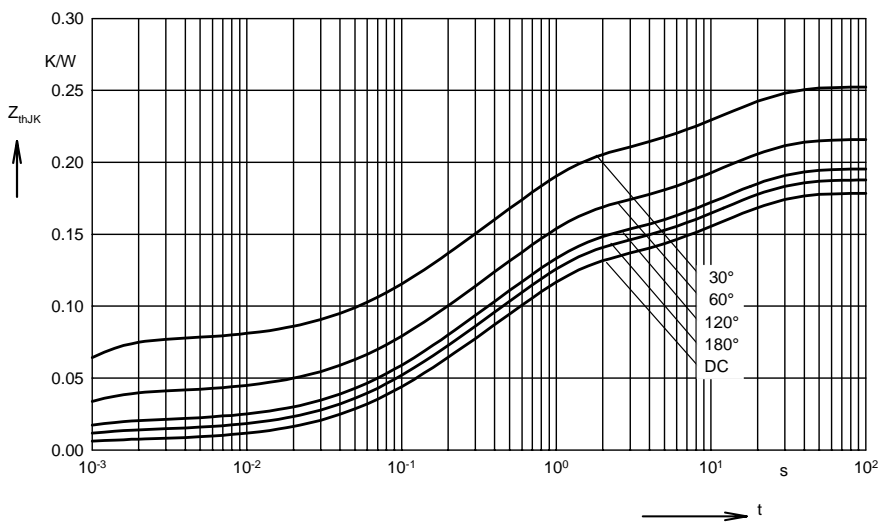

Fig. 9 Transient thermal impedance junction to heatsink (per thyristor or diode)

R_{thJK} for various conduction angles d:

d	R_{thJK} (K/W)
DC	0.179
180°	0.188
120°	0.196
60°	0.216
30°	0.254

Constants for Z_{thJK} calculation:

i	R_{thi} (K/W)	t_i (s)
1	0.0066	0.00054
2	0.0358	0.098
3	0.0831	0.54
4	0.0129	12
5	0.04	12

Copyright © Each Manufacturing Company.

All Datasheets cannot be modified without permission.

This datasheet has been download from :

www.AllDataSheet.com

100% Free DataSheet Search Site.

Free Download.

No Register.

Fast Search System.

www.AllDataSheet.com