

Resistors

Thick film rectangular resistors

MCR03 (1608 size)

●Features

- 1) Power rating of 1 / 10W
- 2) Highly reliable chip resistor
Ruthenium oxide dielectric offers superior resistance to the elements.
- 3) Electrodes not corroded by soldering
Thick film makes the electrodes very strong.
- 4) Resin protective coating for FX, D resistors
Absorbs impact, facilitates mounting.
- 5) ROHM resistors have approved ISO-9001 certification.
Design and specifications are subject to change without notice. Carefully check the specification sheet supplied with the product before using or ordering it.

●Ratings

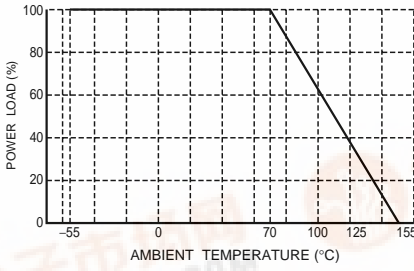
Item	Conditions	Specifications
Rated power	Power must be derated according to the power derating curve in Figure 1 when ambient temperature exceeds 70°C.  Fig.1	0.10W (1 / 10W) at 70°C
Rated voltage	The voltage rating is calculated by the following equation. If the value obtained exceeds the limiting element voltage, the voltage rating is equal to the maximum operating voltage. $E = \sqrt{P \times R}$ E: Rated voltage (V) P: Rated power (W) R: Nominal resistance (Ω)	Limiting element voltage 50V
Nominal resistance	See Table 1.	
Operating temperature		-55°C to +155°C

Resistors

Jumper type

Resistance	Max. 50mΩ
Rated current	1A
Operating temperature	-55°C to +155°C

Table 1

Resistance tolerance	Resistance range (Ω)	Resistance temperature coefficient (ppm/°C)
J (±5%)	1.0 ≤ R < 2.2 (E24)	500±350
	2.2 ≤ R < 10 (E24)	±500
	10 ≤ R ≤ 10M (E24)	±200
FX (±1%) (EZP type)	10 ≤ R ≤ 2.2M (E24,96)	±100
D (±0.5%) (EZP type)	10 ≤ R < 100 (E24)	±100
	100 ≤ R ≤ 1M (E24)	±50

- Before using components in circuits where they will be exposed to transients such as pulse loads (short-duration, high-level loads), be certain to evaluate the component in the mounted state. In addition, the reliability and performance of this component cannot be guaranteed if it is used with a steady state voltage that is greater than its rated voltage.

● Characteristics

Item	Guaranteed value		Test conditions (JIS C 5201-1)
	Resistor type	Jumper type	
Resistance	J : ±5% FX : ±1% D : ±0.5%	Max. 50mΩ	JIS C 5201-1 4.5
Variation of resistance with temperature	See Table.1		JIS C 5201-1 4.8 Measurement : -55 / +25 / +125°C
Overload	± (2.0%+0.1Ω)	Max. 50mΩ	JIS C 5201-1 4.13 Rated voltage (current) ×2.5, 2s. Limiting element voltage ×2 : 100V
Solderability	A new uniform coating of minimum of 95% of the surface being immersed and no soldering damage.		JIS C 5201-1 4.17 Rosin-Ethanol (25%WT) Soldering condition : 235±5°C Duration of immersion : 2.0±0.5s.
Resistance to soldering heat	± (1.0%+0.05Ω) No remarkable abnormality on the appearance.	Max. 50mΩ	JIS C 5201-1 4.18 Soldering condition : 260±5°C Duration of immersion : 10±1s.
Rapid change of temperature	± (1.0%+0.05Ω)	Max. 50mΩ	JIS C 5201-1 4.19 Test temp. : -55°C~+125°C 5cyc
Damp heat, steady state	± (3.0%+0.1Ω)	Max. 100mΩ	JIS C 5201-1 4.24 40°C, 93%RH Test time : 1,000h~1,048h
Endurance at 70°C	± (3.0%+0.1Ω)	Max. 100mΩ	JIS C 5201-1 4.25.1 Rated voltage (current), 70°C 1.5h : ON – 0.5h : OFF Test time : 1,000h~1,048h
Endurance	± (3.0%+0.1Ω)	Max. 100mΩ	JIS C 5201-1 4.25.3 155°C Test time : 1,000h~1,048h
Resistance to solvent	± (1.0%+0.05Ω)	Max. 50mΩ	JIS C 5201-1 4.29 23±5°C, Immersion cleaning, 5±0.5min. Solvent : 2-propanol
Bend strength of the end face plating	± (1.0%+0.05Ω) Without mechanical damage such as breaks.	Max. 50mΩ	JIS C 5201-1 4.33

Resistors

●External dimensions (Units : mm)

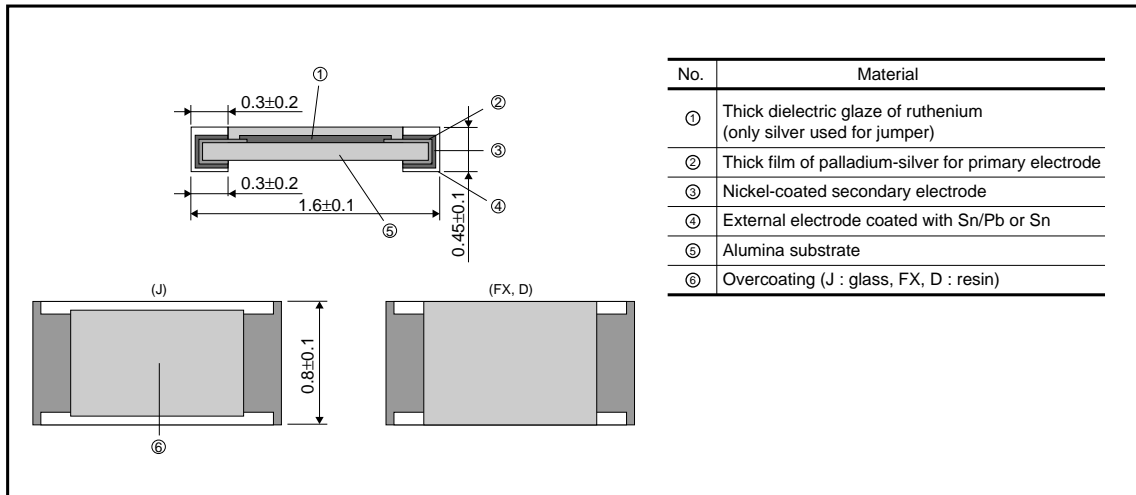

●Packaging

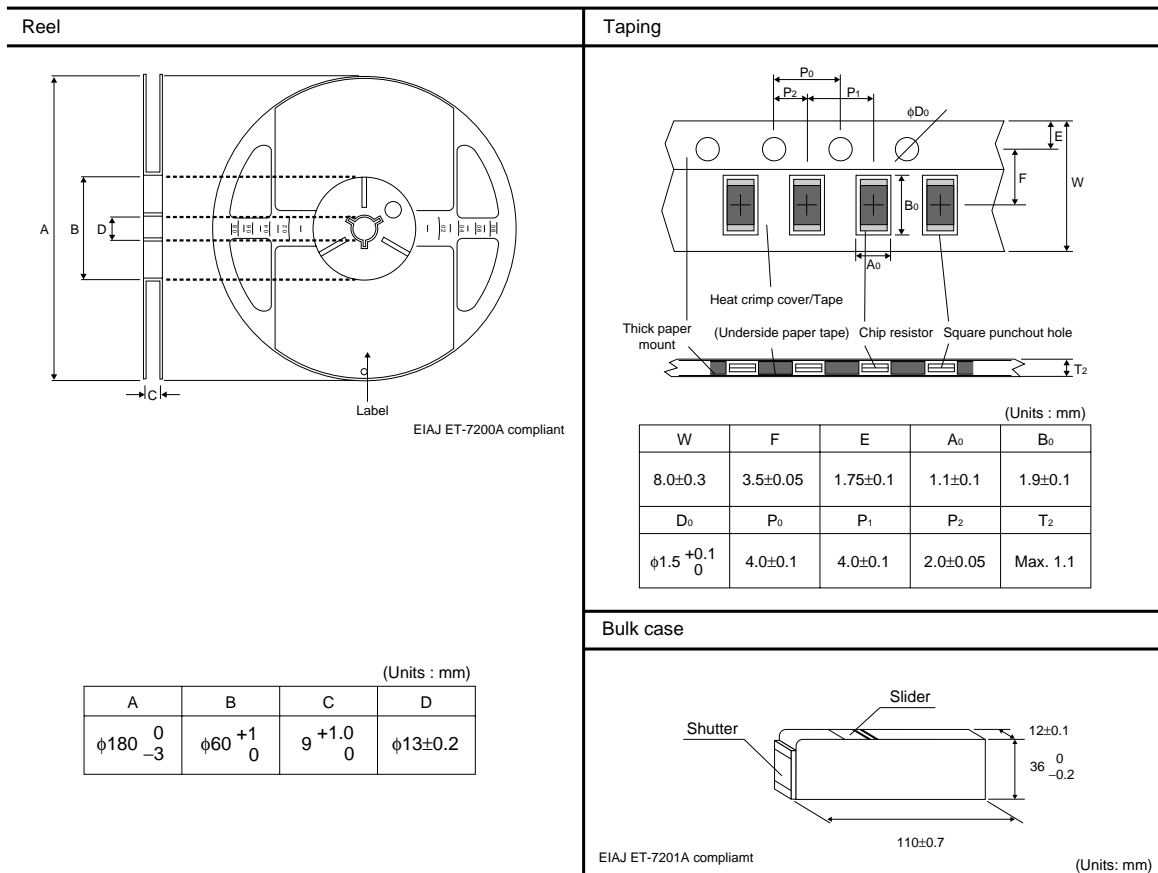

Resistors

●Part designation

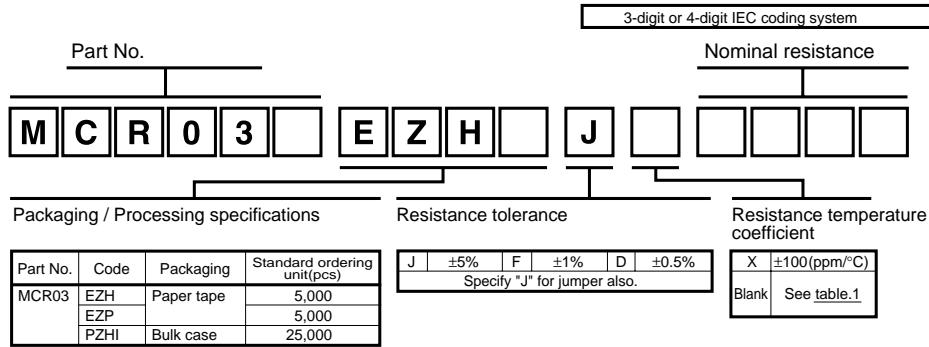

●Dimensions

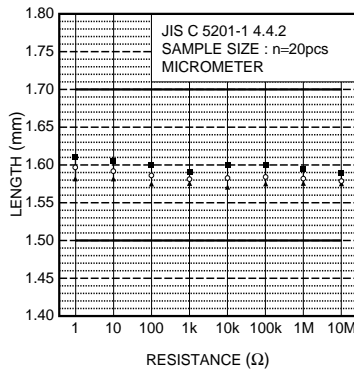

Fig.2 Dimensions (length)

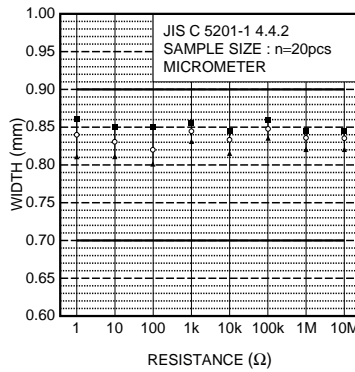

Fig.3 Dimensions (width)

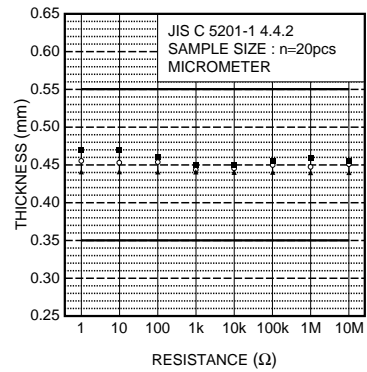

Fig.4 Dimensions (thickness)

●Electrical characteristics

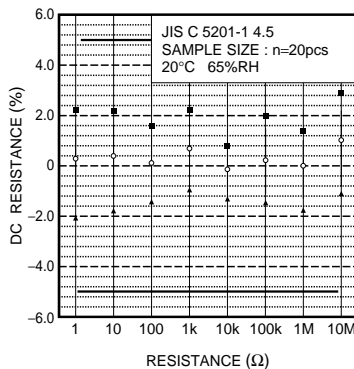

Fig.5 Resistance

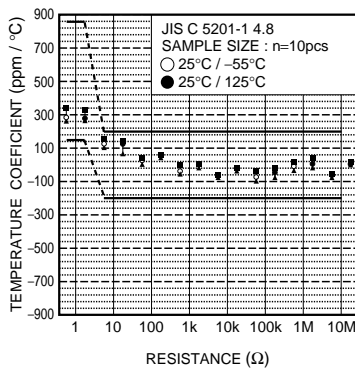

Fig.6 Variation of resistance with temperature

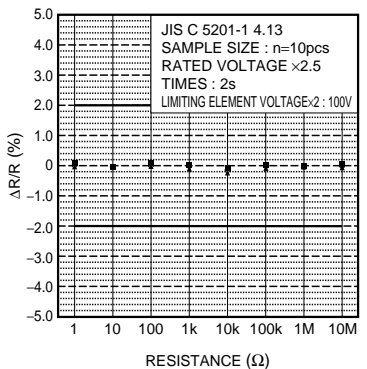

Fig.7 Overload

Resistors

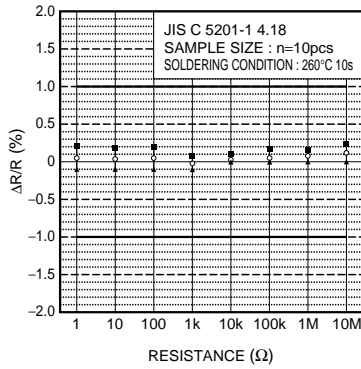

Fig.8 Resistance to soldering heat

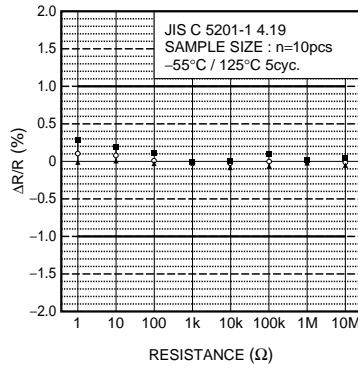

Fig.9 Rapid change of temperature

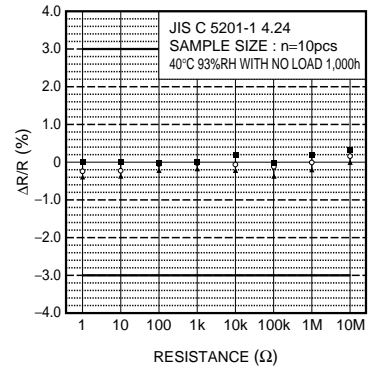

Fig.10 Damp heat, steady state

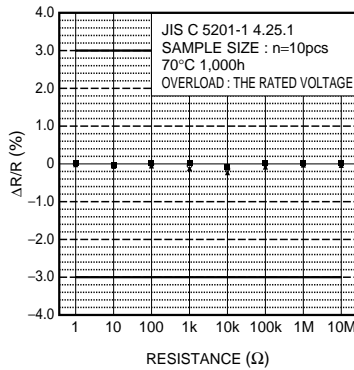

Fig.11 Endurance at 70°C

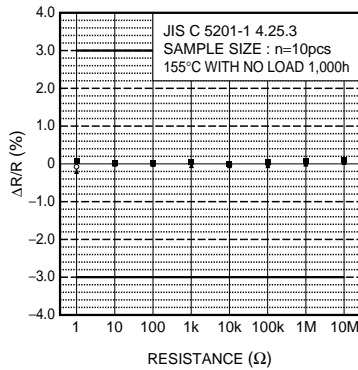

Fig.12 Endurance

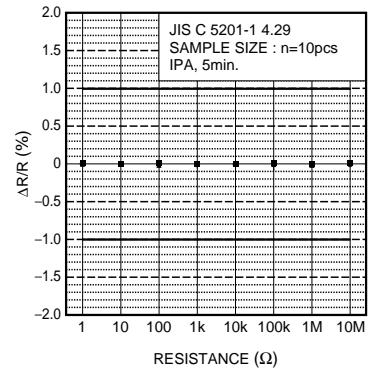

Fig.13 Resistance to solvents

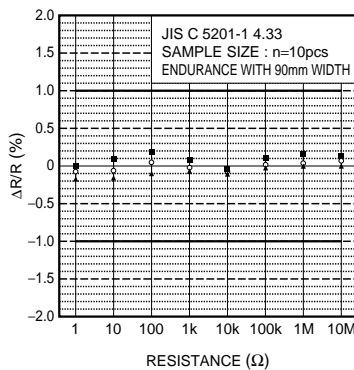

Fig.14 Bend strength of the end face plating