



**HIGH DENSITY  
PHOTOTRANSISTOR OPTICALLY  
COUPLED ISOLATORS**

**APPROVALS**

- UL recognised, File No. E91231
- 'X' SPECIFICATION APPROVALS
- **MCT6** -  
VDE 0884 in 3 available lead form : -  
- STD  
- G form  
- SMD approved to CECC 00802
- MCT61, MCT62, MCT66** -  
VDE 0884 approval pending
- EN60950 approval pending

**DESCRIPTION**

The MCT6, MCT61, MCT62 & MCT66 series of optically coupled isolators consist of infrared light emitting diodes and NPN silicon photo transistors in space efficient dual in line plastic packages mounted two channels per unit.

**FEATURES**

- Options :-  
10mm lead spread - add G after part no.  
Surface mount - add SM after part no.  
Tape&reel - add SMT&R after part no.
- High Isolation Voltage (5.3kV<sub>RMS</sub>, 7.5kV<sub>PK</sub>)

**APPLICATIONS**

- Computer terminals
- Industrial systems controllers
- Measuring instruments
- Signal transmission between systems of different potentials and impedances

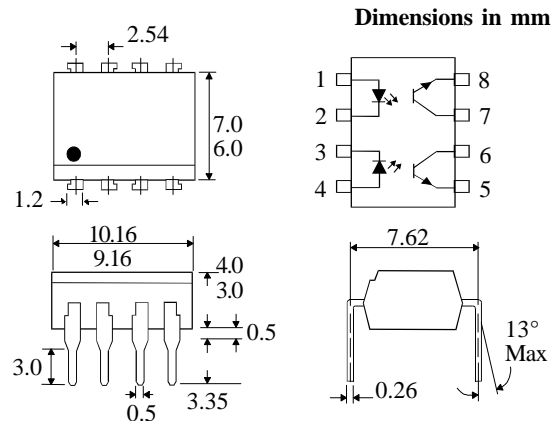

**ABSOLUTE MAXIMUM RATINGS  
(25°C unless otherwise specified)**

Storage Temperature \_\_\_\_\_ -55°C to + 125°C  
 Operating Temperature \_\_\_\_\_ -55°C to + 100°C  
 Lead Soldering Temperature  
 (1/16 inch (1.6mm) from case for 10 secs) 260°C

**INPUT DIODE**

Forward Current \_\_\_\_\_ 50mA  
 Reverse Voltage \_\_\_\_\_ 6V  
 Power Dissipation \_\_\_\_\_ 70mW

**OUTPUT TRANSISTOR**

Collector-emitter Voltage BV<sub>CEO</sub> \_\_\_\_\_ 30V  
 Emitter-collector Voltage BV<sub>ECO</sub> \_\_\_\_\_ 6V  
 Power Dissipation \_\_\_\_\_ 150mW

**POWER DISSIPATION**

Total Power Dissipation \_\_\_\_\_ 200mW  
 (derate linearly 2.67mW/°C above 25°C)

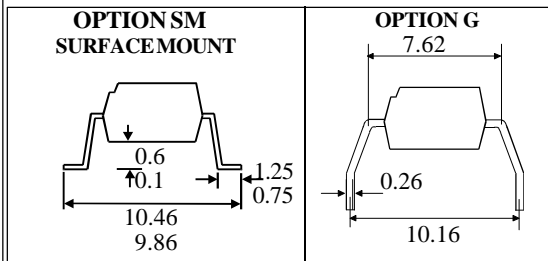

**ISOCOM COMPONENTS LTD**  
 Unit 25B, Park View Road West,  
 Park View Industrial Estate, Brenda Road  
 Hartlepool, Cleveland, TS25 1YD  
 Tel: (01429) 863609 Fax :(01429) 863581

**ISOCOM INC**  
 1024 S. Greenville Ave, Suite 240,  
 Allen, TX 75002 USA  
 Tel: (214) 495-0755 Fax: (214) 495-0901  
 e-mail info@isocom.com  
 http://www.isocom.com

**ELECTRICAL CHARACTERISTICS (  $T_A = 25^\circ\text{C}$  Unless otherwise noted )**

PARAMETER		MIN	TYP	MAX	UNITS	TEST CONDITION				
Input	Forward Voltage ( $V_F$ )	3		1.50	V	$I_F = 20\text{mA}$ $I_R = 10\mu\text{A}$ $V_R = 3\text{V}$				
	Reverse Voltage ( $V_R$ )				V					
	Reverse Current ( $I_R$ )			10	$\mu\text{A}$					
Output	Collector-emitter Breakdown ( $BV_{CEO}$ )	30			V	$I_C = 1\text{mA}$ (note 2) $I_E = 100\mu\text{A}$ $V_{CE} = 10\text{V}$				
	Emitter-collector Breakdown ( $BV_{ECO}$ )	6			V					
	Collector-emitter Dark Current ( $I_{CEO}$ )			100	nA					
Coupled	Current Transfer Ratio (CTR) (Note 2)	20				$10\text{mA } I_F, 10\text{V } V_{CE}$				
	MCT6						20	%		
	MCT61						50	%		
	MCT62						100	%		
	MCT66						6	%		
	Collector-emitter Saturation Voltage $V_{CESAT}$	5300			0.4	V	$16\text{mA } I_F, 2\text{mA } I_C$			
	MCT6,61,62							0.4	V	$40\text{mA } I_F, 2\text{mA } I_C$
	MCT66									
	Input to Output Isolation Voltage $V_{ISO}$	5300				$V_{RMS}$	See note 1			
	Input to Output Isolation Voltage $V_{ISO}$	7500				$V_{PK}$	See note 1			
	Input-output Isolation Resistance $R_{ISO}$	$5 \times 10^{10}$				$\Omega$	$V_{IO} = 500\text{V}$ (note 1)			
Output Rise Time, Fall Time $t_r, t_f$		2.4			$\mu\text{s}$	$I_C = 2\text{mA}, V_{CC} = 10\text{V}, R_L = 100\Omega$ (Fig. 1)				
Output Rise Time, Fall Time $t_r, t_f$		15			$\mu\text{s}$	$I_C = 2\text{mA}, V_{CC} = 10\text{V}, R_L = 1\text{k}\Omega$ (Fig. 2)				

Note 1 Measured with input leads shorted together and output leads shorted together.

Note 2 Special Selections are available on request. Please consult the factory.

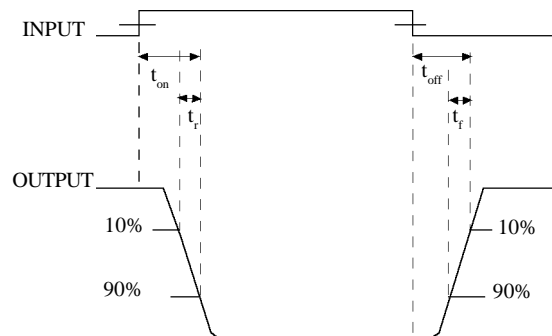
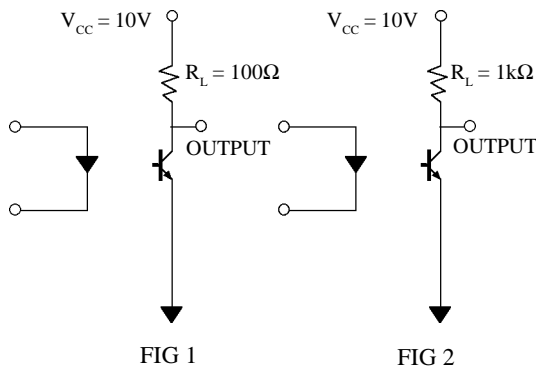

**Collector Power Dissipation vs. Ambient Temperature**

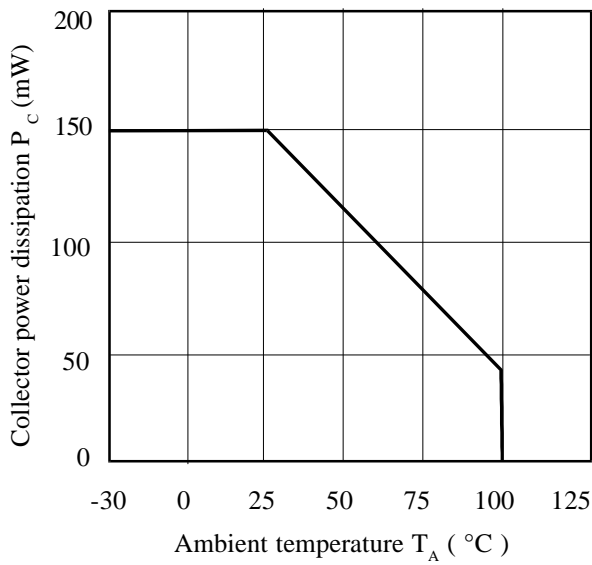

**Collector Current vs. Collector-emitter Voltage**

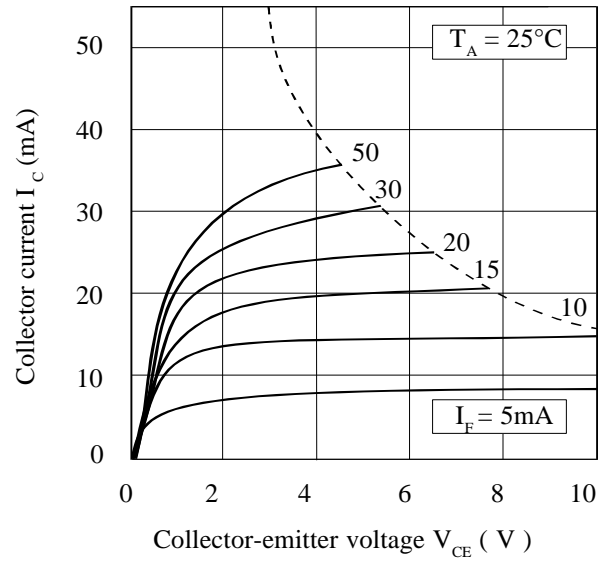

**Forward Current vs. Ambient Temperature**

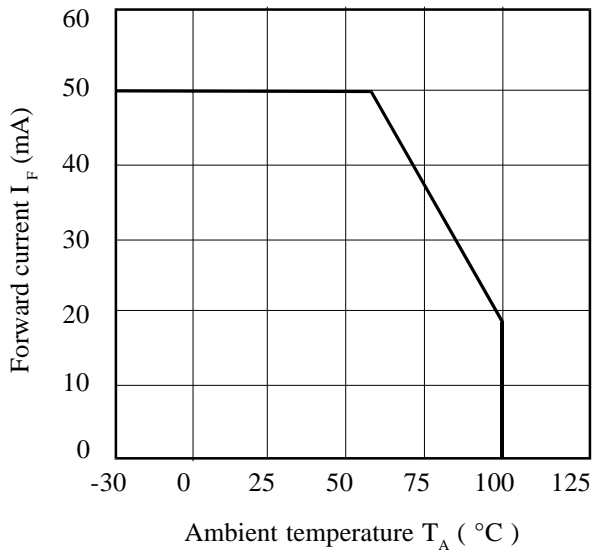

**Relative Current Transfer Ratio vs. Forward Current**

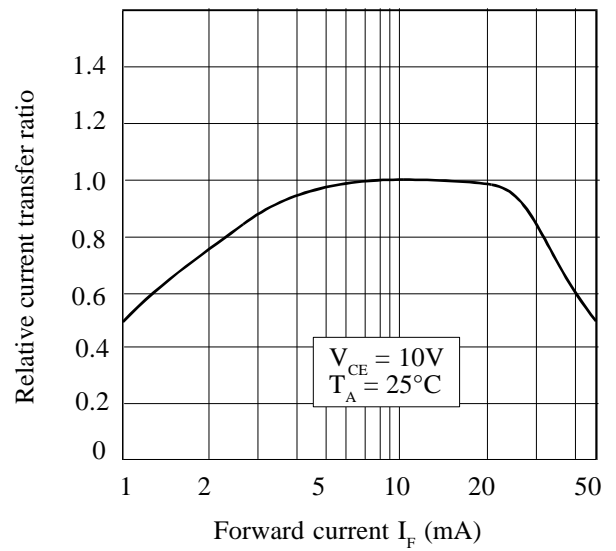

**Relative Current Transfer Ratio vs. Ambient Temperature**

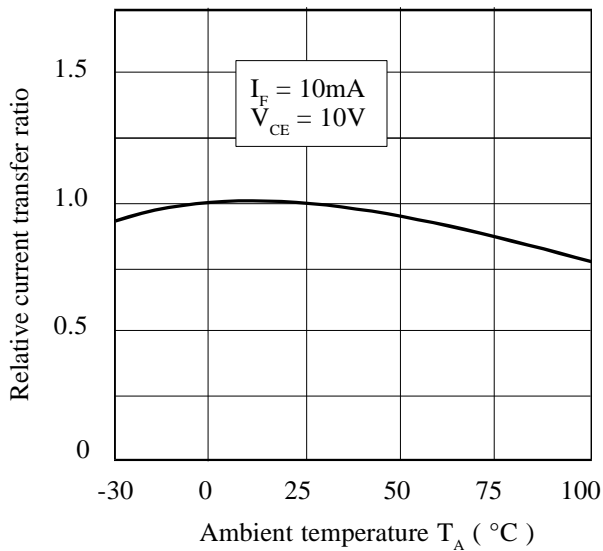

**Collector-emitter Saturation Voltage vs. Ambient Temperature**

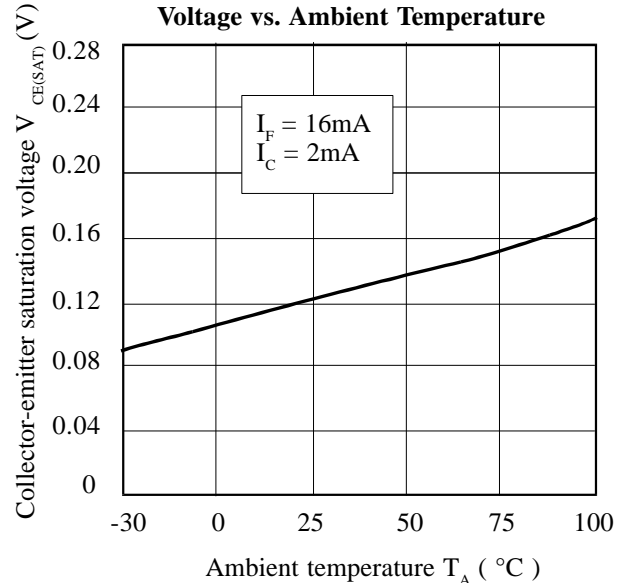

Copyright © Each Manufacturing Company.

All Datasheets cannot be modified without permission.

This datasheet has been download from :

[www.AllDataSheet.com](http://www.AllDataSheet.com)

100% Free DataSheet Search Site.

Free Download.

No Register.

Fast Search System.

[www.AllDataSheet.com](http://www.AllDataSheet.com)