

**Diode Modules**

**$I_{FRMS} = 2 \times 150 \text{ A}$**   
 **$I_{FAVM} = 2 \times 95 \text{ A}$**   
 **$V_{RRM} = 800-1800 \text{ V}$**

$V_{RSM}$ V	$V_{RRM}$ V	Type
900	800	MDD 56-08N1 B
1300	1200	MDD 56-12N1 B
1500	1400	MDD 56-14N1 B
1700	1600	MDD 56-16N1 B
1900	1800	MDD 56-18N1 B

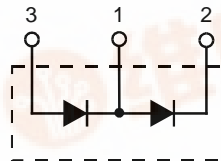

TO-240 AA

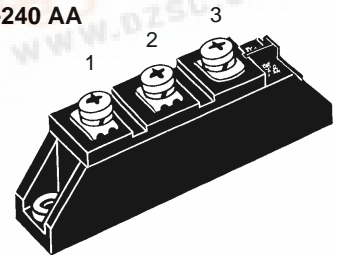

Symbol	Test Conditions	Maximum Ratings	
$I_{FRMS}$	$T_{VJ} = T_{VJM}$	150 A	
	$T_C = 75^\circ\text{C}; 180^\circ \text{ sine}$	95 A	
$I_{FAVM}$	$T_C = 100^\circ\text{C}; 180^\circ \text{ sine}$	71 A	
	$T_{VJ} = 45^\circ\text{C}; V_R = 0$	$t = 10 \text{ ms (50 Hz), sine}$ $t = 8.3 \text{ ms (60 Hz), sine}$	1400 A 1650 A
$I_{FSM}$	$T_{VJ} = T_{VJM}; V_R = 0$	$t = 10 \text{ ms (50 Hz), sine}$ $t = 8.3 \text{ ms (60 Hz), sine}$	1200 A 1400 A
	$\int i^2 dt$	$T_{VJ} = 45^\circ\text{C}; V_R = 0$	$t = 10 \text{ ms (50 Hz), sine}$ $t = 8.3 \text{ ms (60 Hz), sine}$
$T_{VJ}$		$T_{VJ} = T_{VJM}; V_R = 0$	$t = 10 \text{ ms (50 Hz), sine}$ $t = 8.3 \text{ ms (60 Hz), sine}$
	$T_{stg}$		
$V_{ISOL}$		50/60 Hz, RMS	$t = 1 \text{ min}$
	$I_{ISOL} \leq 1 \text{ mA}$	$t = 1 \text{ s}$	
$M_d$	Mounting torque (M5)		2.5-4/22-35 Nm/lb.in.
	Terminal connection torque (M5)		2.5-4/22-35 Nm/lb.in.
Weight	Typical including screws		90 g

**Features**

- International standard package JEDEC TO-240 AA
- Direct copper bonded  $\text{Al}_2\text{O}_3$  -ceramic base plate
- Planar passivated chips
- Isolation voltage 3600 V~
- UL registered, E 72873

**Applications**

- Supplies for DC power equipment
- DC supply for PWM inverter
- Field supply for DC motors
- Battery DC power supplies

**Advantages**

- Space and weight savings
- Simple mounting
- Improved temperature and power cycling
- Reduced protection circuits

Symbol	Test Conditions	Characteristic Values
$I_R$	$T_{VJ} = T_{VJM}; V_R = V_{RRM}$	10 mA
$V_F$	$I_F = 200 \text{ A}; T_{VJ} = 25^\circ\text{C}$	1.48 V
$V_{T0}$	For power-loss calculations only	0.8 V
$r_T$	$T_{VJ} = T_{VJM}$	3 mΩ
$Q_S$	$T_{VJ} = 125^\circ\text{C}; I_F = 50 \text{ A}, -di/dt = 3 \text{ A}/\mu\text{s}$	100 μC
$I_{RM}$		24 A
$R_{thJC}$	per diode; DC current	0.51 K/W
	per module	other values see Fig. 6/7
$R_{thJK}$	per diode; DC current	
	per module	0.355 K/W
$d_s$	Creepage distance on surface	12.7 mm
$d_A$	Strike distance through air	9.6 mm
$a$	Maximum allowable acceleration	50 m/s <sup>2</sup>

**Dimensions in mm (1 mm = 0.0394")**

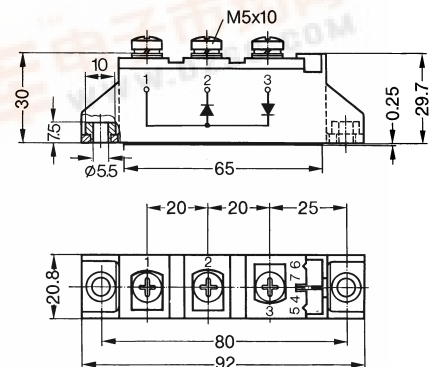

Data according to IEC 60747 and refer to a single diode unless otherwise stated. IXYS reserves the right to change limits, test conditions and dimensions



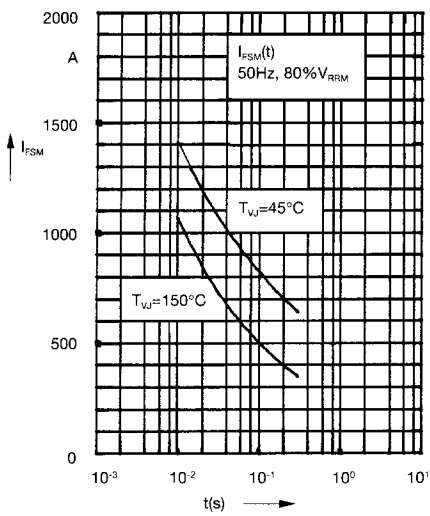

Fig. 1 Surge overload current  
 $I_{FSM}$ : Crest value,  $t$ : duration

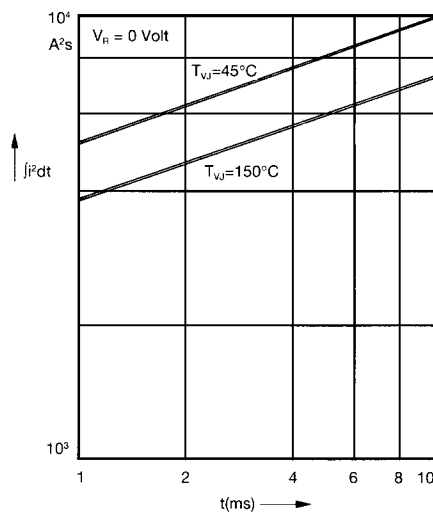

Fig. 2  $\int i^2 dt$  versus time (1-10 ms)

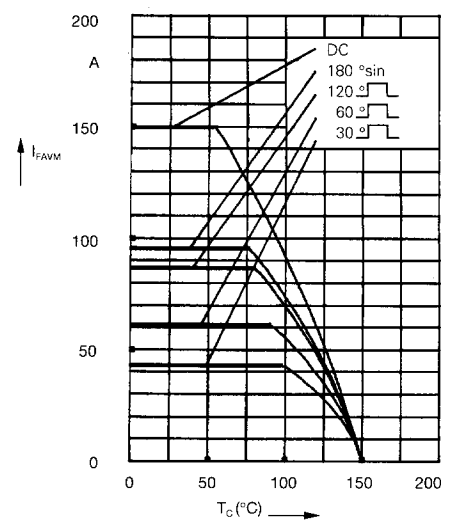

Fig. 2a Maximum forward current at case temperature

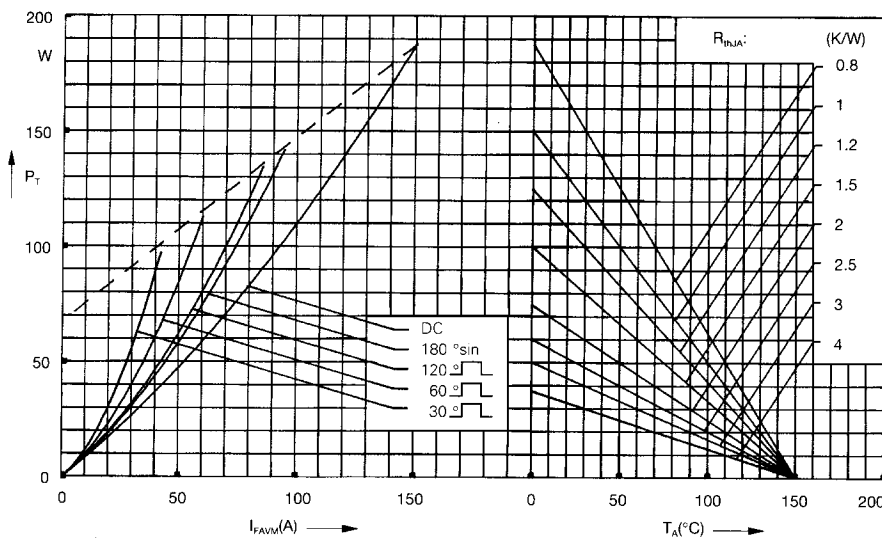

Fig. 3 Power dissipation versus forward current and ambient temperature (per diode)

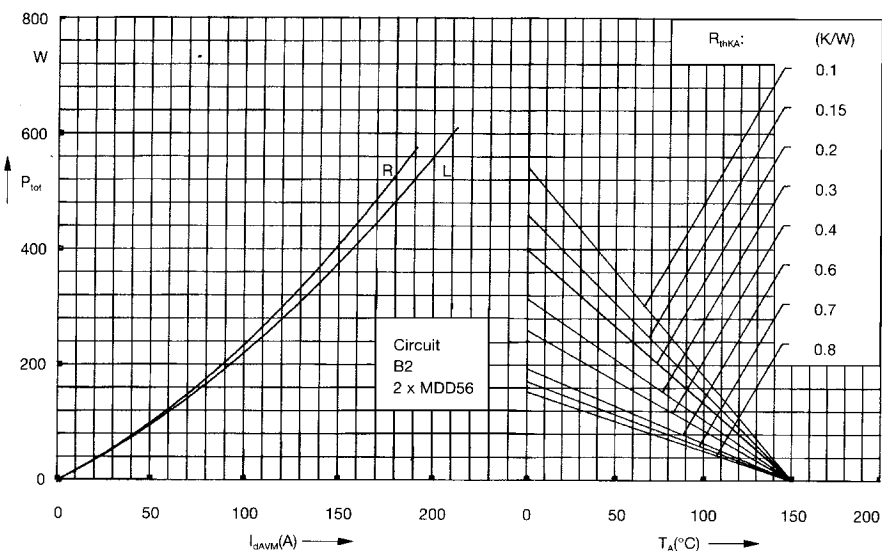

Fig. 4 Single phase rectifier bridge:  
 Power dissipation versus direct output current and ambient temperature  
 R = resistive load  
 L = inductive load

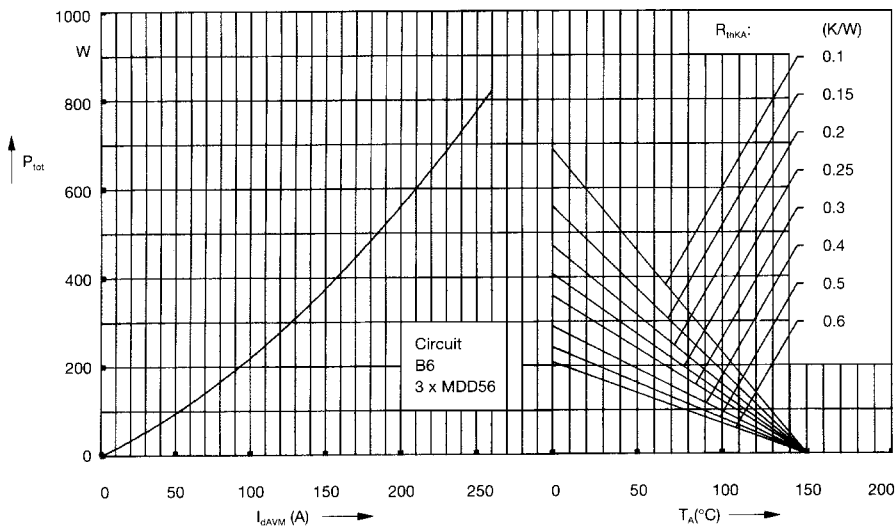

Fig. 5 Three phase rectifier bridge: Power dissipation versus direct output current and ambient temperature

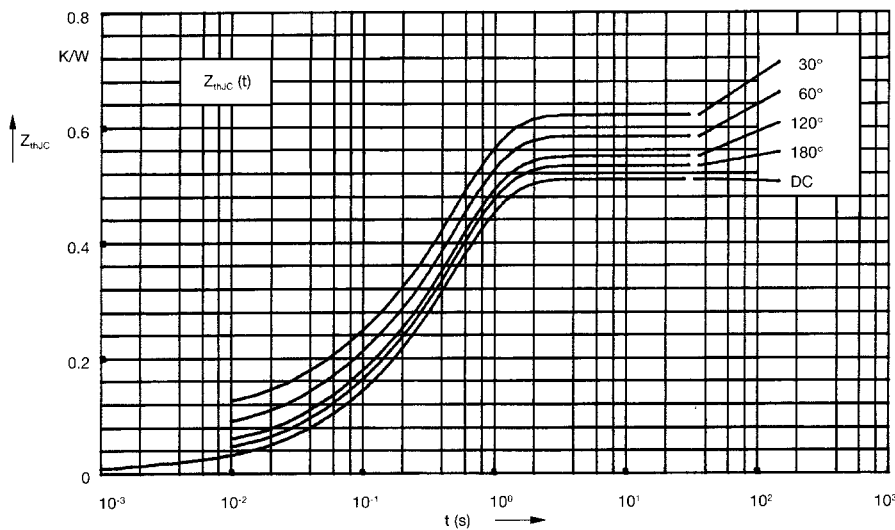

Fig. 6 Transient thermal impedance junction to case (per diode)

$R_{thJC}$  for various conduction angles d:

d	$R_{thJC}$ (K/W)
DC	0.51
180°	0.53
120°	0.55
60°	0.58
30°	0.62

Constants for  $Z_{thJC}$  calculation:

i	$R_{thi}$ (K/W)	$t_i$ (s)
1	0.013	0.0015
2	0.055	0.045
3	0.442	0.485

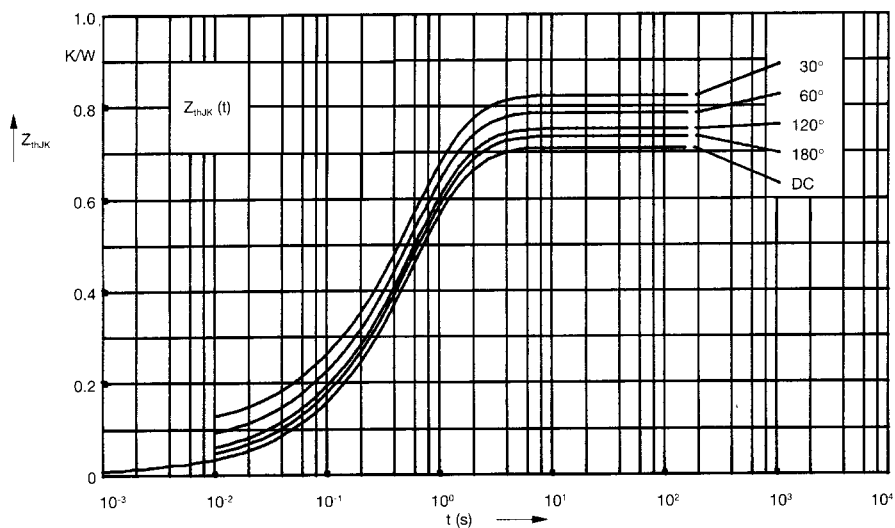

Fig. 7 Transient thermal impedance junction to heatsink (per diode)

$R_{thJK}$  for various conduction angles d:

d	$R_{thJK}$ (K/W)
DC	0.71
180°	0.73
120°	0.75
60°	0.78
30°	0.82

Constants for  $Z_{thJK}$  calculation:

i	$R_{thi}$ (K/W)	$t_i$ (s)
1	0.013	0.0015
2	0.055	0.045
3	0.442	0.485
4	0.2	1.25