

Surface Mount

Dual Matched MMIC Amplifiers

NEW!

MERA-7456

50Ω High Dynamic Range DC to 1 GHz

Features

- Two matched amplifiers in one package
- InGaP HBT IF and RF amplifier
- frequency range, DC to 1 GHz, usable to 4 GHz
- high gain, 25.1 dB typ. at 100 MHz
- up to +19 dBm typ. output power at 100 MHz
- high IP3, +36 dBm at 100 MHz
- low noise figure, 2.7 dB typ.
- low thermal resistance
- transient protected
- patent pending
- useable as balanced and push pull amplifier

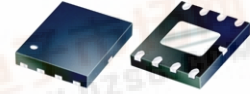

CASE STYLE: DL1020
PRICE: \$ 4.70 ea. QTY (25)

Applications

- cellular
- catv
- VHF & UHF communication receivers & transmitters

Electrical Specifications @ 25°C

Freq.* (GHz)	Gain, dB Typical A1, A2					Min. @ 1GHz	Maximum Power (dBm)				Dynamic Range				VSWR (:1) Typ.	Maximum Rating**	DC Operating Power Pin 5, Pin 8	Thermal Resistance θjc, typ. °C/W	matching ¹											
	over frequency, GHz						Output (1 dB Comp.) Typ.	Input (no dmg.)	NF (dB) Typ.	IP3 (dBm) Typ.	In	Out	I P	Current (mA)					Volt	Amplitude Unbalance between 2 amps (dB)	Phase Unbalance between 2 amps (deg.)									
f _L -f _U	0.1	1	2	3	4		0.1 GHz	1.0 GHz	2.0 GHz	0.1GHz		0.1 GHz	0.5 GHz	1.0 GHz	In	Out	mA	mW	Typ	Min	Max	DC-1 GHz	1-4 GHz	DC-1 GHz	1-4 GHz					
DC-1	25.1	22.5	18.6	14.2	9.4	20	19	18.2	14.4	18	10	2.7	36	35	32	1.3	2.0	130	700	80	4.8	4.3	5.3	120	0.1	0.3	0.1	—	0.6	1.0

* Guaranteed specification DC-1GHz. Low frequency cutoff determined by external coupling capacitors.
** Permanent damage may occur if any of these limits are exceeded. These ratings are not intended for continuous normal operation. Reliability predictions and normal operating conditions are applicable at current specified.

1. For test method, see application note AN-60-032

Pin Connections

PORT	
RF IN 1	1
RF OUT 1	8
RF IN 2	4
RF OUT 2	5
DC 1	8
DC 2	5
GROUND	2,3,6,7 and paddle

MTTF vs. Junction Temperature

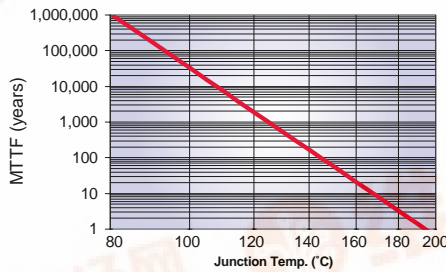

Maximum Ratings²

Operating Case Temperature -45°C to 85°C

Storage Temperature -55°C to 100°C

2. See application note AN-60-032 for adequate heat sinking of paddle.

typical biasing configuration

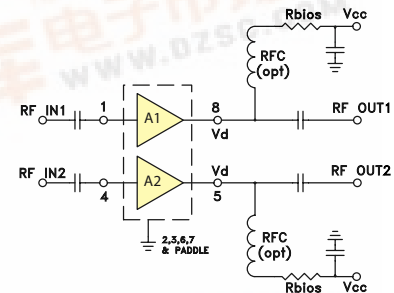

Outline Drawing

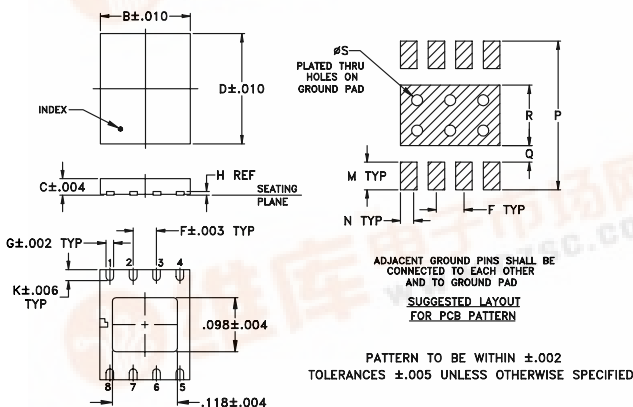

Demo Board MCL P/N: TB-293 Suggested PCB Layout (PL-164)

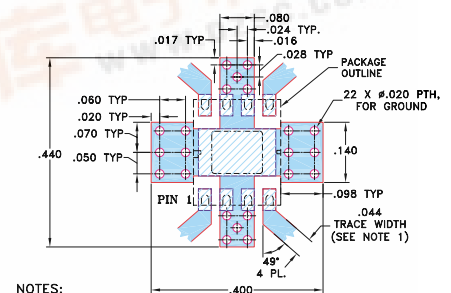

NOTES:

1. TRACE WIDTH IS SHOWN FOR ROGERS RO4350 WITH DIELECTRIC THICKNESS .020 ± .0015. COPPER: 1/2 OZ. EACH SIDE. FOR OTHER MATERIALS TRACE WIDTH MAY NEED TO BE MODIFIED.
2. BOTTOM SIDE OF THE PCB IS CONTINUOUS GROUND PLANE.

- DENOTES PCB COPPER LAYOUT
- DENOTES COPPER LAND PATTERN FREE OF SOLDER MASK

Outline Dimensions (inch/mm)

	B	C	D	E	F	G	H	J	K	L	M	N	P	Q	R	S	wt.
	.193	.035	.236	—	.050	.017	.008	—	.024	—	.050	.030	.270	.030	.110	.020	grams
	4.91	0.91	6.00	—	1.27	0.43	0.20	—	0.60	—	1.27	0.76	6.86	0.76	2.79	0.51	.08



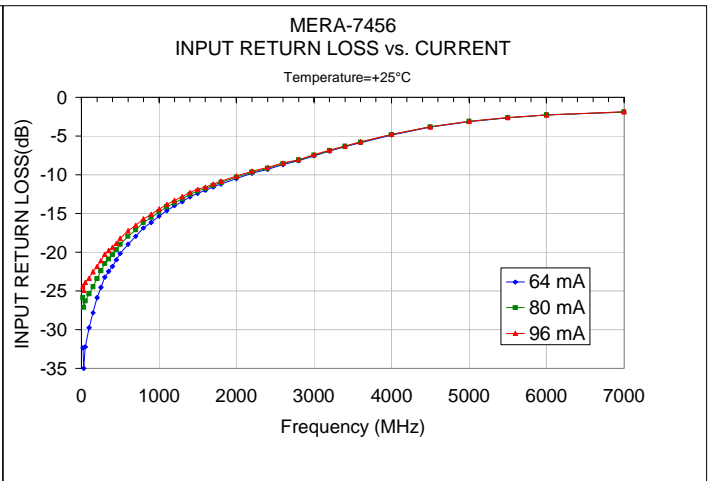
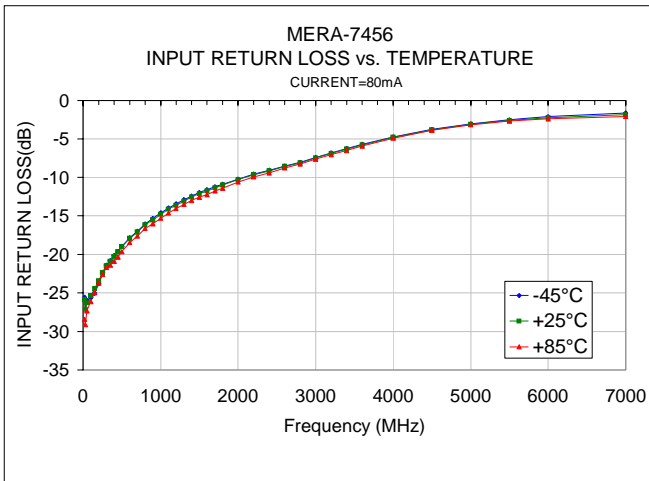
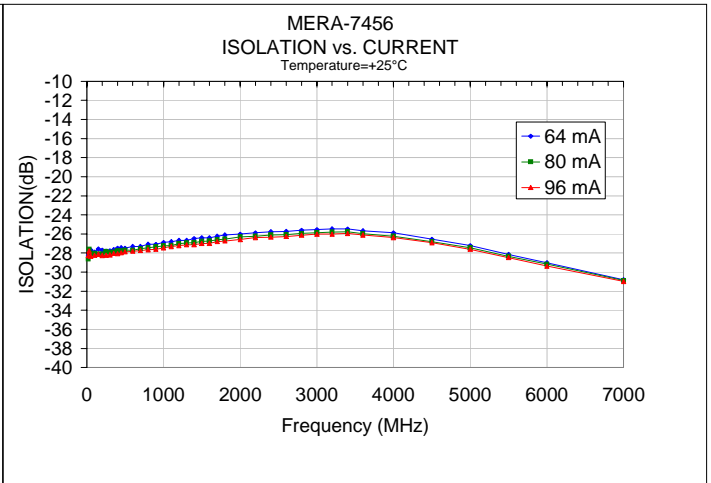
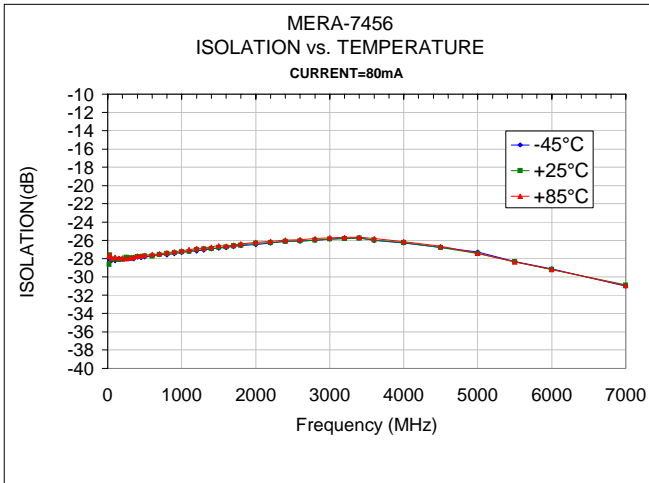
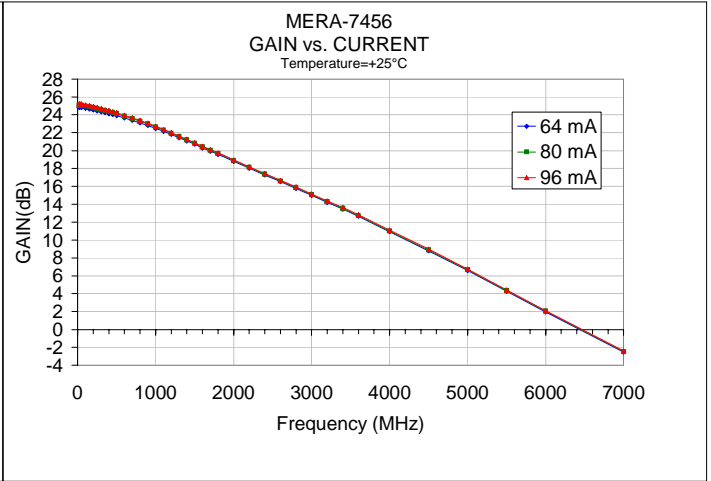
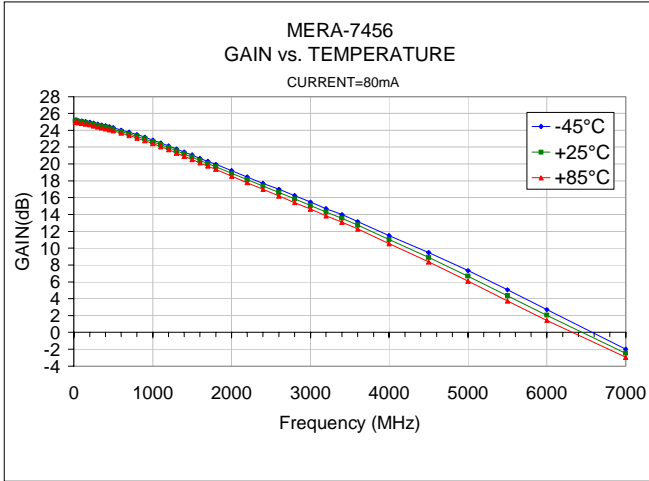

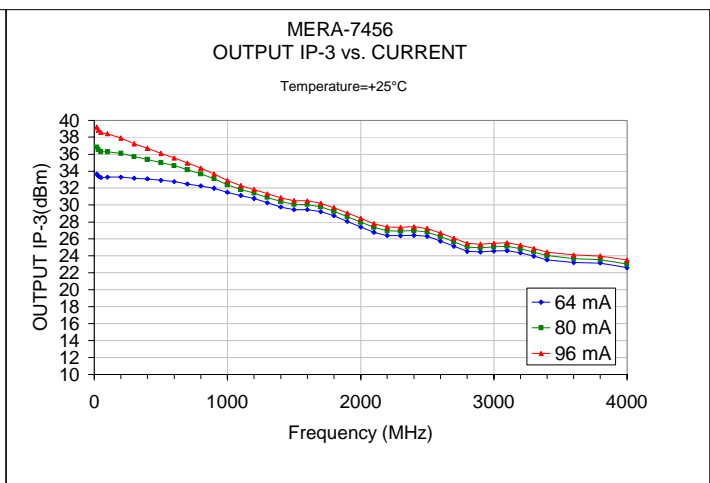
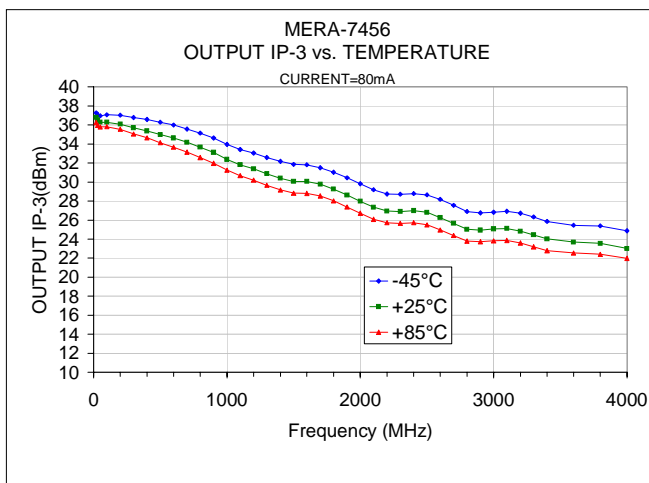
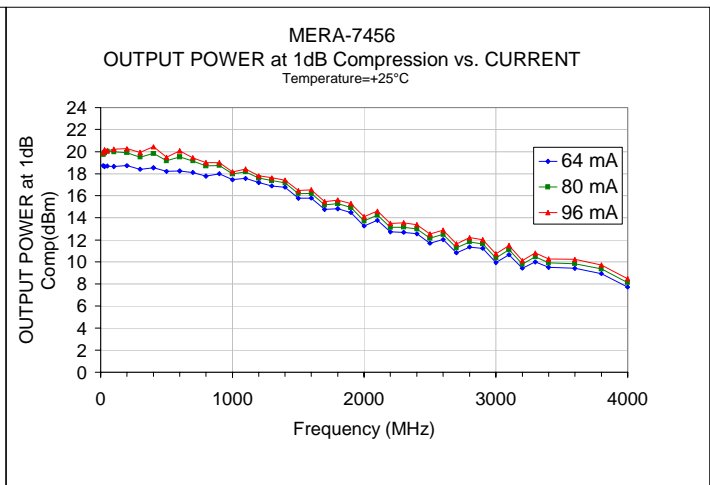
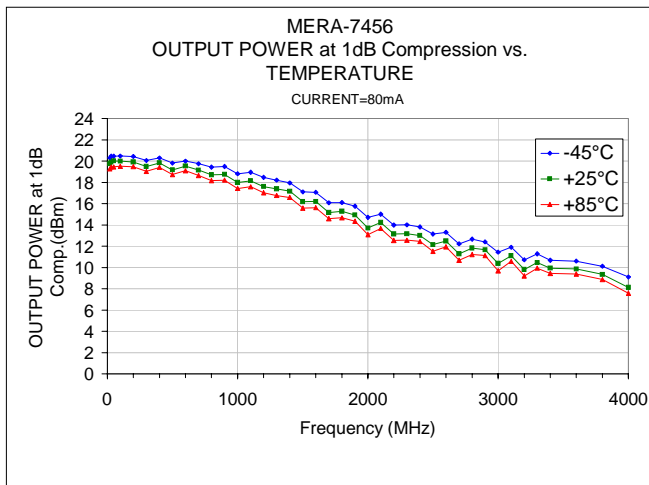
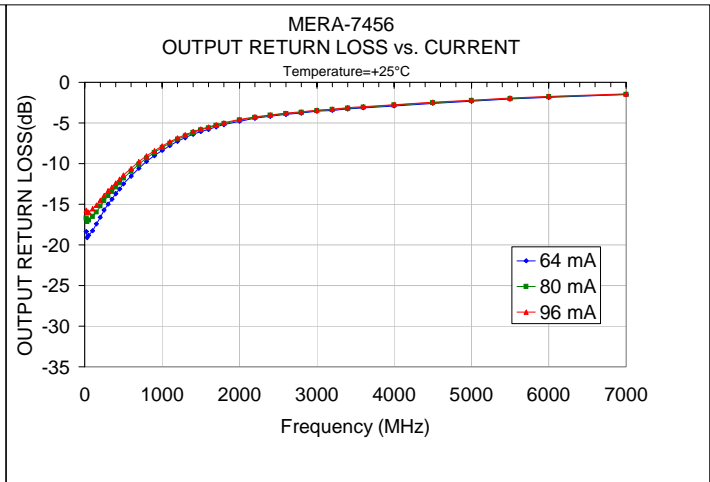
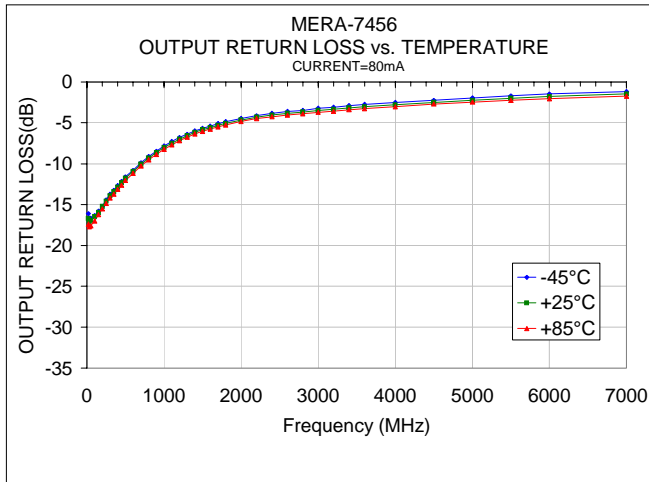

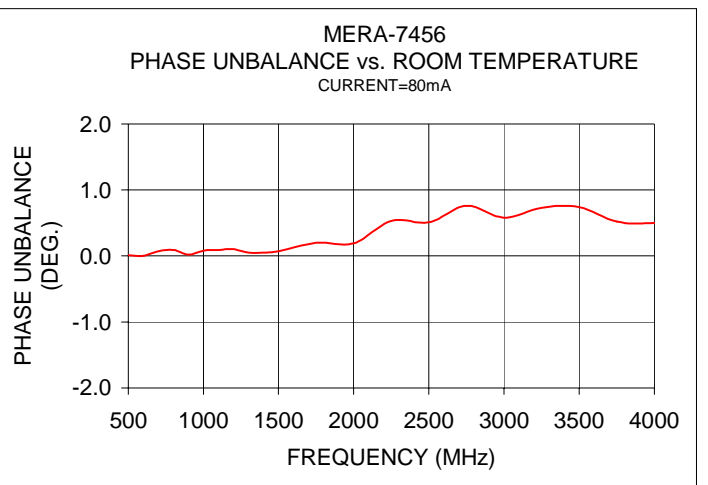
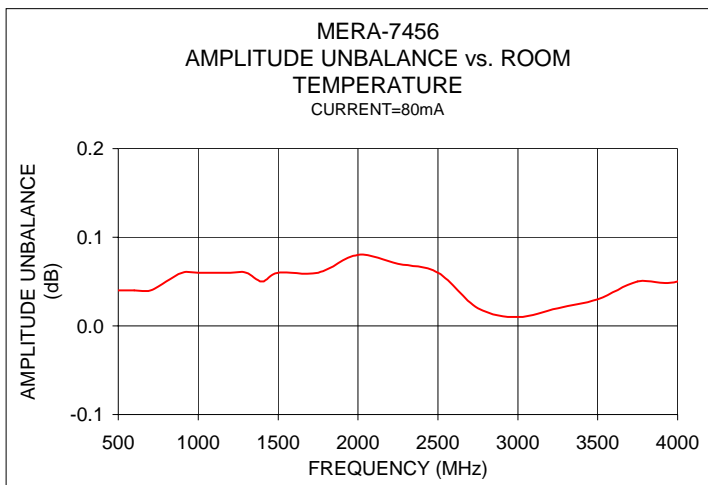
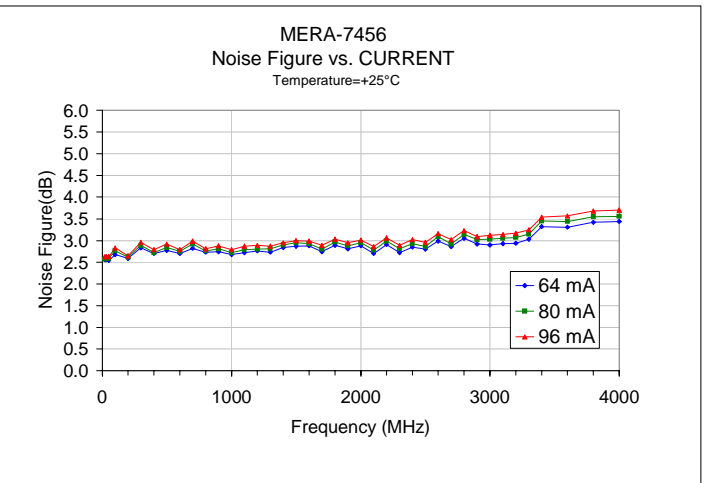
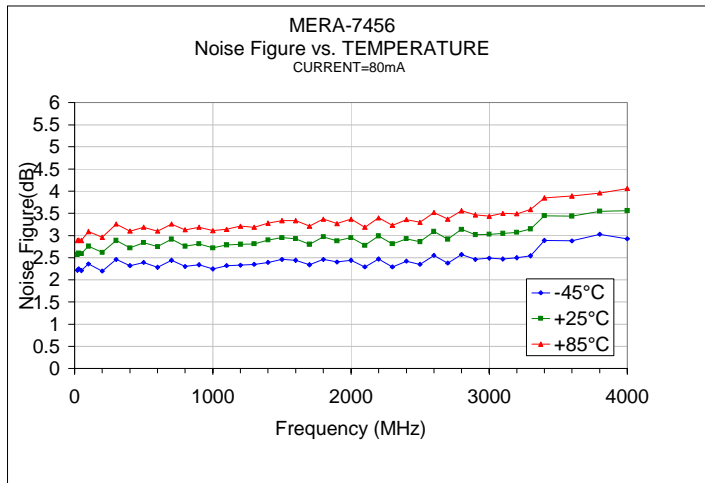

S-PARAMETERS

MERA-7456

Freq. MHz	S11 (Input Return Loss)			S21 (Power Gain)			S12 (Isolation Out-in)			S22 (Output Return Loss)			K
	dB	Mag	Angle	dB	Mag	Angle	dB	Mag	Angle	dB	Mag	Angle	
20.00	-36.68	0.01	-152.95	24.91	17.60	175.49	-27.81	0.04	-2.57	-20.02	0.10	177.43	1.05
30.00	-38.06	0.01	-171.41	24.97	17.72	174.47	-27.68	0.04	-3.21	-19.27	0.11	-179.27	1.04
50.00	-35.29	0.02	-155.23	24.92	17.62	171.16	-27.87	0.04	-5.30	-19.58	0.10	-175.29	1.05
100.00	-32.12	0.02	-139.13	24.87	17.52	163.20	-27.85	0.04	-8.52	-18.70	0.12	-173.03	1.05
150.00	-30.48	0.03	-142.13	24.81	17.40	155.36	-27.71	0.04	-11.74	-17.89	0.13	-171.49	1.04
200.00	-27.36	0.04	-149.92	24.72	17.22	147.16	-27.81	0.04	-16.69	-16.84	0.14	-172.36	1.05
250.00	-25.79	0.05	-151.71	24.61	17.00	139.23	-27.92	0.04	-19.66	-15.81	0.16	-174.89	1.05
300.00	-23.89	0.06	-162.37	24.51	16.81	131.32	-27.63	0.04	-24.08	-15.09	0.18	-177.83	1.04
350.00	-23.36	0.07	-169.13	24.42	16.63	123.64	-27.64	0.04	-28.35	-14.33	0.19	-177.66	1.04
400.00	-22.50	0.07	-174.56	24.31	16.42	115.94	-27.65	0.04	-32.62	-13.61	0.21	-172.88	1.04
450.00	-21.75	0.08	-178.30	24.20	16.22	108.25	-27.50	0.04	-36.85	-13.00	0.22	-167.83	1.03
500.00	-21.03	0.09	-169.99	24.08	16.00	100.62	-27.58	0.04	-41.51	-12.34	0.24	-161.47	1.03
600.00	-19.61	0.10	-153.97	23.81	15.51	85.48	-27.37	0.04	-49.92	-11.22	0.27	-149.48	1.02
700.00	-18.47	0.12	-139.35	23.51	14.98	70.47	-27.27	0.04	-59.20	-10.23	0.31	-136.84	1.02
800.00	-17.42	0.13	-124.90	23.24	14.52	55.61	-27.07	0.04	-67.91	-9.47	0.34	-124.59	1.00
900.00	-16.41	0.15	-111.53	22.93	14.01	40.94	-26.91	0.05	-77.38	-8.74	0.37	-111.78	1.00
1000.00	-15.65	0.17	-97.34	22.60	13.49	26.53	-26.84	0.05	-86.39	-8.14	0.39	-98.87	0.99
1100.00	-14.82	0.18	-84.36	22.26	12.97	12.01	-26.78	0.05	-95.91	-7.59	0.42	-86.02	0.99
1200.00	-14.12	0.20	-71.15	21.90	12.45	-2.07	-26.65	0.05	-104.89	-7.09	0.44	-73.40	0.99
1300.00	-13.42	0.21	-58.45	21.53	11.93	-16.16	-26.51	0.05	-114.31	-6.66	0.46	-60.91	0.98
1400.00	-12.79	0.23	-45.29	21.17	11.44	-29.99	-26.39	0.05	-123.88	-6.28	0.49	-48.28	0.98
1500.00	-12.28	0.24	-33.16	20.79	10.95	-43.78	-26.30	0.05	-133.56	-5.93	0.51	-35.74	0.98
1600.00	-11.82	0.26	-20.77	20.41	10.48	-57.28	-26.21	0.05	-143.41	-5.62	0.52	-23.12	0.98
1700.00	-11.28	0.27	-8.42	20.01	10.01	-70.87	-26.18	0.05	-153.08	-5.36	0.54	-10.83	0.98
1800.00	-10.84	0.29	-4.59	19.61	9.56	-84.32	-26.03	0.05	-162.56	-5.10	0.56	-1.66	0.98
2000.00	-10.00	0.32	-28.82	18.82	8.73	-110.79	-25.93	0.05	-177.04	-4.69	0.58	-26.23	0.99
2200.00	-9.17	0.35	-52.88	18.01	7.95	-136.87	-25.79	0.05	-157.35	-4.33	0.61	-50.89	1.00
2400.00	-8.32	0.38	-76.83	17.19	7.24	-162.79	-25.76	0.05	-136.84	-4.02	0.63	-75.36	1.02
2600.00	-7.53	0.42	-100.64	16.35	6.57	-171.56	-25.73	0.05	-116.63	-3.71	0.65	-99.83	1.04
2800.00	-6.83	0.46	-123.98	15.47	5.94	-146.25	-25.84	0.05	-96.02	-3.45	0.67	-123.97	1.07
3000.00	-6.20	0.49	-146.78	14.54	5.33	-121.08	-25.89	0.05	-75.94	-3.18	0.69	-147.89	1.09
3200.00	-5.61	0.52	-169.30	13.59	4.78	-96.45	-25.97	0.05	-55.46	-2.93	0.71	-171.19	1.11
3400.00	-5.06	0.56	-168.41	12.63	4.28	-72.21	-26.27	0.05	-33.64	-2.67	0.74	-165.76	1.14
3600.00	-4.57	0.59	-146.57	11.60	3.80	-48.42	-26.64	0.05	-14.08	-2.49	0.75	-143.55	1.19
4000.00	-3.76	0.65	-104.60	9.59	3.02	-2.32	-27.35	0.04	-25.01	-2.13	0.78	-101.70	1.27
4500.00	-3.10	0.70	-54.97	7.08	2.26	-52.72	-28.44	0.04	-72.83	-1.85	0.81	-53.15	1.41
5000.00	-2.67	0.74	-7.34	4.79	1.74	-104.83	-29.44	0.03	-115.98	-1.68	0.82	-7.97	1.63
5500.00	-2.36	0.76	-38.87	2.70	1.36	-155.57	-30.04	0.03	-157.21	-1.62	0.83	-35.72	1.87
6000.00	-2.20	0.78	-83.99	0.73	1.09	-154.94	-30.19	0.03	-160.62	-1.65	0.83	-78.60	2.19
7000.00	-1.91	0.80	-171.06	-2.83	0.72	-57.91	-30.41	0.03	-68.06	-1.72	0.82	-164.43	2.81