

# MGF1902B

## TAPE CARRIER LOW NOISE GaAs FET

### DESCRIPTION

The MGF1902B is a low noise GaAs FET with an N-channel Schottky gate, which is designed for use in S to X band amplifiers and oscillators. The hermetically sealed metal-ceramic package assures minimum parasitic losses, and has a configuration suitable for microstrip circuits. The MGF1902B is mounted in the Super 12 tape, and is electrically equivalent to MGF1302.

### FEATURES

- Low noise figure  $NF_{min} = 4.0 \text{ dB (MAX.) @ } f = 12 \text{ GHz}$
- High associated gain  $G_s = 5.0 \text{ dB (MIN.) @ } f = 12 \text{ GHz}$

### APPLICATION

S to X band low noise amplifiers and oscillators

### QUALITY GRADE

- GG

### RECOMMENDED BIAS CONDITIONS

- $V_{DS} = 3V$
- $I_D = 10mA$
- Refer to Bias Procedure

### OUTLINE DRAWING

Unit: millimeters (inches)

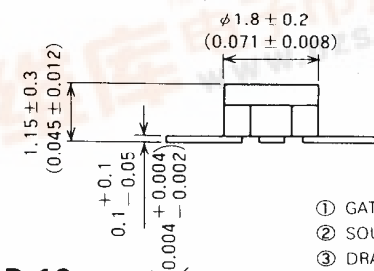
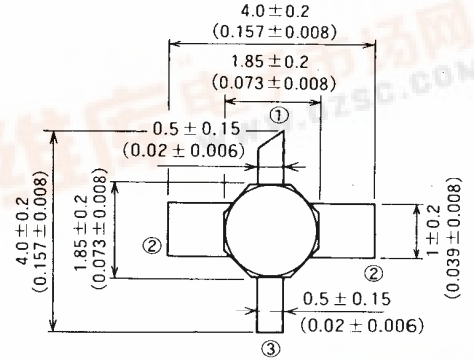

- ① GATE
- ② SOURCE
- ③ DRAIN

GD-16

### ABSOLUTE MAXIMUM RATINGS (Ta = 25°C)

Symbol	Parameter	Ratings	Unit
$V_{GDO}$	Gate to drain voltage	-6	V
$V_{GSO}$	Gate to source voltage	-6	V
$I_D$	Drain current	100	mA
$P_T$	Total power dissipation *1	360	mW
$T_{ch}$	Channel temperature	175	°C
$T_{stg}$	Storage temperature	-55 ~ +175	°C
$T_{stg}(T)$	Storage temperature in tape	-30 ~ +40	°C

\*1:  $T_c = 25^\circ C$

### ELECTRICAL CHARACTERISTICS (Ta = 25°C)

Symbol	Parameter	Test conditions	Limits			Unit
			Min	Typ	Max	
$V_{(BR)GDO}$	Gate to drain breakdown voltage	$I_G = -100 \mu A$	-6	—	—	V
$V_{(BR)GSO}$	Gate to source breakdown voltage	$I_G = -100 \mu A$	-6	—	—	V
$I_{GSS}$	Gate to source leakage current	$V_{GS} = -3V, V_{DS} = 0V$	—	—	10	$\mu A$
$I_{DSS}$	Saturated drain current	$V_{GS} = 0V, V_{DS} = 3V$	30	60	100	mA
$V_{GS(off)}$	Gate to source cut-off voltage	$V_{DS} = 3V, I_D = 100 \mu A$	-0.3	—	-3.5	V
$g_m$	Transconductance	$V_{DS} = 3V, I_D = 10mA$	25	45	—	mS
$G_s$	Associated gain	$V_{DS} = 3V, I_D = 10mA, f = 12GHz$	5	—	—	dB
$NF_{min}$	Minimum noise figure	$V_{DS} = 3V, I_D = 10mA, f = 12GHz$	—	—	4.0	dB
$R_{th}(ch-a)$	Thermal resistance *1	$\Delta V_f$ method	—	—	416	°C/W

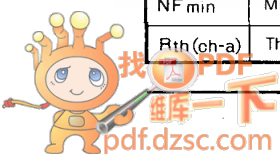

**TAPE CARRIER LOW NOISE GaAs FET**

**TYPICAL CHARACTERISTICS**

**$I_D$  vs.  $V_{GS}$**

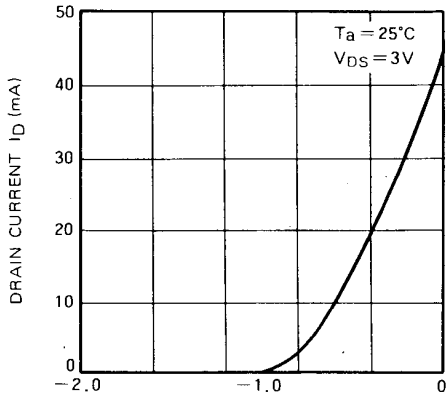

GATE TO SOURCE VOLTAGE  $V_{GS}$  (V)

**$I_D$  vs.  $V_{DS}$**

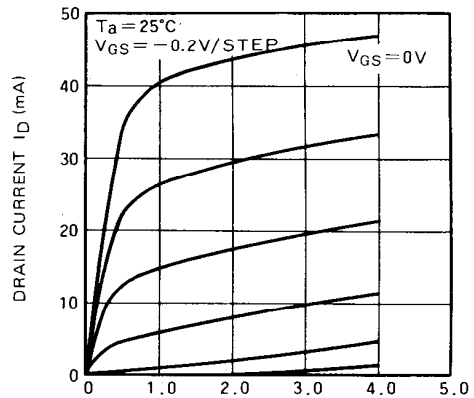

DRAIN TO SOURCE VOLTAGE  $V_{DS}$  (V)

**NF &  $G_s$  vs.  $I_D$**

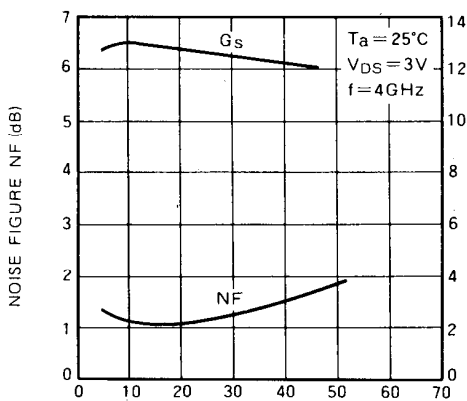

DRAIN CURRENT  $I_D$  (mA)

**$NF_{min}$  &  $G_s$  vs.  $f$**

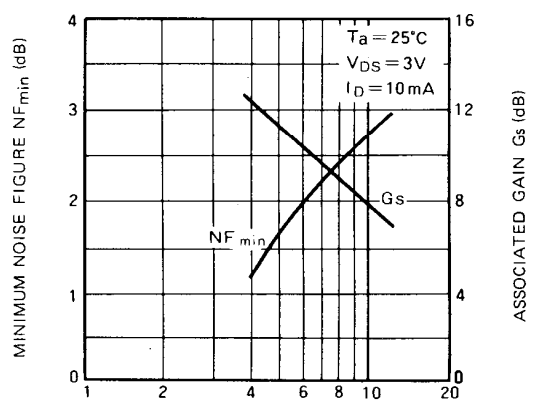

FREQUENCY  $f$  (GHz)

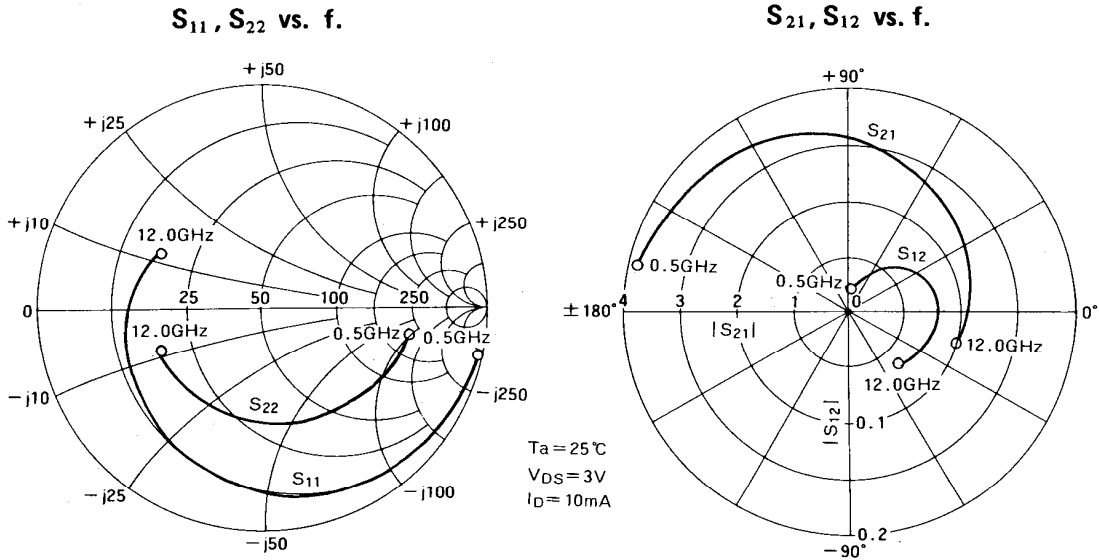

**S PARAMETERS** ( $T_a=25^\circ\text{C}$ ,  $V_{DS}=3\text{V}$ ,  $I_D=10\text{mA}$ )

Freq. (GHz)	S <sub>11</sub>		S <sub>21</sub>		S <sub>12</sub>		S <sub>22</sub>		K	MSG/MAG (dB)
	Mag.	Ang.	Mag.	Ang.	Mag.	Ang.	Mag.	Ang.		
0.5	0.997	-13.3	3.809	167.6	0.019	80.1	0.664	-10.3	0.042	23.0
1.0	0.975	-23.1	3.727	158.4	0.026	73.1	0.650	-17.3	0.180	21.6
1.5	0.952	-32.8	3.644	149.1	0.033	66.0	0.636	-24.2	0.271	20.4
2.0	0.929	-42.5	3.561	139.9	0.040	58.9	0.622	-31.2	0.341	19.5
2.5	0.906	-52.2	3.478	130.7	0.047	51.8	0.608	-38.2	0.398	18.7
3.0	0.884	-62.0	3.396	121.5	0.054	44.8	0.594	-45.2	0.449	18.0
3.5	0.861	-71.7	3.313	112.2	0.061	37.7	0.580	-52.1	0.494	17.3
4.0	0.838	-81.4	3.230	103.0	0.068	30.6	0.566	-59.1	0.537	16.8
4.5	0.811	-90.9	3.124	94.4	0.071	24.5	0.551	-66.2	0.604	16.5
5.0	0.783	-100.3	3.018	85.8	0.074	18.5	0.537	-73.3	0.674	16.1
5.5	0.756	-109.8	2.913	77.2	0.076	12.4	0.522	-80.3	0.746	15.8
6.0	0.729	-119.2	2.807	68.6	0.079	6.3	0.507	-87.4	0.822	15.5
6.5	0.709	-127.0	2.710	61.1	0.078	1.1	0.503	-93.7	0.902	15.4
7.0	0.689	-134.9	2.614	53.5	0.078	-4.1	0.499	-100.1	0.989	15.3
7.5	0.670	-142.7	2.517	46.0	0.077	-9.2	0.494	-106.4	1.085	13.4
8.0	0.650	-150.5	2.421	38.4	0.076	-14.4	0.490	-112.7	1.190	12.4
8.5	0.633	-157.6	2.364	31.5	0.075	-18.1	0.487	-118.2	1.271	11.8
9.0	0.617	-164.7	2.308	24.5	0.074	-21.9	0.485	-123.7	1.357	11.3
9.5	0.600	-171.8	2.251	17.6	0.074	-25.6	0.482	-129.2	1.449	10.9
10.0	0.584	-178.9	2.194	10.6	0.073	-29.3	0.479	-134.7	1.547	10.4
10.5	0.568	173.3	2.149	3.4	0.072	-33.9	0.483	-140.1	1.641	10.1
11.0	0.551	165.5	2.103	-3.9	0.071	-38.4	0.487	-145.5	1.739	9.7
11.5	0.535	157.7	2.058	-11.1	0.069	-43.0	0.491	-150.8	1.844	9.4
12.0	0.519	149.9	2.012	-18.3	0.068	-47.5	0.495	-156.2	1.954	9.1

**MGF1902B**

**TAPE CARRIER LOW NOISE GaAs FET**

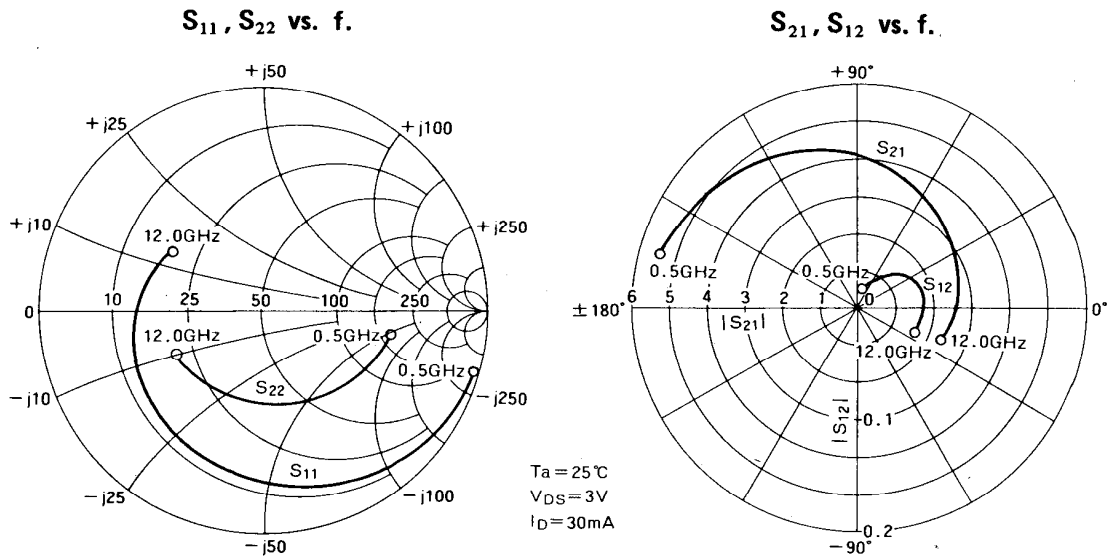

**S PARAMETERS** (Ta = 25°C, V<sub>DS</sub> = 3V, I<sub>D</sub> = 30mA)

Freq. (GHz)	S <sub>11</sub>		S <sub>21</sub>		S <sub>12</sub>		S <sub>22</sub>		K	MSG/MAG (dB)
	Mag.	Ang.	Mag.	Ang.	Mag.	Ang.	Mag.	Ang.		
0.5	0.995	-16.4	5.393	164.9	0.017	78.7	0.579	-11.4	0.067	25.0
1.0	0.966	-27.1	5.224	155.4	0.022	72.1	0.564	-18.3	0.233	23.8
1.5	0.936	-37.7	5.056	145.8	0.027	65.4	0.549	-25.1	0.350	22.7
2.0	0.906	-48.3	4.888	136.3	0.032	58.8	0.534	-32.0	0.442	21.8
2.5	0.876	-48.9	4.720	126.8	0.037	52.2	0.519	-38.9	0.520	21.1
3.0	0.847	-69.6	7.552	117.3	0.042	45.6	0.504	-45.8	0.589	20.3
3.5	0.817	-80.2	4.383	107.7	0.047	38.9	0.489	-52.6	0.652	19.7
4.0	0.787	-90.8	4.215	98.2	0.052	32.3	0.474	-59.5	0.713	19.1
4.5	0.758	-100.6	4.040	89.7	0.054	27.5	0.461	-66.2	0.800	18.8
5.0	0.729	-110.3	3.865	81.2	0.055	22.6	0.447	-72.9	0.893	18.5
5.5	0.700	-120.1	3.690	72.7	0.056	17.8	0.433	-79.6	0.993	18.2
6.0	0.671	-129.8	3.515	64.2	0.058	12.9	0.420	-86.3	1.101	15.9
6.5	0.652	-137.9	3.378	56.8	0.058	9.4	0.418	-92.5	1.188	15.0
7.0	0.632	-146.0	3.241	49.5	0.058	5.9	0.417	-98.7	1.282	14.3
7.5	0.612	-154.0	3.103	42.1	0.058	2.3	0.416	-104.9	1.386	13.6
8.0	0.593	-162.1	2.966	34.7	0.058	-1.2	0.414	-111.1	1.501	12.9
8.5	0.577	-177.0	2.883	27.8	0.057	-3.4	0.414	-116.3	1.596	12.5
9.0	0.561	175.6	2.799	20.9	0.057	-5.5	0.413	-121.5	1.699	12.0
9.5	0.545	168.1	2.716	14.0	0.057	-7.7	0.413	-126.7	1.810	11.6
10.0	0.529	160.3	2.633	7.1	0.056	-9.8	0.413	-131.9	1.929	11.2
10.5	0.515	152.4	2.571	0.2	0.056	-12.9	0.419	-137.0	1.998	10.9
11.0	0.502	144.6	2.508	-6.8	0.056	-16.0	0.426	-142.1	2.070	10.6
11.5	0.488	136.7	2.446	-13.7	0.056	-19.0	0.433	-147.1	2.145	10.3
12.0	0.475	147.5	2.384	-20.6	0.056	-22.1	0.439	-152.2	2.223	10.1

**MGF1902B**

**LOW NOISE GaAs FET**

**NOISE PARAMETERS** ( $V_{DS}=3V$ ,  $I_D=10mA$ )

Freq. (GHz)	$\Gamma_{opt}$		$R_n$ ( $\Omega$ )	NF min. (dB)
	Mang.	Angle (deg.)		
1	0.747	5.6	25.7	0.77
2	0.683	22.4	26.3	0.82
3	0.638	42.2	26.9	0.89
4	0.595	63.5	27.5	0.96
5	0.562	80.2	28.1	1.19
6	0.530	97.9	28.7	1.41
7	0.503	115.2	28.3	1.63
8	0.475	134.5	30.0	1.85
9	0.450	150.7	26.3	2.08
10	0.430	167.2	22.6	2.30
11	0.408	-174.5	18.8	2.53
12	0.385	-155.3	15.0	2.76

**$G_{LP}$  and  $P_{1dB}$**  ( $T_a=25^\circ C$ ,  $V_D=3V$ )

	f = 4GHz		f = 12GHz	
	$I_D=10mA$	$I_D=30mA$	$I_D=10mA$	$I_D=30mA$
$G_{LP}$ (dB)	15.5	16.8	9.6	10.5
$P_{1dB}$ (dBm)	12.6	14.5	10.5	12.7