



Hybrid Power Module

Integrated Power Stage for 2.0 hp Motor Drives

This module integrates a 3-phase input rectifier bridge, 3-phase output inverter and brake transistor/diode in a single convenient package. The output inverter utilizes advanced insulated gate bipolar transistors (IGBT) matched with free-wheeling diodes to give optimal dynamic performance. It has been configured for use as a three-phase motor drive module or for many other power switching applications. The top connector pins have been designed for easy interfacing to the user's control board.

- Short Circuit Rated 10 μ s @ 25°C
- Pin-to-Baseplate Isolation Exceeds 2500 Vac (rms)
- Convenient Package Outline
- UL  Recognized and Designed to Meet VDE 
- Access to Positive and Negative DC Bus

MHPM7B20A60A

Motorola Preferred Device

**20 AMP, 600 VOLT
HYBRID POWER MODULE**

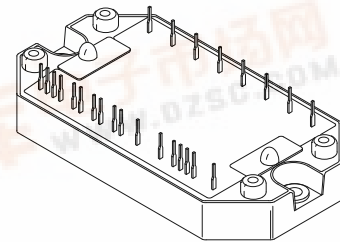

PLASTIC PACKAGE
CASE 440-01, Style 1

MAXIMUM DEVICE RATINGS (T_J = 25°C unless otherwise noted)

Rating	Symbol	Value	Unit
INPUT RECTIFIER BRIDGE			
Repetitive Peak Reverse Voltage	V _R RM	600	V
Average Output Rectified Current (1)	I _O	20	A
Peak Non-repetitive Surge Current	I _{FSM}	240	A
OUTPUT INVERTER			
IGBT Reverse Voltage	V _{CES}	600	V
Gate-Emitter Voltage	V _{GES}	± 20	V
Continuous IGBT Collector Current	I _C	20	A
Peak IGBT Collector Current – (PW = 1.0 ms) (2)	I _{C(pk)}	40	A
Continuous Free-Wheeling Diode Current	I _F	20	A
Peak Free-Wheeling Diode Current – (PW = 1.0 ms) (2)	I _{F(pk)}	40	A
IGBT Power Dissipation	P _D	78	W
Free-Wheeling Diode Power Dissipation	P _D	39	W
IGBT Junction Temperature Range	T _J	– 40 to +125	°C
Free-Wheeling Diode Junction Temperature Range	T _J	– 40 to +125	°C

(1) 1 cycle = 50 or 60 Hz

(2) 1 ms = 1.0% duty cycle

Preferred devices are Motorola recommended choices for future use and best overall value.

MAXIMUM DEVICE RATINGS (continued) ($T_J = 25^\circ\text{C}$ unless otherwise noted)

Rating	Symbol	Value	Unit
BRAKE CIRCUIT			
IGBT Reverse Voltage	V_{CES}	600	V
Gate-Emitter Voltage	V_{GES}	± 20	V
Continuous IGBT Collector Current	I_C	20	A
Peak IGBT Collector Current (PW = 1.0 ms) (2)	$I_{C(pk)}$	40	A
IGBT Power Dissipation	PD	78	W
Diode Reverse Voltage	V_{RRM}	600	V
Continuous Output Diode Current	I_F	20	A
Peak Output Diode Current (PW = 1.0 ms) (2)	$I_{F(pk)}$	40	A
TOTAL MODULE			
Isolation Voltage – (47–63 Hz, 1.0 Minute Duration)	V_{ISO}	2500	VAC
Ambient Operating Temperature Range	T_A	- 40 to + 85	$^\circ\text{C}$
Operating Case Temperature Range	T_C	- 40 to + 90	$^\circ\text{C}$
Storage Temperature Range	T_{stg}	- 40 to +150	$^\circ\text{C}$
Mounting Torque	–	6.0	lb-in

ELECTRICAL CHARACTERISTICS ($T_J = 25^\circ\text{C}$ unless otherwise noted)

Characteristic	Symbol	Min	Typ	Max	Unit
INPUT RECTIFIER BRIDGE					
Reverse Leakage Current ($V_{RRM} = 600\text{ V}$)	I_R	–	10	50	μA
Forward Voltage ($I_F = 20\text{ A}$)	V_F	–	1.1	1.5	V
Thermal Resistance (Each Die)	$R_{\theta JC}$	–	–	2.9	$^\circ\text{C/W}$
OUTPUT INVERTER					
Gate-Emitter Leakage Current ($V_{CE} = 0\text{ V}$, $V_{GE} = \pm 20\text{ V}$)	I_{GES}	–	–	± 20	μA
Collector-Emitter Leakage Current ($V_{CE} = 600\text{ V}$, $V_{GE} = 0\text{ V}$) $T_J = 25^\circ\text{C}$ $T_J = 125^\circ\text{C}$	I_{CES}	– –	– –	200 1.0	μA mA
Gate-Emitter Threshold Voltage ($V_{CE} = V_{GE}$, $I_C = 1.0\text{ mA}$)	$V_{GE(th)}$	4.0	6.0	8.0	V
Collector-Emitter Breakdown Voltage ($I_C = 10\text{ mA}$, $V_{GE} = 0$)	$V_{(BR)CES}$	600	700	–	V
Collector-Emitter Saturation Voltage ($I_C = 20\text{ A}$, $V_{GE} = 15\text{ V}$)	$V_{CE(SAT)}$	–	2.5	3.5	V
Input Capacitance ($V_{GE} = 0\text{ V}$, $V_{CE} = 10\text{ V}$, $f = 1.0\text{ MHz}$)	C_{ies}	–	4400	–	pF
Input Gate Charge ($V_{CE} = 300\text{ V}$, $I_C = 20\text{ A}$, $V_{GE} = 15\text{ V}$)	Q_T	–	145	–	nC
Fall Time – Inductive Load ($V_{CE} = 300\text{ V}$, $I_C = 20\text{ A}$, $V_{GE} = 15\text{ V}$, $R_G = 150\ \Omega$)	t_{fi}	–	250	500	ns
Turn-On Energy ($V_{CE} = 300\text{ V}$, $I_C = 20\text{ A}$, $V_{GE} = 15\text{ V}$, $R_G = 150\ \Omega$)	$E_{(on)}$	–	–	2.5	mJ
Turn-Off Energy ($V_{CE} = 300\text{ V}$, $I_C = 20\text{ A}$, $V_{GE} = 15\text{ V}$, $R_G = 150\ \Omega$)	$E_{(off)}$	–	–	2.5	mJ
Diode Forward Voltage ($I_F = 20\text{ A}$, $V_{GE} = 0\text{ V}$)	V_F	–	1.3	2.0	V
Diode Reverse Recovery Time ($I_F = 20\text{ A}$, $V = 300\text{ V}$, $di/dt = 50\text{ A}/\mu\text{s}$)	t_{rr}	–	170	200	ns
Diode Stored Charge ($I_F = 20\text{ A}$, $V = 300\text{ V}$, $di/dt = 50\text{ A}/\mu\text{s}$)	Q_{rr}	–	450	600	nC
Thermal Resistance – IGBT (Each Die)	$R_{\theta JC}$	–	–	1.5	$^\circ\text{C/W}$
Thermal Resistance – Free-Wheeling Diode (Each Die)	$R_{\theta JC}$	–	–	2.9	$^\circ\text{C/W}$

(2) 1.0 ms = 1.0% duty cycle

ELECTRICAL CHARACTERISTICS (continued) ($T_J = 25^\circ\text{C}$ unless otherwise noted)

Characteristic	Symbol	Min	Typ	Max	Unit
BRAKE CIRCUIT					
Gate-Emitter Leakage Current ($V_{CE} = 0\text{ V}$, $V_{GE} = \pm 20\text{ V}$)	I_{GES}	–	–	± 20	μA
Collector-Emitter Leakage Current ($V_{CE} = 600\text{ V}$, $V_{GE} = 0\text{ V}$)	I_{CES}	–	–	100	μA
$T_J = 25^\circ\text{C}$		–	–	2.0	mA
$T_J = 125^\circ\text{C}$		–	–	–	–
Gate-Emitter Threshold Voltage ($V_{CE} = V_{GE}$, $I_C = 1.0\text{ mA}$)	$V_{GE(th)}$	4.0	6.0	8.0	V
Collector-Emitter Breakdown Voltage ($I_C = 10\text{ mA}$, $V_{GE} = 0$)	$V_{(BR)CES}$	600	700	–	V
Collector-Emitter Saturation Voltage ($V_{GE} = 15\text{ V}$, $I_C = 20\text{ A}$)	$V_{CE(SAT)}$	–	2.5	3.5	V
Input Capacitance ($V_{GE} = 0\text{ V}$, $V_{CE} = 25\text{ V}$, $f = 1.0\text{ MHz}$)	C_{ies}	–	4400	–	pF
Input Gate Charge ($V_{CE} = 300\text{ V}$, $I_C = 20\text{ A}$, $V_{GE} = 15\text{ V}$)	Q_T	–	145	–	nC
Fall Time – Inductive Load ($V_{CE} = 300\text{ V}$, $I_C = 20\text{ A}$, $V_{GE} = 15\text{ V}$, $R_G = 150\ \Omega$)	t_{fi}	–	250	500	ns
Turn-On Energy ($V_{CE} = 300\text{ V}$, $I_C = 20\text{ A}$, $V_{GE} = 15\text{ V}$, $R_G = 150\ \Omega$)	$E_{(on)}$	–	–	2.5	mJ
Turn-Off Energy ($V_{CE} = 300\text{ V}$, $I_C = 20\text{ A}$, $V_{GE} = 15\text{ V}$, $R_G = 150\ \Omega$)	$E_{(off)}$	–	–	2.5	mJ
Diode Forward Voltage ($I_F = 20\text{ A}$)	V_F	–	1.3	2.0	V
Diode Reverse Leakage Current	I_R	–	–	50	μA
Thermal Resistance – IGBT	$R_{\theta JC}$	–	–	1.5	$^\circ\text{C/W}$
Thermal Resistance – Diode	$R_{\theta JC}$	–	–	2.9	$^\circ\text{C/W}$

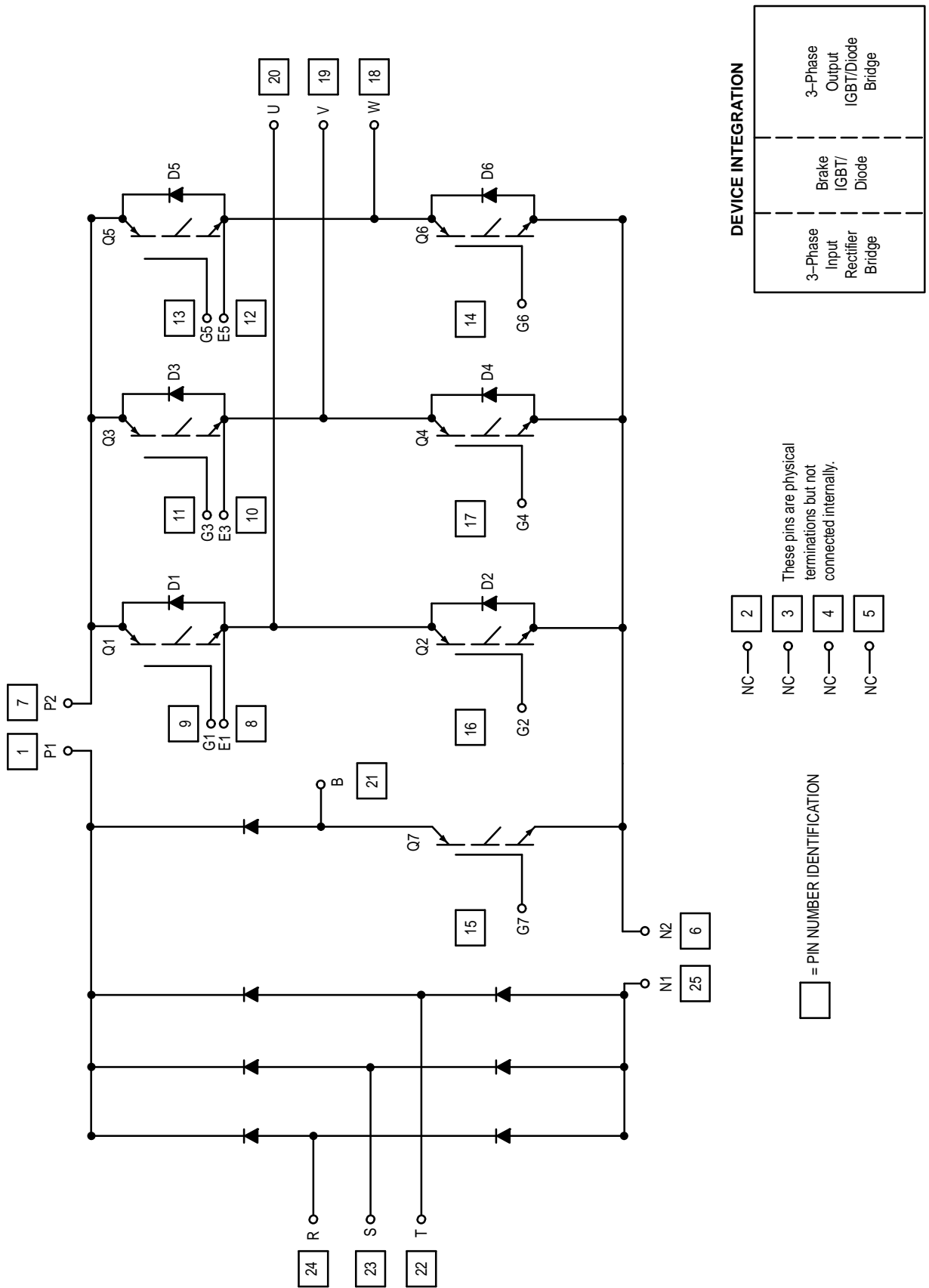

DEVICE INTEGRATION

3-Phase Input Rectifier Bridge	Brake IGBT/ Diode	3-Phase Output IGBT/Diode Bridge
---	-------------------------	---

- NC — 2
 - NC — 3
 - NC — 4
 - NC — 5
- These pins are physical terminations but not connected internally.

□ = PIN NUMBER IDENTIFICATION

Figure 1. Integrated Power Stage Schematic

Typical Characteristics

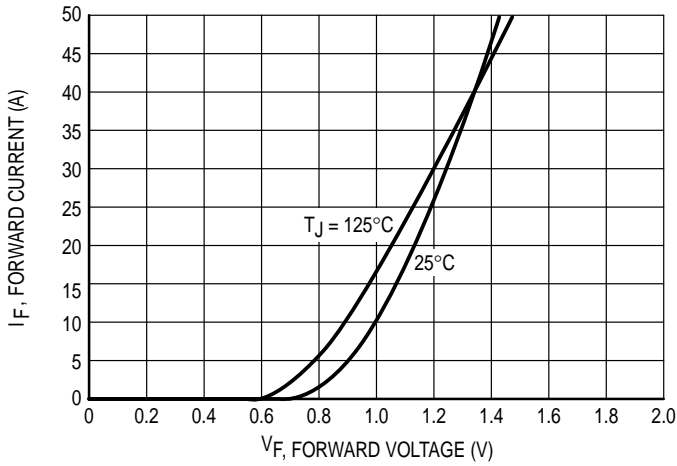

Figure 2. Input Bridge Forward Current I_F versus Forward Voltage V_F

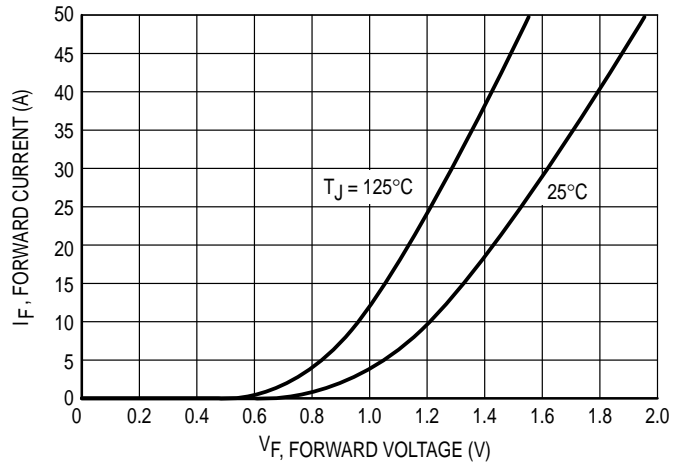

Figure 3. Output Inverter Forward Current I_F versus Forward Voltage V_F

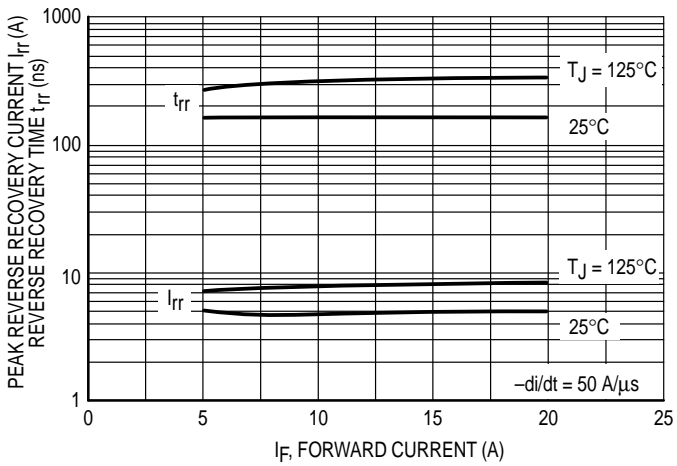

Figure 4. Output Inverter Reverse Recovery t_{rr} , I_{rr} versus Forward Current I_F

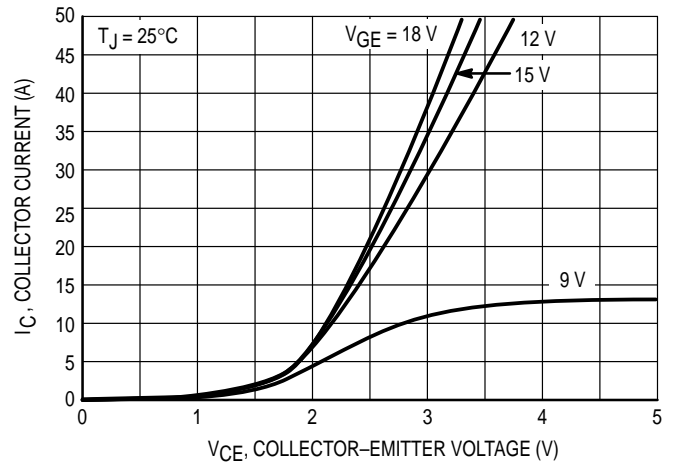

Figure 5. Output Inverter Collector Current I_C versus Collector-Emitter Voltage V_{CE}

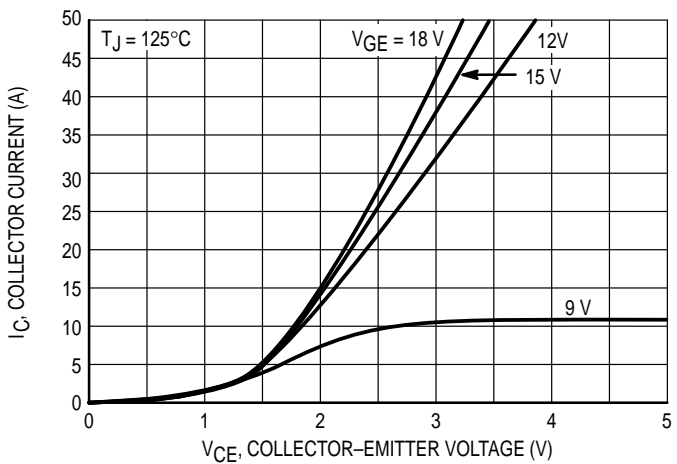

Figure 6. Output Inverter Collector Current I_C versus Collector-Emitter Voltage V_{CE}

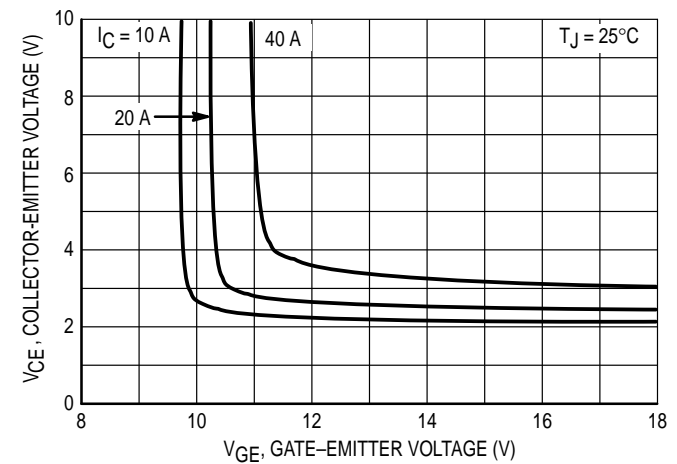

Figure 7. Inverter Collector-Emitter Voltage V_{CE} versus Gate-Emitter Voltage V_{GE}

Typical Characteristics

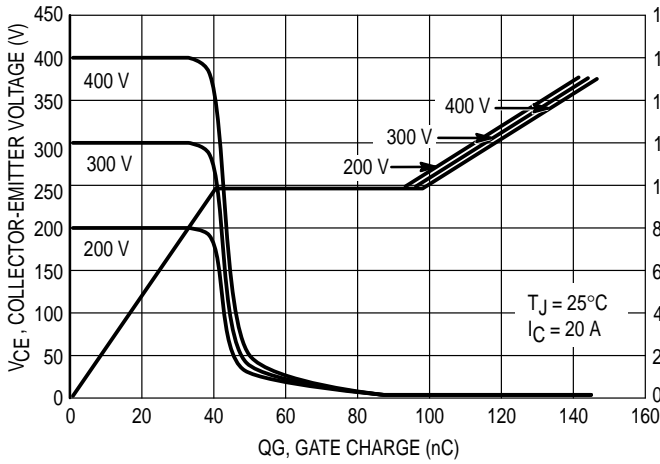

Figure 8. Gate-to-Emitter Voltage versus Gate Charge

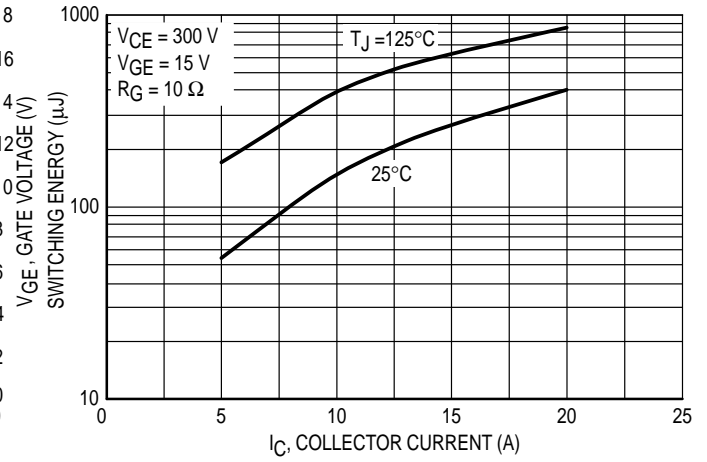

Figure 9. Inverter Switching Energy $E_{(off)}$ versus Collector Current I_C

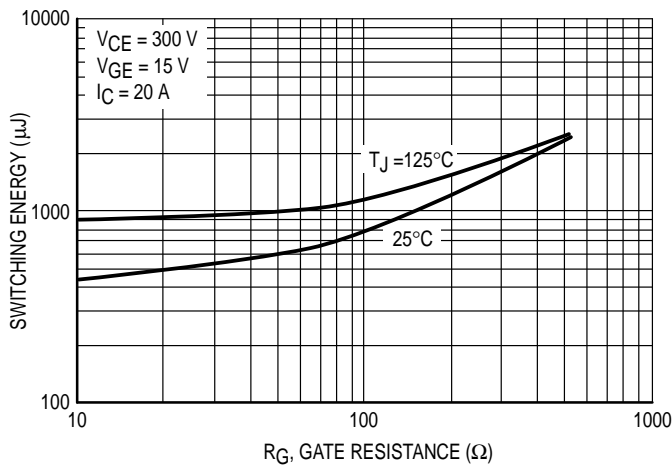

Figure 10. Inverter Switching Energy $E_{(off)}$ versus Gate Resistance R_G

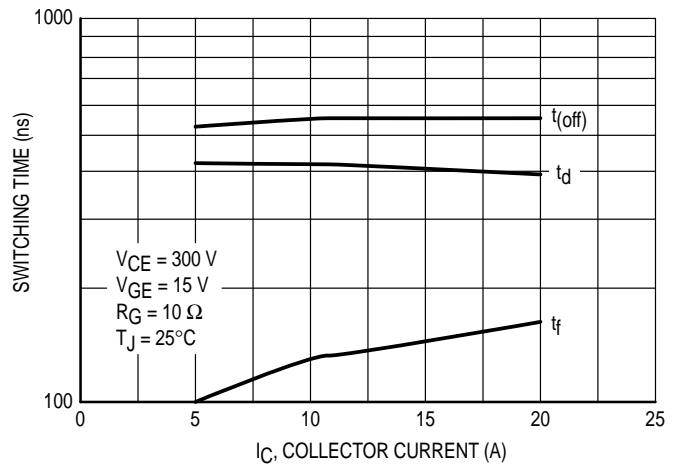

Figure 11. Inverter Switching Time t_d , t_f , $t_{(off)}$ versus Collector Current I_C

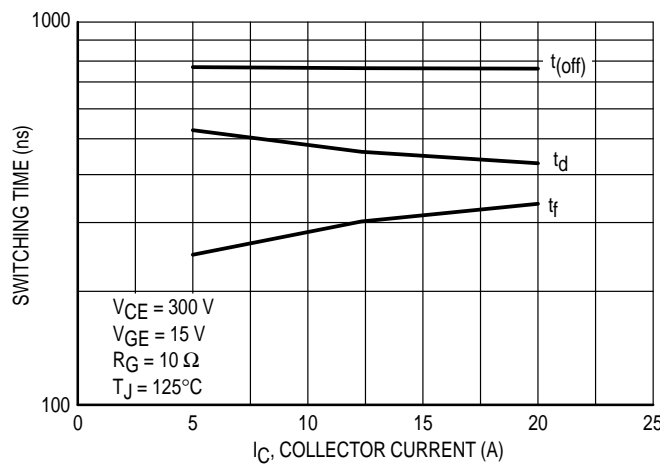

Figure 12. Inverter Switching Time t_d , t_f , $t_{(off)}$ versus Collector Current I_C

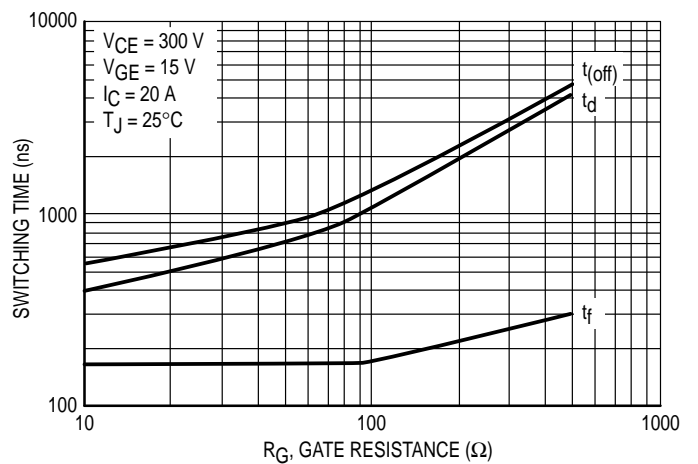

Figure 13. Inverter Switching Time t_d , t_f , $t_{(off)}$ versus Gate Resistance R_G

Typical Characteristics

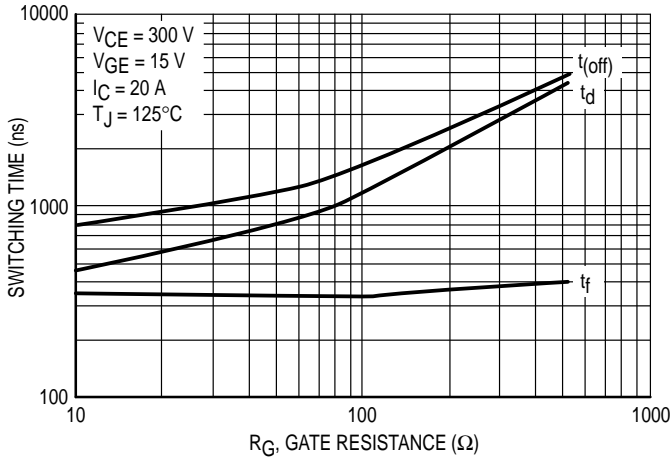

Figure 14. Inverter Switching Time t_d , t_r , $t_{(off)}$ versus Gate Resistance R_G

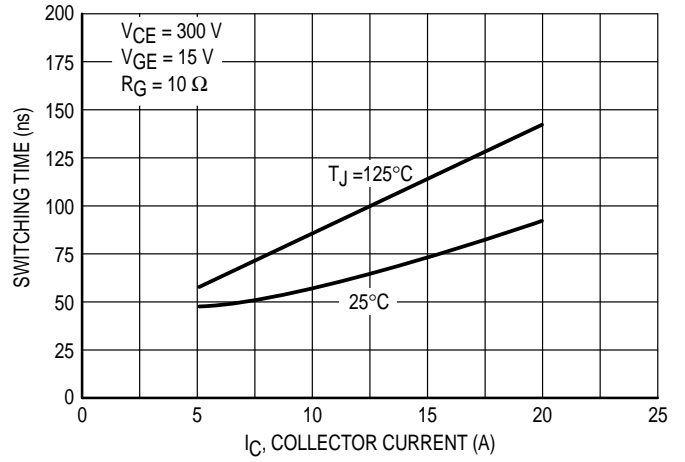

Figure 15. Inverter Switching Time t_r versus Collector Current I_C

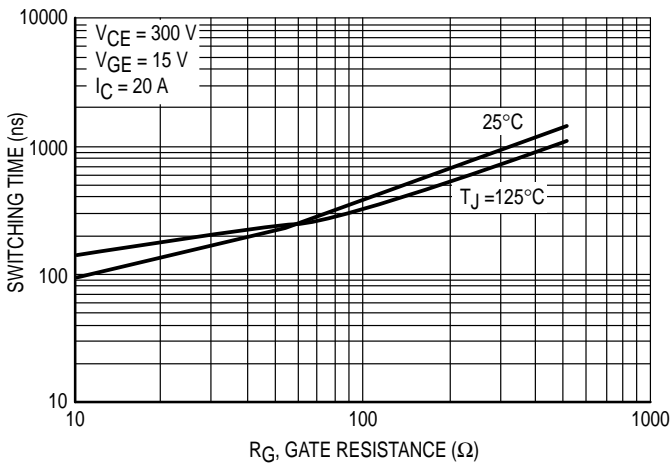

Figure 16. Inverter Switching Time t_r versus Gate Resistance R_G

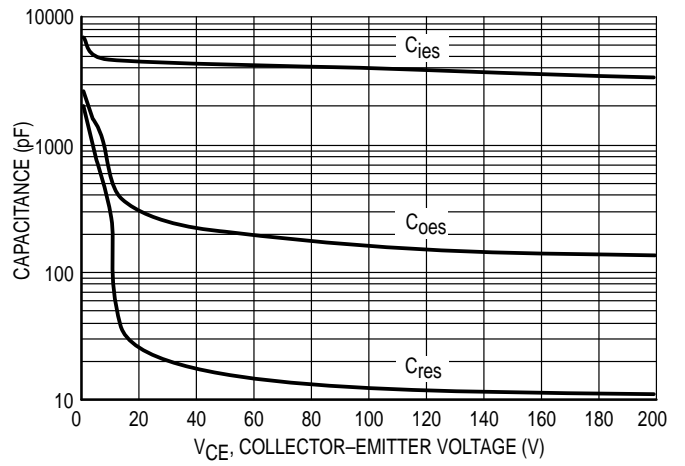

Figure 17. Output Inverter Capacitance versus Collector Voltage V_{CE}

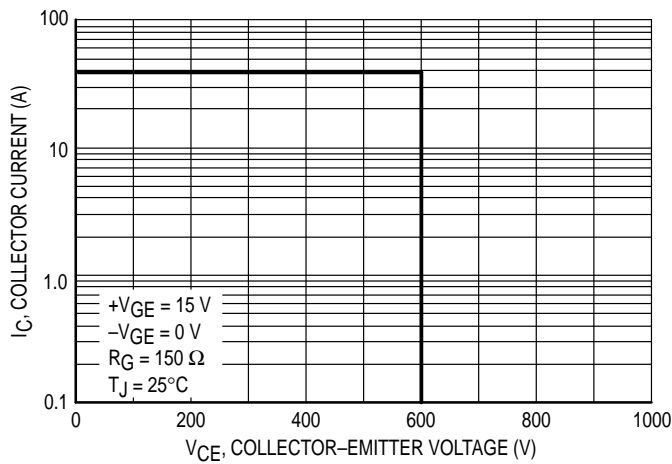

Figure 18. Output Inverter Reversed Biased Safe Operating Area

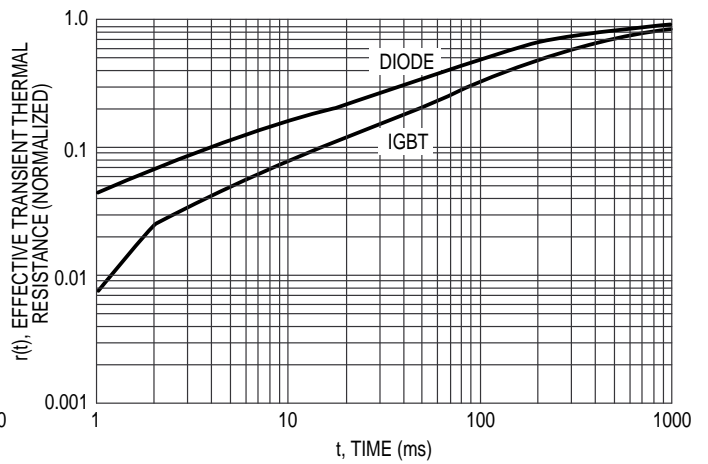
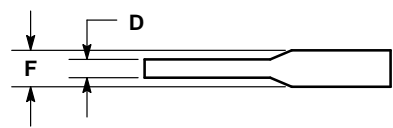
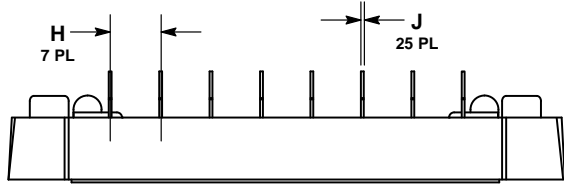
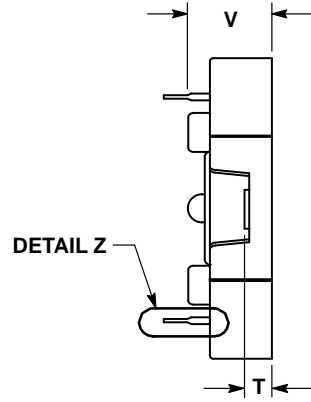
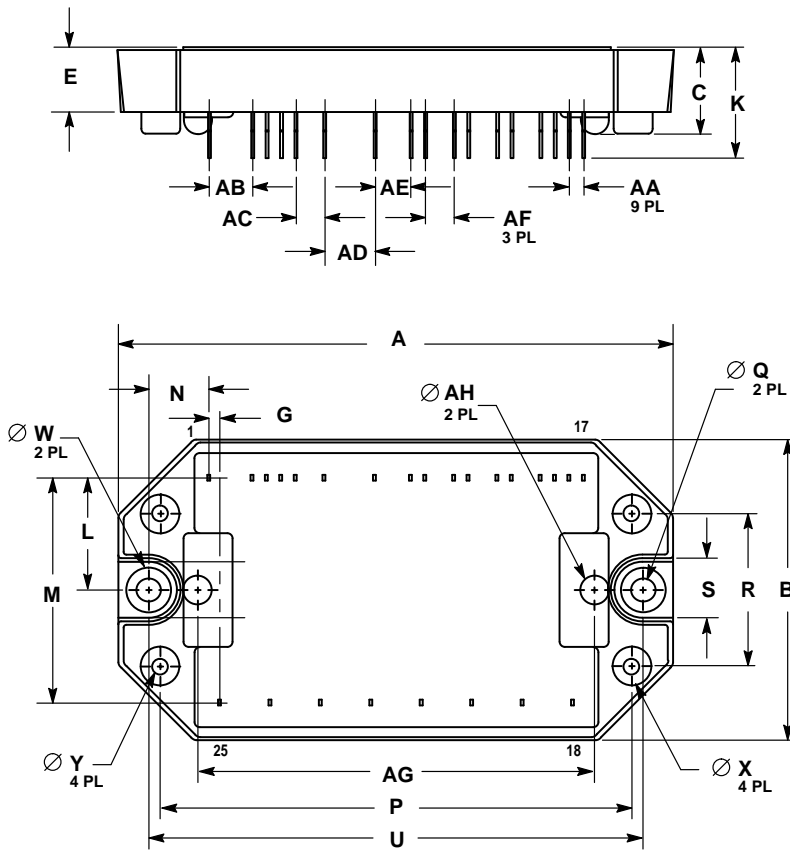

Figure 19. Transient Thermal Resistance

PACKAGE DIMENSIONS



- NOTES:
1. DIMENSIONING AND TOLERANCING PER ANSI Y14.5M, 1982.
 2. CONTROLLING DIMENSION: MILLIMETER.
 3. LEAD LOCATION DIMENSIONS (ie: M, B, AA...) ARE TO THE CENTER OF THE LEAD.

DIM	MILLIMETERS		INCHES	
	MIN	MAX	MIN	MAX
A	97.54	98.55	3.840	3.880
B	52.45	53.47	2.065	2.105
C	14.60	15.88	0.575	0.625
D	0.43	0.84	0.017	0.033
E	10.80	12.06	0.425	0.475
F	0.94	1.35	0.037	0.053
G	1.60	2.21	0.063	0.087
H	8.58	9.19	0.338	0.362
J	0.30	0.71	0.012	0.028
K	18.80	20.57	0.74	0.81
L	19.30	20.32	0.760	0.800
M	38.99	40.26	1.535	1.585
N	9.78	11.05	0.385	0.435
P	82.55	83.57	3.250	3.290
Q	4.01	4.62	0.158	0.182
R	26.42	27.43	1.040	1.080
S	12.06	12.95	0.475	0.515
T	4.32	5.33	0.170	0.210
U	86.36	87.38	3.400	3.440
V	14.22	15.24	0.560	0.600
W	7.62	8.13	0.300	0.320
X	6.55	7.16	0.258	0.282
Y	2.49	3.10	0.098	0.122
AA	2.24	2.84	0.088	0.112
AB	7.32	7.92	0.288	0.312
AC	4.78	5.38	0.188	0.212
AD	8.58	9.19	0.338	0.362
AE	6.05	6.65	0.238	0.262
AF	4.78	5.38	0.188	0.212
AG	69.34	70.36	2.730	2.770
AH	—	5.08	—	0.200

- STYLE 1:
- | | | | | |
|-----------|-----------|------------|------------|-----------|
| PIN 1. P1 | PIN 6. N2 | PIN 11. G3 | PIN 16. G2 | PIN 21. B |
| 2. T- | 7. P2 | 12. K5 | 17. G4 | 22. T |
| 3. T+ | 8. K1 | 13. G5 | 18. W | 23. S |
| 4. I+ | 9. G1 | 14. G6 | 19. V | 24. R |
| 5. I- | 10. K3 | 15. G7 | 20. U | 25. N1 |

CASE 440-01
ISSUE O

Motorola reserves the right to make changes without further notice to any products herein. Motorola makes no warranty, representation or guarantee regarding the suitability of its products for any particular purpose, nor does Motorola assume any liability arising out of the application or use of any product or circuit, and specifically disclaims any and all liability, including without limitation consequential or incidental damages. "Typical" parameters can and do vary in different applications. All operating parameters, including "Typicals" must be validated for each customer application by customer's technical experts. Motorola does not convey any license under its patent rights nor the rights of others. Motorola products are not designed, intended, or authorized for use as components in systems intended for surgical implant into the body, or other applications intended to support or sustain life, or for any other application in which the failure of the Motorola product could create a situation where personal injury or death may occur. Should Buyer purchase or use Motorola products for any such unintended or unauthorized application, Buyer shall indemnify and hold Motorola and its officers, employees, subsidiaries, affiliates, and distributors harmless against all claims, costs, damages, and expenses, and reasonable attorney fees arising out of, directly or indirectly, any claim of personal injury or death associated with such unintended or unauthorized use, even if such claim alleges that Motorola was negligent regarding the design or manufacture of the part. Motorola and  are registered trademarks of Motorola, Inc. Motorola, Inc. is an Equal Opportunity/Affirmative Action Employer.

How to reach us:

USA/EUROPE: Motorola Literature Distribution;
P.O. Box 20912; Phoenix, Arizona 85036. 1-800-441-2447

MFAX: RMFAX0@email.sps.mot.com -TOUCHTONE (602) 244-6609
INTERNET: <http://Design-NET.com>

JAPAN: Nippon Motorola Ltd.; Tatsumi-SPD-JLDC, Toshikatsu Otsuki,
6F Seibu-Butsuryu-Center, 3-14-2 Tatsumi Koto-Ku, Tokyo 135, Japan. 03-3521-8315

HONG KONG: Motorola Semiconductors H.K. Ltd.; 8B Tai Ping Industrial Park,
51 Tinq Kok Road, Tai Po, N.T., Hong Kong. 852-26629298

