

# SEMIX 252GB126HD

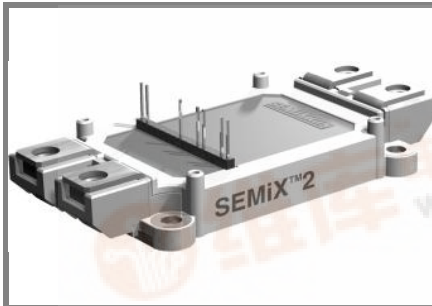

SEMIX<sup>®</sup> 2

## Trench IGBT Modules

### SEMIX 252GB126HD

Preliminary Data

#### Features

- Homogeneous Si
- Trench = Trenchgate technology
- $V_{CE(sat)}$  with positive temperature coefficient
- High short circuit capability

#### Typical Applications

- AC inverter drives
- UPS
- Electronic Welding

Absolute Maximum Ratings		$T_{case} = 25^{\circ}C$ , unless otherwise specified	
Symbol	Conditions	Values	Units
<b>IGBT</b>			
$V_{CES}$		1200	V
$I_C$	$T_c = 25 (80)^{\circ}C$	240 (170)	A
$I_{CRM}$	$t_p = 1 ms$	300	A
$V_{GES}$		$\pm 20$	V
$T_{vj}, (T_{stg})$	$T_{OPERATION} \leq T_{stg}$	- 40 ... + 150 (125)	$^{\circ}C$
$V_{isol}$	AC, 1 min.	4000	V
<b>Inverse diode</b>			
$I_F$	$T_c = 25 (80)^{\circ}C$	200 (140)	A
$I_{FRM}$	$t_p = 1 ms$	300	A
$I_{FSM}$	$t_p = 10 ms; sin.; T_j = 25^{\circ}C$	1200	A

Characteristics		$T_{case} = 25^{\circ}C$ , unless otherwise specified			
Symbol	Conditions	min.	typ.	max.	Units
<b>IGBT</b>					
$V_{GE(th)}$	$V_{GE} = V_{CE}, I_C = 6 mA$	5	5,8	6,5	V
$I_{CES}$	$V_{GE} = 0, V_{CE} = V_{CES}, T_j = 25 (125)^{\circ}C$			1	mA
$V_{CE(TO)}$	$T_j = 25 (125)^{\circ}C$		1 (0,9)	1,2 (1,1)	V
$r_{CE}$	$V_{GE} = 15 V, T_j = 25 (125)^{\circ}C$		4,7 (7,3)	6,3 (9)	m $\Omega$
$V_{CE(sat)}$	$I_{Cnom} = 150 A, V_{GE} = 15 V, T_j = 25 (125)^{\circ}C, \text{chip level}$		1,7 (2)	2,15 (2,45)	V
$C_{ies}$	under following conditions		10,7		nF
$C_{oes}$	$V_{GE} = 0, V_{CE} = 25 V, f = 1 MHz$		0,6		nF
$C_{res}$			0,5		nF
$L_{CE}$			18		nH
$R_{CC+EE}$	terminal-chip, $T_c = 25 (125)^{\circ}C$				m $\Omega$
$t_{d(on)}/t_r$	$V_{CC} = 600 V, I_{Cnom} = 150 A$		300 / 45		ns
$t_{d(off)}/t_f$	$V_{GE} = \pm 15 V$		570 / 110		ns
$E_{on} (E_{off})$	$R_{Gon} = R_{Goff} = 3 \Omega, T_j = 125^{\circ}C$		20 (21)		mJ
<b>Inverse diode</b>					
$V_F = V_{EC}$	$I_{Fnom} = 150 A; V_{GE} = 0 V; T_j = 25 (125)^{\circ}C, \text{chip level}$		1,6 (1,6)	1,8 (1,8)	V
$V_{(TO)}$	$T_j = 25 (125)^{\circ}C$		1 (0,8)	1,1 (0,9)	V
$r_T$	$T_j = 25 (125)^{\circ}C$		4 (5,3)	4,7 (6)	m $\Omega$
$I_{RRM}$	$I_{Fnom} = 150 A; T_j = 25 (125)^{\circ}C$		(265)		A
$Q_{rr}$	$di/dt = 4600 A/\mu s$		(43)		$\mu C$
$E_{rr}$	$V_{GE} = -15 V$		(18)		mJ
<b>Thermal characteristics</b>					
$R_{th(j-c)}$	per IGBT			0,15	K/W
$R_{th(j-c)D}$	per Inverse Diode			0,3	K/W
$R_{th(j-c)FD}$	per FWD				K/W
$R_{th(c-s)}$	per module		0,045		K/W
<b>Temperature sensor</b>					
$R_{25}$	$T_c = 25^{\circ}C$		5 $\pm$ 5%		k $\Omega$
$B_{25/85}$	$R_2 = R_1 \exp[B(1/T_2 - 1/T_1)]; T[K]; B$		3420		K
<b>Mechanical data</b>					
$M_s/M_t$	to heatsink (M5) / for terminals (M6)	3/2,5		5 / 5	Nm
w			236		g

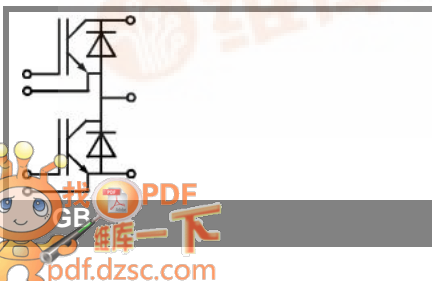

# SEMIX 252GB126HD

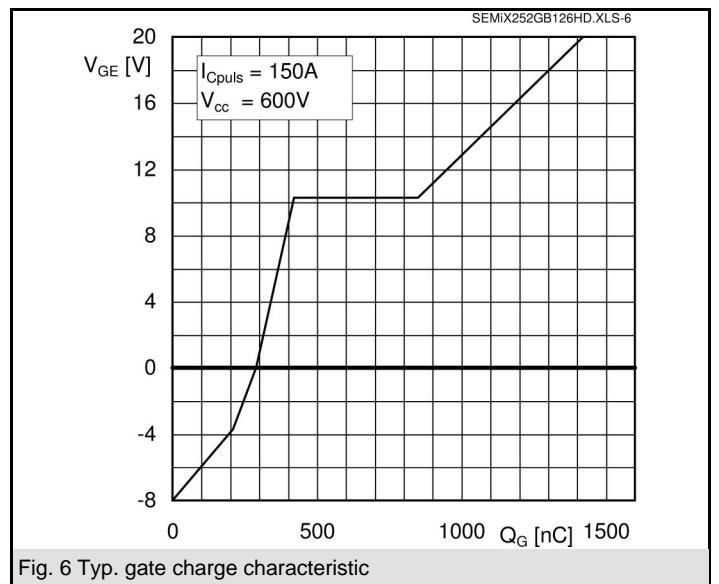
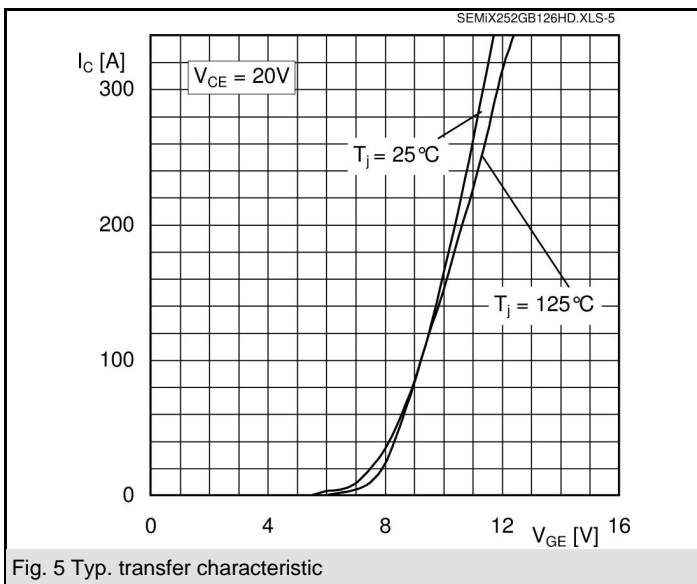
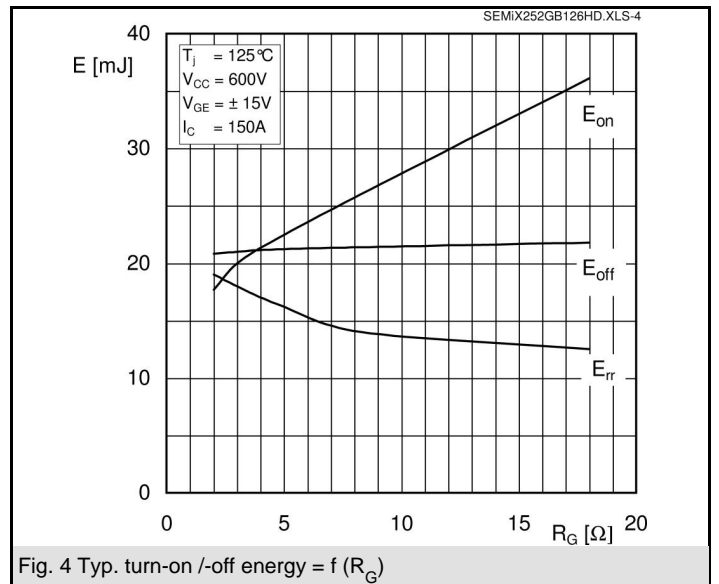
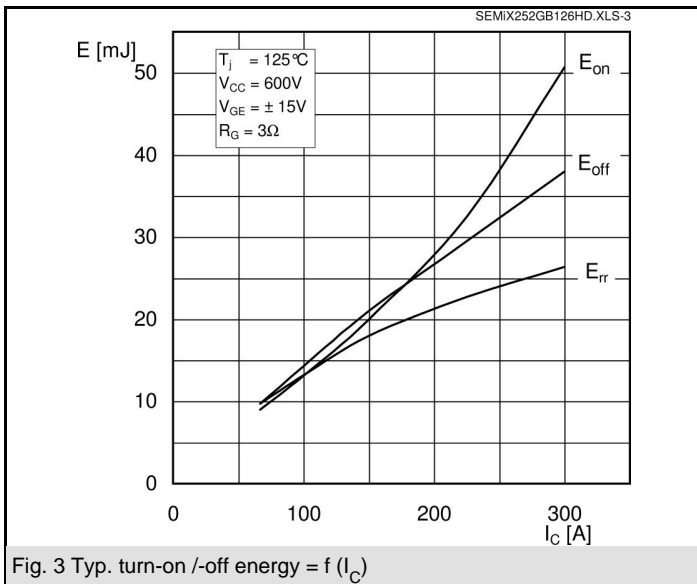
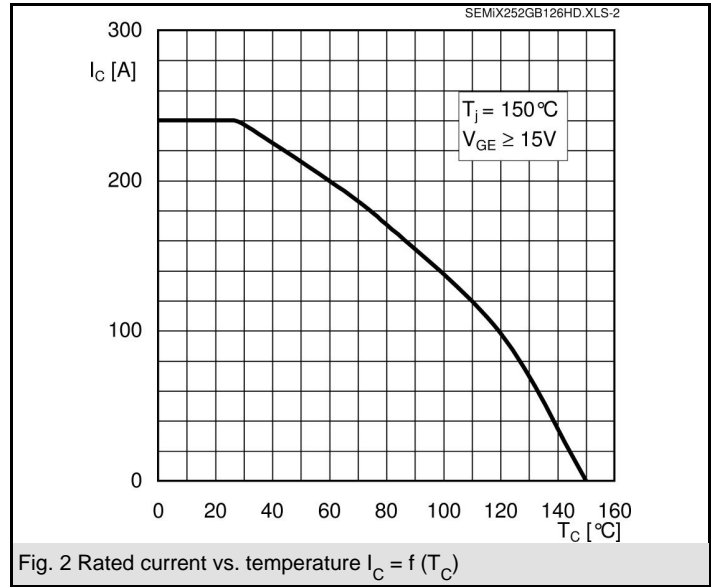
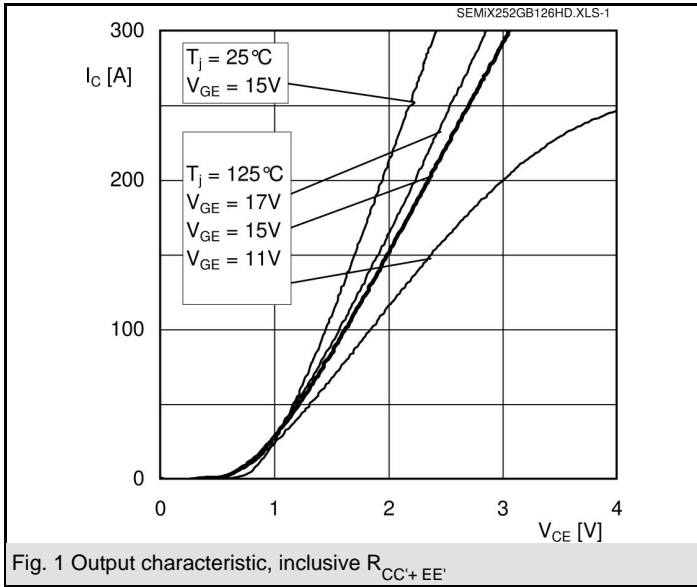

# SEMiX 252GB126HD

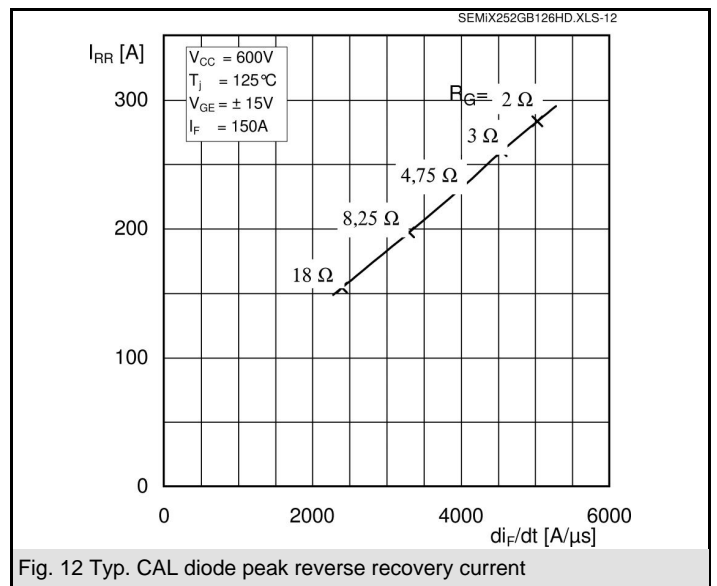
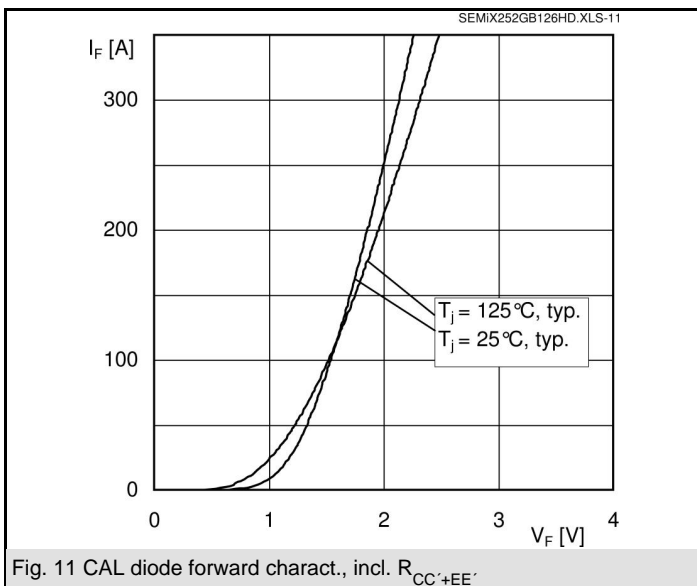
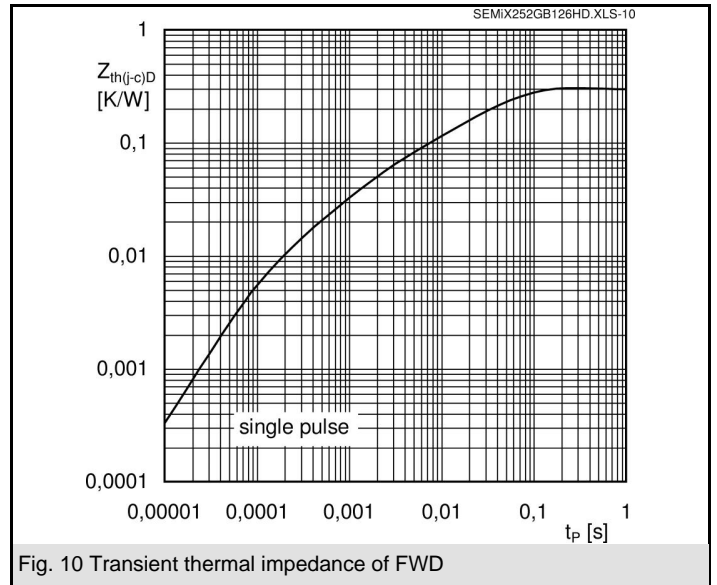
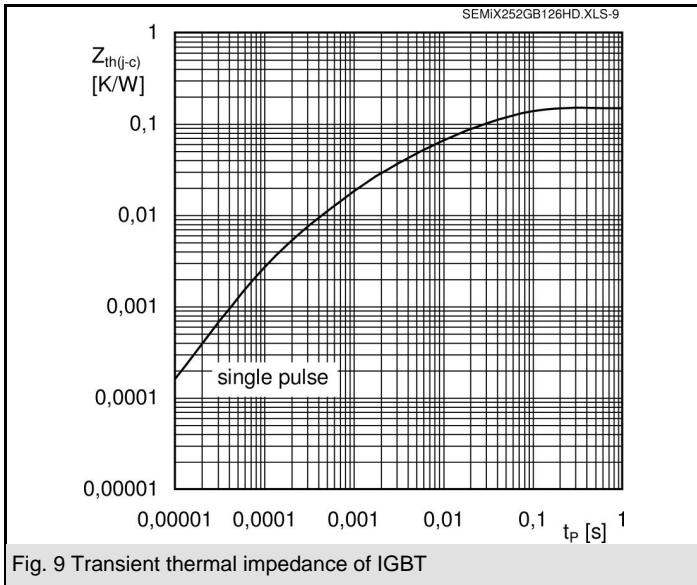
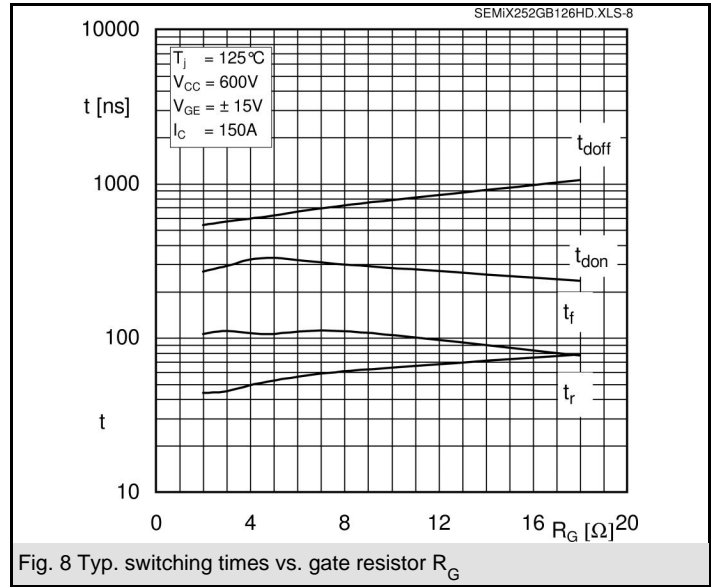
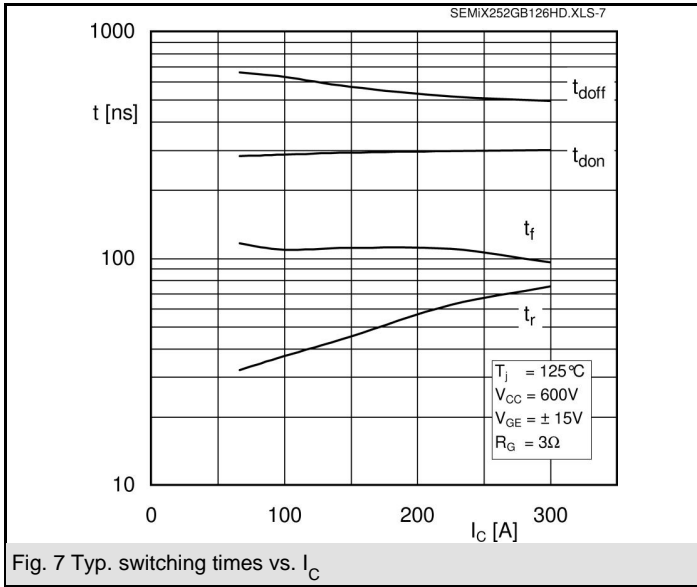

# SEMiX 252GB126HD

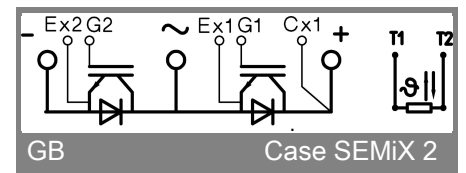
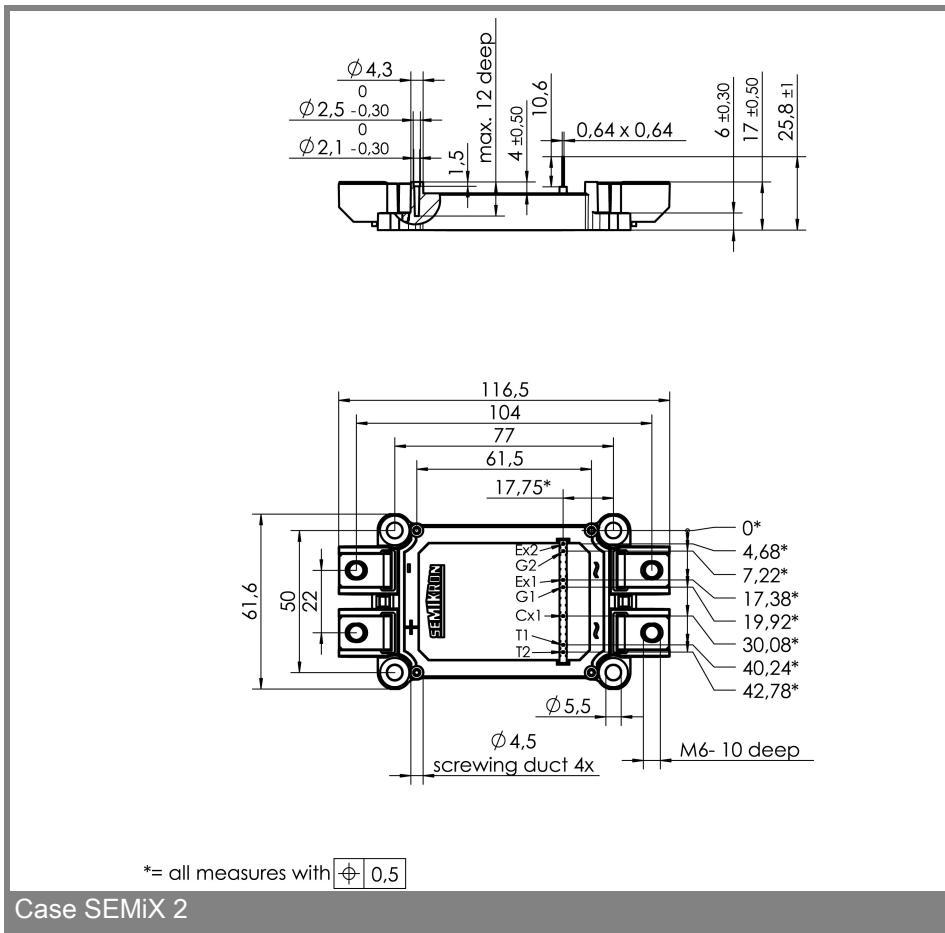
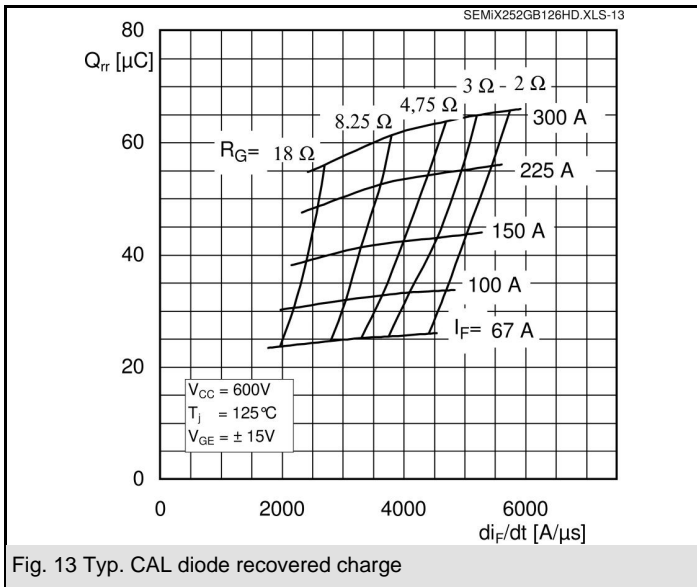

This is an electrostatic discharge sensitive device (ESDS), international standard IEC 60747-1, Chapter IX.

This technical information specifies semiconductor devices but promises no characteristics. No warranty or guarantee expressed or implied is made regarding delivery, performance or suitability.