

# Complementary Power Darlington

## For Isolated Package Applications

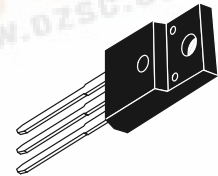
Designed for general-purpose amplifiers and switching applications, where the mounting surface of the device is required to be electrically isolated from the heatsink or chassis.

- Isolated Overmold Package, TO-220 Type
- Electrically Similar to the Popular 2N6388, 2N6668, TIP102 and TIP107
- 100  $V_{CEO(sus)}$
- 10 A Rated Collector Current
- No Isolating Washers Required
- Reduced System Cost
- High DC Current Gain — 1000 (Min) @  $I_C = 5.0 \text{ Adc}$
- High Isolation Voltage (up to 4500 VRMS)
- Case 221D is UL Recognized at 3500 VRMS: File #E69369

**NPN**  
**MJF6388\***  
**PNP**  
**MJF6668\***

\*Motorola Preferred Devices

**COMPLEMENTARY SILICON POWER DARLINGTONS**  
**10 AMPERES**  
**100 VOLTS**  
**40 WATTS**



**CASE 221D-02**  
**UL RECOGNIZED**

### MAXIMUM RATINGS

Rating	Symbol	Value	Unit
Collector-Emitter Voltage	$V_{CEO}$	100	Vdc
Collector-Base Voltage	$V_{CB}$	100	Vdc
Emitter-Base Voltage	$V_{EB}$	5.0	Vdc
RMS Isolation Voltage (1) (for 1 sec, R.H. < 30%, $T_A = 25^\circ\text{C}$ )	$V_{ISOL}$	4500 3500 1500	V
Collector Current — Continuous — Peak(2)	$I_C$	10 15	A dc
Base Current	$I_B$	1.0	A dc
Total Power Dissipation* @ $T_C = 25^\circ\text{C}$ Derate above $25^\circ\text{C}$	$P_D$	40 0.31	Watts W/ $^\circ\text{C}$
Total Power Dissipation @ $T_A = 25^\circ\text{C}$ Derate above $25^\circ\text{C}$	$P_D$	2.0 0.016	Watts W/ $^\circ\text{C}$
Operating and Storage Junction Temperature Range	$T_J, T_{stg}$	-65 to +150	$^\circ\text{C}$

### THERMAL CHARACTERISTICS

Characteristic	Symbol	Max	Unit
Thermal Resistance, Junction to Case*	$R_{\theta JC}$	3.2	$^\circ\text{C/W}$
Thermal Resistance, Junction to Ambient	$R_{\theta JA}$	62.5	$^\circ\text{C/W}$
Lead Temperature for Soldering Purpose	$T_L$	260	$^\circ\text{C}$

(1) Proper strike and creepage distance must be provided.

(2) Pulse Test: Pulse Width = 5.0 ms, Duty Cycle  $\leq 10\%$ .

\* Measurement made with thermocouple contacting the bottom insulated mounting surface of the package (in a location beneath the die), the device mounted on a heatsink, thermal grease applied and a mounting torque of 6 to 8 in•lbs.

Preferred devices are Motorola recommended choices for future use and best overall value.



## MJF6388 MJF6668

### ELECTRICAL CHARACTERISTICS ( $T_C = 25^\circ\text{C}$ unless otherwise noted)

Characteristic	Symbol	Min	Max	Unit
<b>OFF CHARACTERISTICS</b>				
Collector–Emitter Sustaining Voltage (1) ( $I_C = 30\text{ mAdc}$ , $I_B = 0$ )	$V_{CEO(sus)}$	100	—	Vdc
Collector Cutoff Current ( $V_{CE} = 80\text{ Vdc}$ , $I_B = 0$ )	$I_{CEO}$	—	10	$\mu\text{Adc}$
Collector Cutoff Current ( $V_{CE} = 100\text{ Vdc}$ , $V_{EB(off)} = 1.5\text{ Vdc}$ ) ( $V_{CE} = 100\text{ Vdc}$ , $V_{EB(off)} = 1.5\text{ Vdc}$ , $T_C = 125^\circ\text{C}$ )	$I_{CEX}$	— —	10 3.0	$\mu\text{Adc}$ mAdc
Collector Cutoff Current ( $V_{CB} = 100\text{ Vdc}$ , $I_E = 0$ )	$I_{CBO}$	—	10	$\mu\text{Adc}$
Emitter Cutoff Current ( $V_{BE} = 5.0\text{ Vdc}$ , $I_C = 0$ )	$I_{EBO}$	—	2.0	mAdc

### ON CHARACTERISTICS (1)

DC Current Gain ( $I_C = 3.0\text{ Adc}$ , $V_{CE} = 4.0\text{ Vdc}$ ) ( $I_C = 5.0\text{ Adc}$ , $V_{CE} = 3.0\text{ Vdc}$ ) ( $I_C = 8.0\text{ Adc}$ , $V_{CE} = 4.0\text{ Vdc}$ ) ( $I_C = 10\text{ Adc}$ , $V_{CE} = 3.0\text{ Vdc}$ )	$h_{FE}$	3000 1000 200 100	15000 — — —	—
Collector–Emitter Saturation Voltage ( $I_C = 3.0\text{ Adc}$ , $I_B = 6.0\text{ mAdc}$ ) ( $I_C = 5.0\text{ Adc}$ , $I_B = 0.01\text{ Adc}$ ) ( $I_C = 8.0\text{ Adc}$ , $I_B = 80\text{ mAdc}$ ) ( $I_C = 10\text{ Adc}$ , $I_B = 0.1\text{ Adc}$ )	$V_{CE(sat)}$	— — — —	2.0 2.0 2.5 3.0	Vdc
Base–Emitter Saturation Voltage ( $I_C = 5.0\text{ Adc}$ , $I_B = 0.01\text{ Adc}$ ) ( $I_C = 10\text{ Adc}$ , $I_B = 0.1\text{ Adc}$ )	$V_{BE(sat)}$	— —	2.8 4.5	Vdc
Base–Emitter On Voltage ( $I_C = 8.0\text{ Adc}$ , $V_{CE} = 4.0\text{ Vdc}$ )	$V_{BE(on)}$	—	2.5	Vdc

### DYNAMIC CHARACTERISTICS

Small–Signal Current Gain ( $I_C = 1.0\text{ Adc}$ , $V_{CE} = 5.0\text{ Vdc}$ , $f_{test} = 1.0\text{ MHz}$ )	$ h_{fe} $	20	—	—
Output Capacitance ( $V_{CB} = 10\text{ Vdc}$ , $I_E = 0$ , $f = 1.0\text{ MHz}$ )	$C_{ob}$	—	200 300	pF
Insulation Capacitance (Collector–to–External Heatsink)	$C_{c-hs}$	—	3.0 Typ	pF
Small–Signal Current Gain ( $I_C = 1.0\text{ Adc}$ , $V_{CE} = 5.0\text{ Vdc}$ , $f = 1.0\text{ kHz}$ )	$h_{fe}$	1000	—	—

(1) Pulse Test: Pulse Width  $\leq 300\ \mu\text{s}$ , Duty Cycle  $\leq 2.0\%$ .

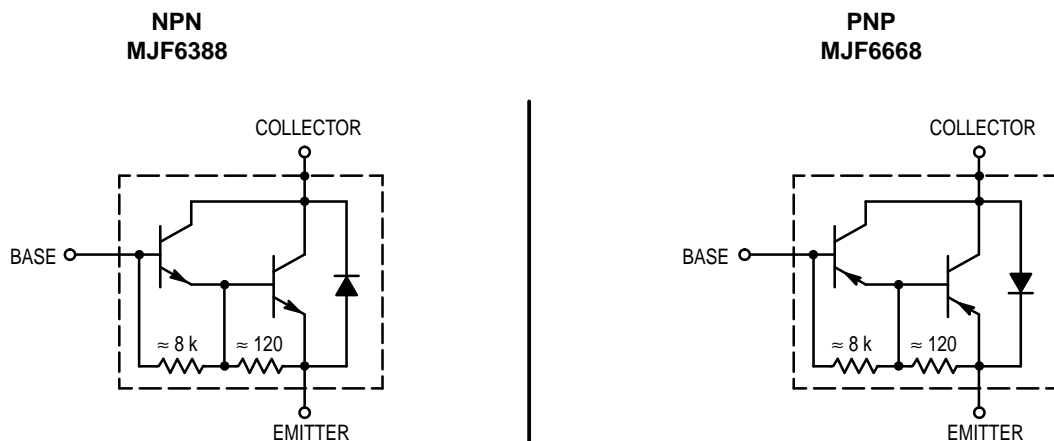
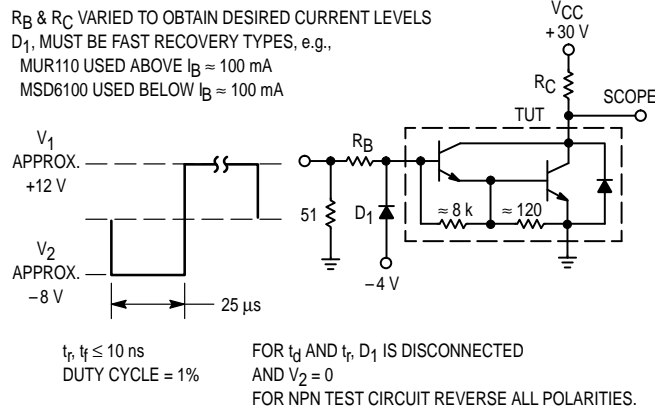
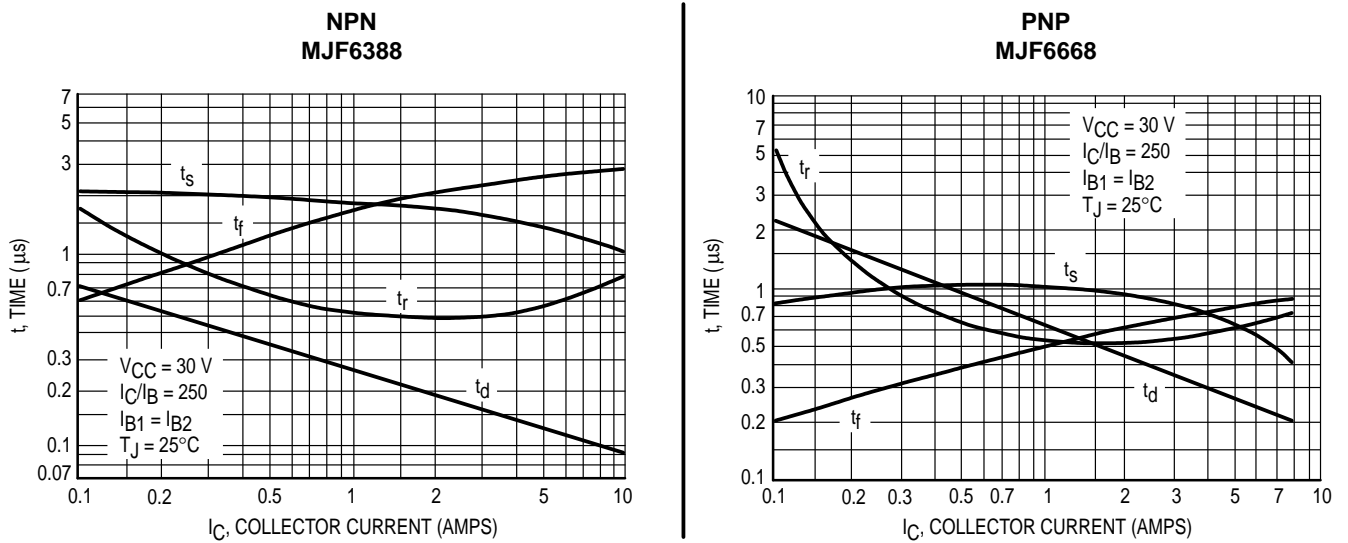


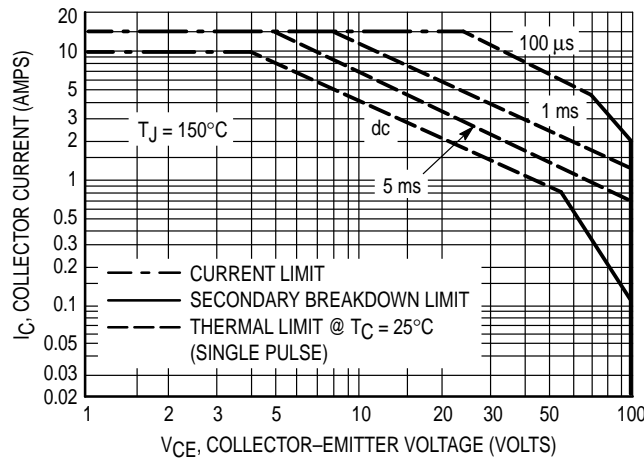
Figure 1. Darlington Schematic



**Figure 2. Switching Times Test Circuit**

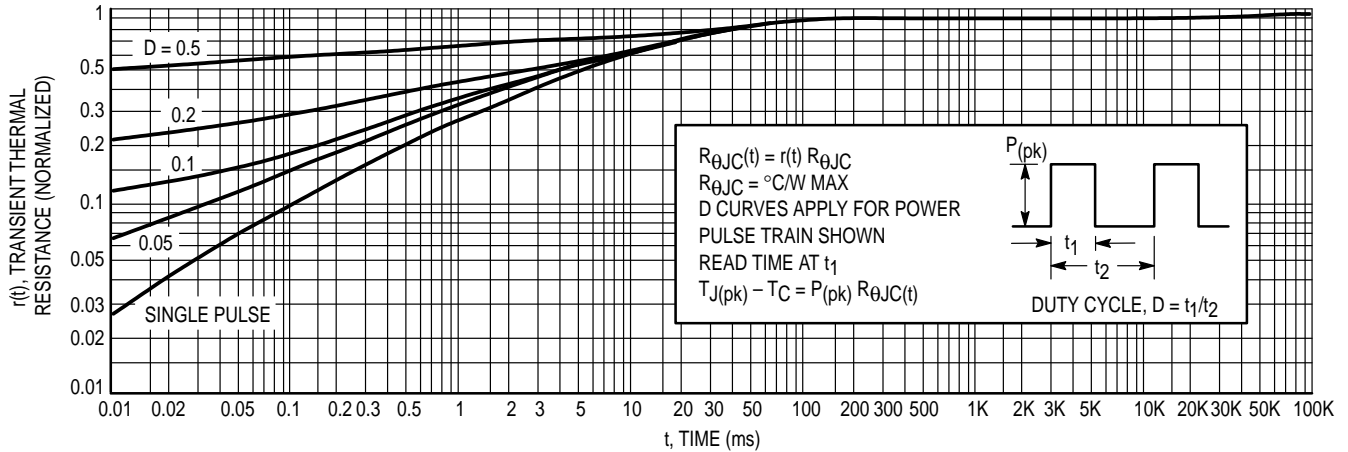


**Figure 3. Typical Switching Times**

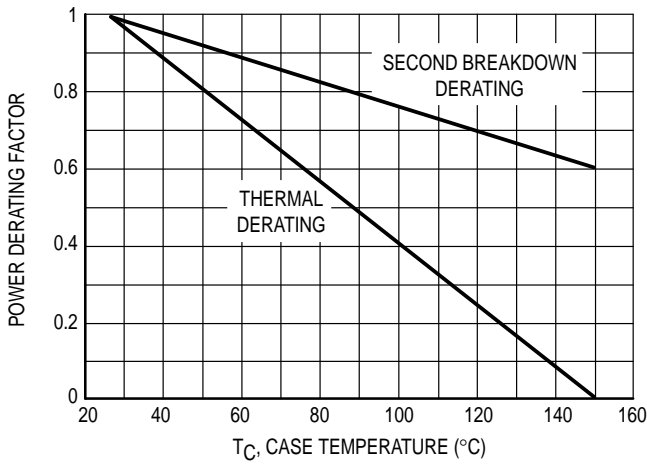


**Figure 4. Maximum Forward Bias Safe Operating Area**

**MJF6388 MJF6668**



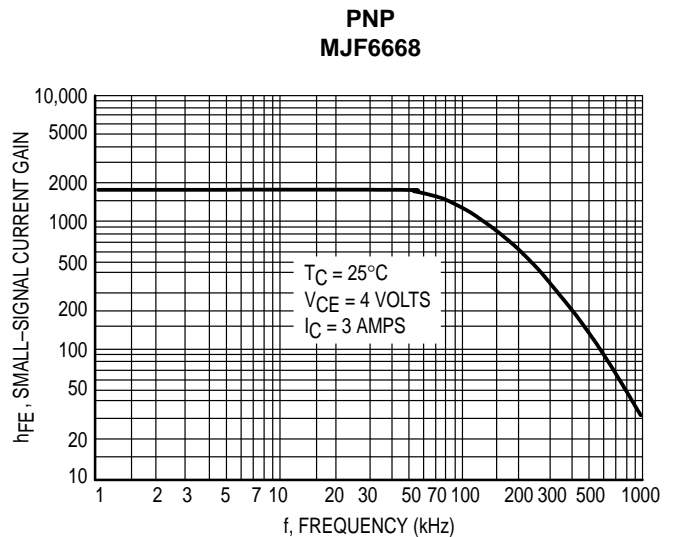
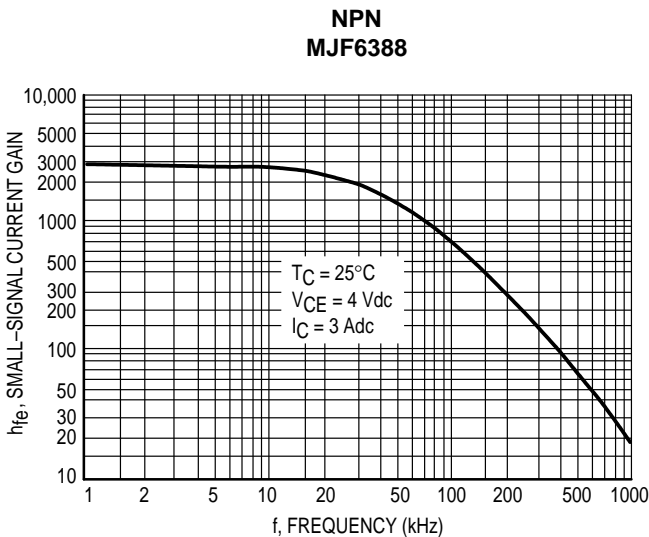
**Figure 5. Thermal Response**



**Figure 6. Maximum Power Derating**

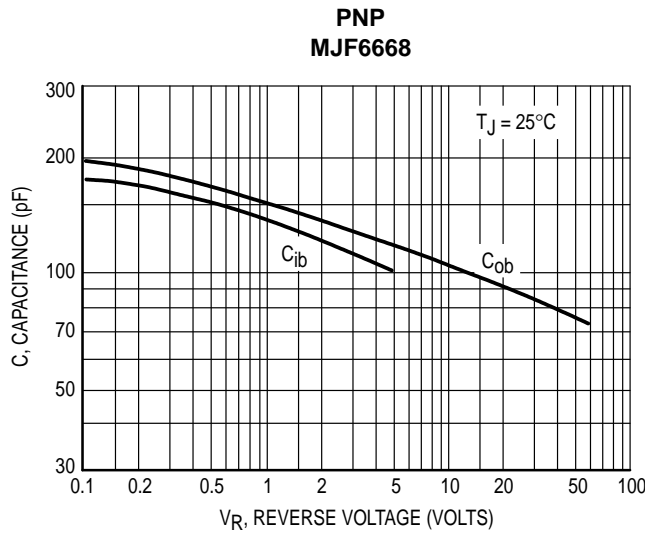
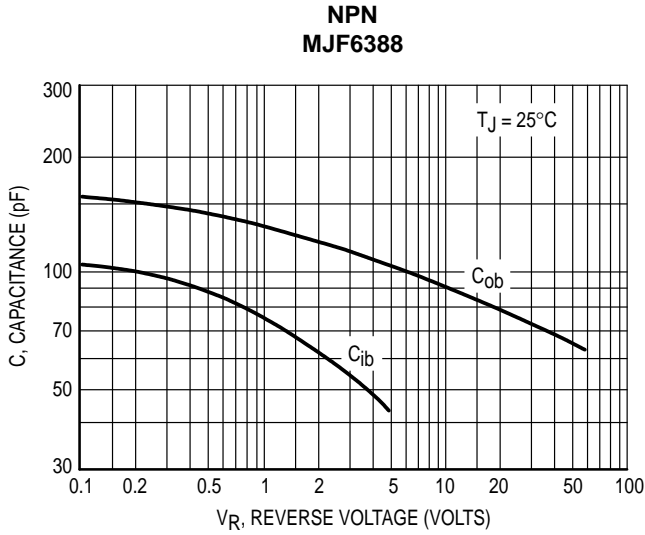
There are two limitations on the power handling ability of a transistor: average junction temperature and second breakdown. Safe operating area curves indicate  $I_C - V_{CE}$  limits of the transistor that must be observed for reliable operation; i.e., the transistor must not be subjected to greater dissipation than the curves indicate.

The data of Figure 4 is based on  $T_{J(pk)} = 150\text{°C}$ ;  $T_C$  is variable depending on conditions. Secondary breakdown pulse limits are valid for duty cycles to 10% provided  $T_{J(pk)} < 150\text{°C}$ .  $T_{J(pk)}$  may be calculated from the data in Figure 5. At high case temperatures, thermal limitations will reduce the power that can be handled to values less than the limitations imposed by secondary breakdown.

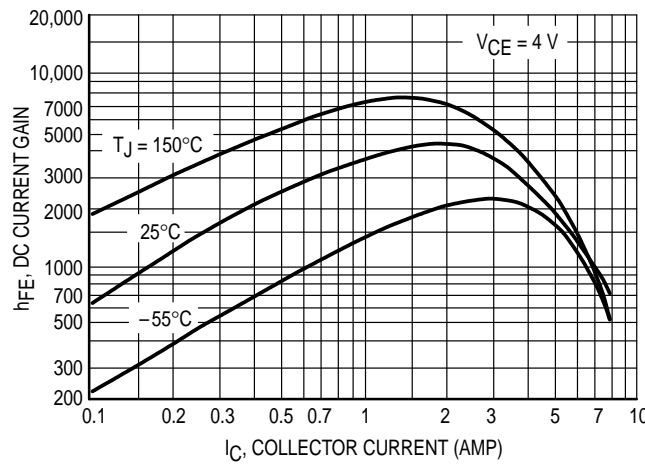
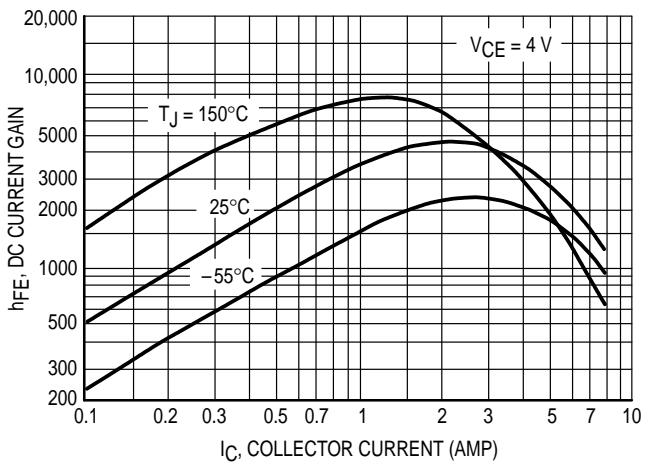


**Figure 7. Typical Small-Signal Current Gain**

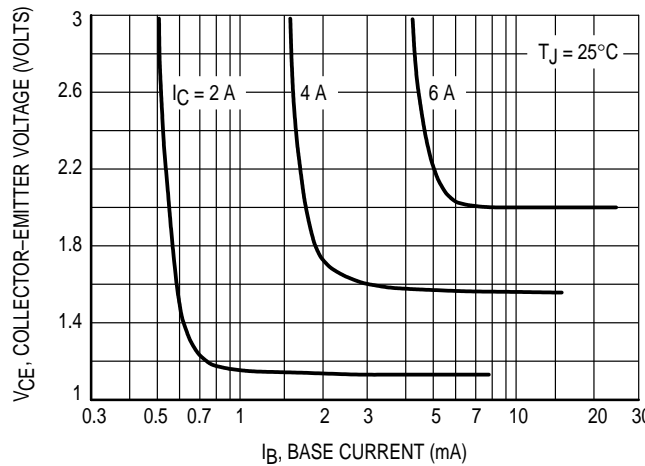
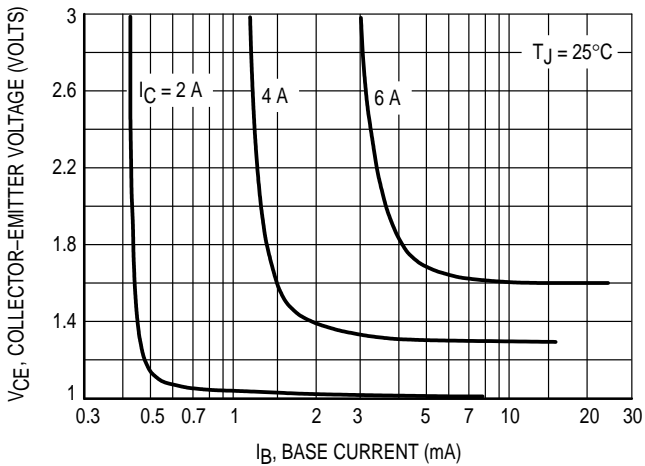
**MJF6388 MJF6668**



**Figure 8. Typical Capacitance**

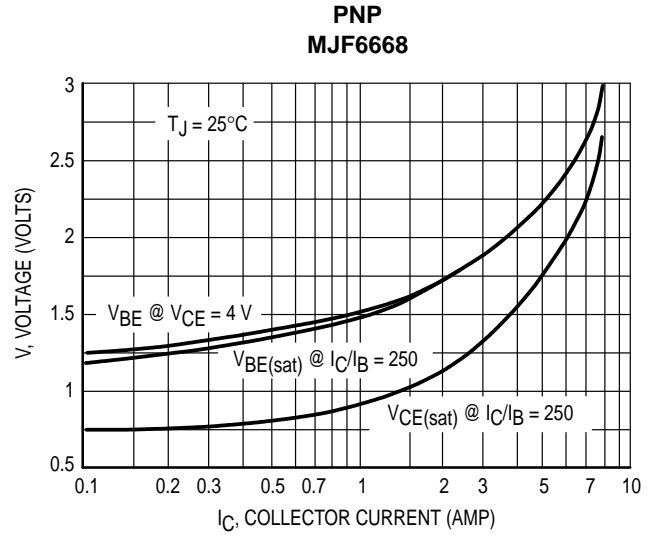
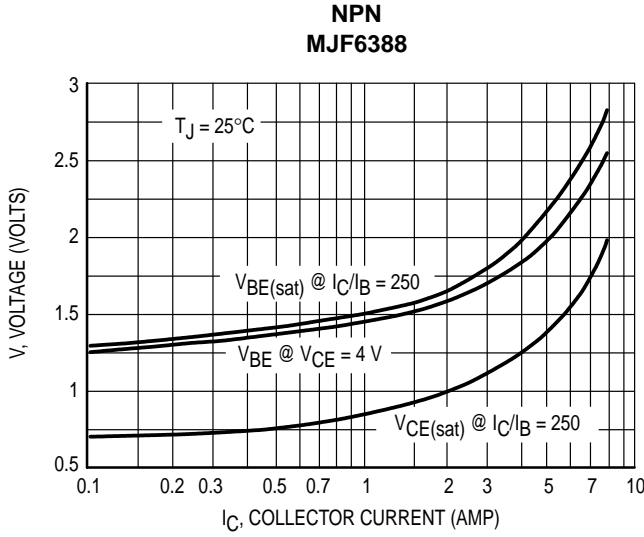


**Figure 9. Typical DC Current Gain**

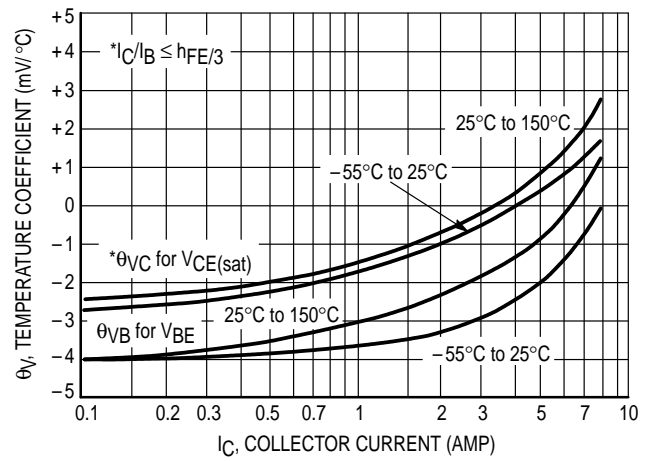
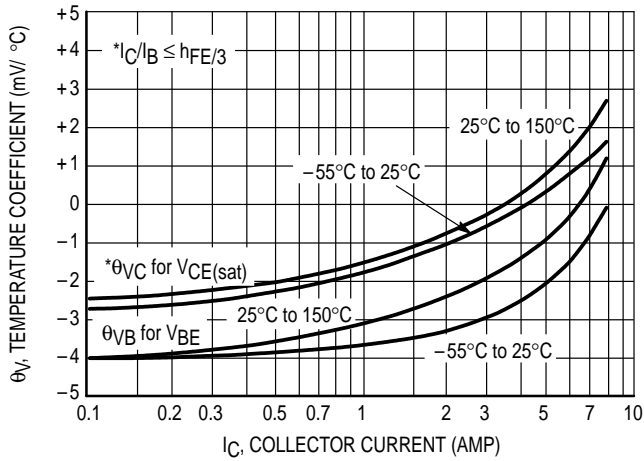


**Figure 10. Typical Collector Saturation Region**

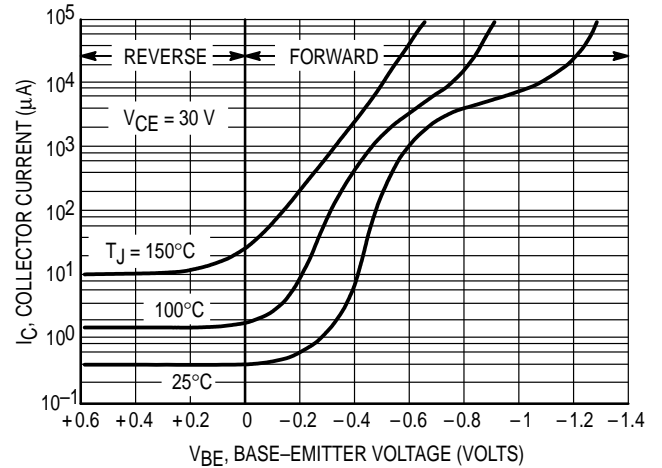
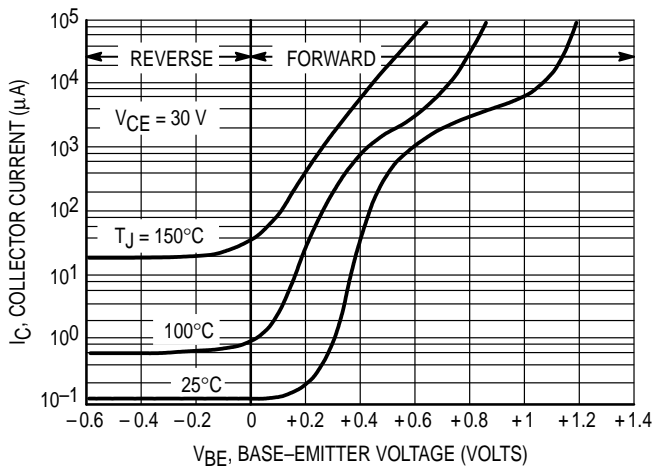
**MJF6388 MJF6668**



**Figure 11. Typical "On" Voltages**



**Figure 12. Typical Temperature Coefficients**



**Figure 13. Typical Collector Cut-Off Region**

TEST CONDITIONS FOR ISOLATION TESTS\*

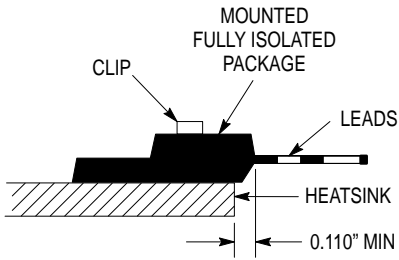


Figure 14. Clip Mounting Position for Isolation Test Number 1

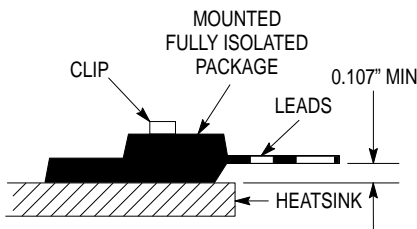


Figure 15. Clip Mounting Position for Isolation Test Number 2

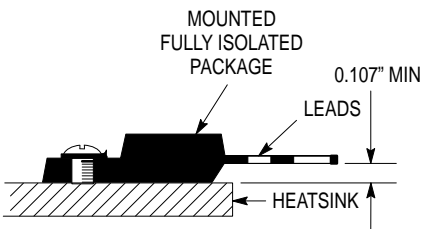


Figure 16. Screw Mounting Position for Isolation Test Number 3

\* Measurement made between leads and heatsink with all leads shorted together

MOUNTING INFORMATION

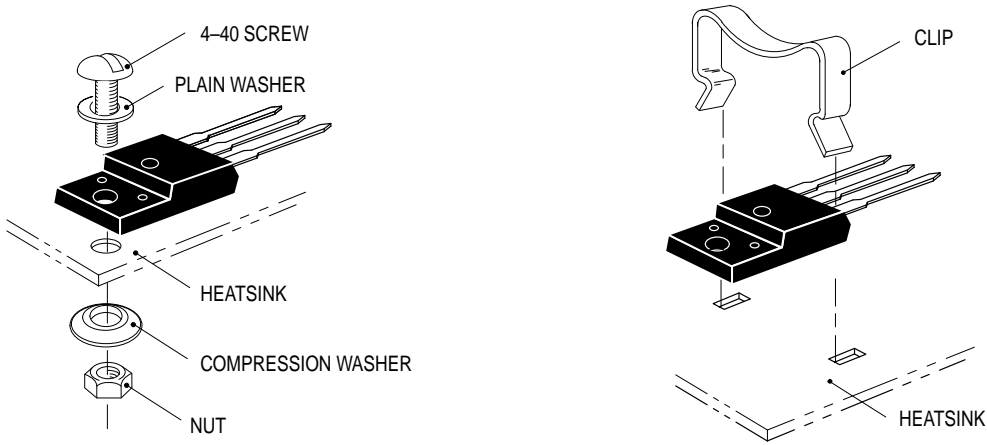


Figure 17. Typical Mounting Techniques\*

Laboratory tests on a limited number of samples indicate, when using the screw and compression washer mounting technique, a screw torque of 6 to 8 in · lbs is sufficient to provide maximum power dissipation capability. The compression washer helps to maintain a constant pressure on the package over time and during large temperature excursions.

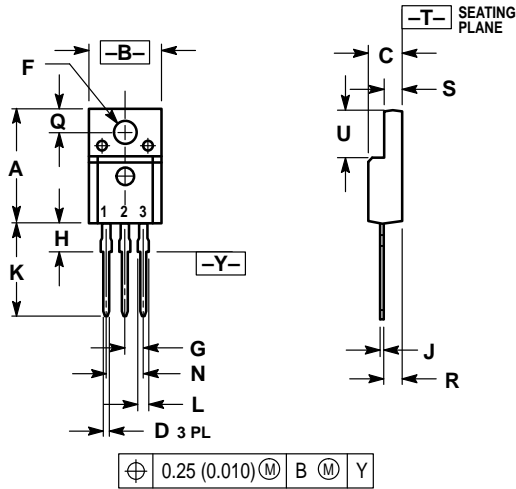
Destructive laboratory tests show that using a hex head 4-40 screw, without washers, and applying a torque in excess of 20 in · lbs will cause the plastic to crack around the mounting hole, resulting in a loss of isolation capability.

Additional tests on slotted 4-40 screws indicate that the screw slot fails between 15 to 20 in · lbs without adversely affecting the package. However, in order to positively ensure the package integrity of the fully isolated device, Motorola does not recommend exceeding 10 in · lbs of mounting torque under any mounting conditions.

\*\* For more information about mounting power semiconductors see Application Note AN1040.

**MJF6388 MJF6668**

**PACKAGE DIMENSIONS**



- NOTES:  
 1. DIMENSIONING AND TOLERANCING PER ANSI Y14.5M, 1982.  
 2. CONTROLLING DIMENSION: INCH.

DIM	INCHES		MILLIMETERS	
	MIN	MAX	MIN	MAX
A	0.621	0.629	15.78	15.97
B	0.394	0.402	10.01	10.21
C	0.181	0.189	4.60	4.80
D	0.026	0.034	0.67	0.86
F	0.121	0.129	3.08	3.27
G	0.100 BSC		2.54 BSC	
H	0.123	0.129	3.13	3.27
J	0.018	0.025	0.46	0.64
K	0.500	0.562	12.70	14.27
L	0.045	0.060	1.14	1.52
N	0.200 BSC		5.08 BSC	
Q	0.126	0.134	3.21	3.40
R	0.107	0.111	2.72	2.81
S	0.096	0.104	2.44	2.64
U	0.259	0.267	6.58	6.78

- STYLE 2:  
 PIN 1. BASE  
 2. COLLECTOR  
 3. EMITTER

**CASE 221D-02  
 TO-220 TYPE  
 ISSUE D**

Motorola reserves the right to make changes without further notice to any products herein. Motorola makes no warranty, representation or guarantee regarding the suitability of its products for any particular purpose, nor does Motorola assume any liability arising out of the application or use of any product or circuit, and specifically disclaims any and all liability, including without limitation consequential or incidental damages. "Typical" parameters can and do vary in different applications. All operating parameters, including "Typicals" must be validated for each customer application by customer's technical experts. Motorola does not convey any license under its patent rights nor the rights of others. Motorola products are not designed, intended, or authorized for use as components in systems intended for surgical implant into the body, or other applications intended to support or sustain life, or for any other application in which the failure of the Motorola product could create a situation where personal injury or death may occur. Should Buyer purchase or use Motorola products for any such unintended or unauthorized application, Buyer shall indemnify and hold Motorola and its officers, employees, subsidiaries, affiliates, and distributors harmless against all claims, costs, damages, and expenses, and reasonable attorney fees arising out of, directly or indirectly, any claim of personal injury or death associated with such unintended or unauthorized use, even if such claim alleges that Motorola was negligent regarding the design or manufacture of the part. Motorola and  $\textcircled{M}$  are registered trademarks of Motorola, Inc. Motorola, Inc. is an Equal Opportunity/Affirmative Action Employer.

**How to reach us:**

**USA / EUROPE:** Motorola Literature Distribution;  
 P.O. Box 20912; Phoenix, Arizona 85036. 1-800-441-2447

**JAPAN:** Nippon Motorola Ltd.; Tatsumi-SPD-JLDC, Toshikatsu Otsuki,  
 6F Seibu-Butsuryu-Center, 3-14-2 Tatsumi Koto-Ku, Tokyo 135, Japan. 03-3521-8315

**MFAX:** RMFAX0@email.sps.mot.com - TOUCHTONE (602) 244-6609  
**INTERNET:** http://Design-NET.com

**HONG KONG:** Motorola Semiconductors H.K. Ltd.; 8B Tai Ping Industrial Park,  
 51 Ting Kok Road, Tai Po, N.T., Hong Kong. 852-26629298

