

MN3206

128-STAGE LOW VOLTAGE OPERATION LOW NOISE BBD

General description

The MN3206 is a 128-stage low voltage operation ($V_{DD} = 5V$) BBD that provides a signal delay of up to 6.4ms and is suitable for use as reverberation effect of audio equipments operated by low voltage such as portable stereo and radio cassette recorder.

Features

- Variable delay of audio signals: 0.32ms ~ 6.4ms.
- Wide power supply voltage: 4 ~ 10V.
- No insertion loss: $L_i = 0dB$ typ.
- Wide dynamic range: $S/N = 83dB$ typ.
- Low distortion: $THD = 0.3\%$ typ. ($V_i = 0.25V_{rms}$)
- Clock frequency range: 10KHz ~ 200KHz.
- N channel silicon gate process.
- 8-Lead Dual-In-Line Plastic Package.

Applications

- Reverberation and echo effects of audio equipments such as radio cassette recorder, car radio, portable radio, portable stereo, echo microphone and pre-taped musical accompaniment (Karaoke), etc.
- Sound effect in electronic musical instruments.
- Variable or fixed delay of analog signals.

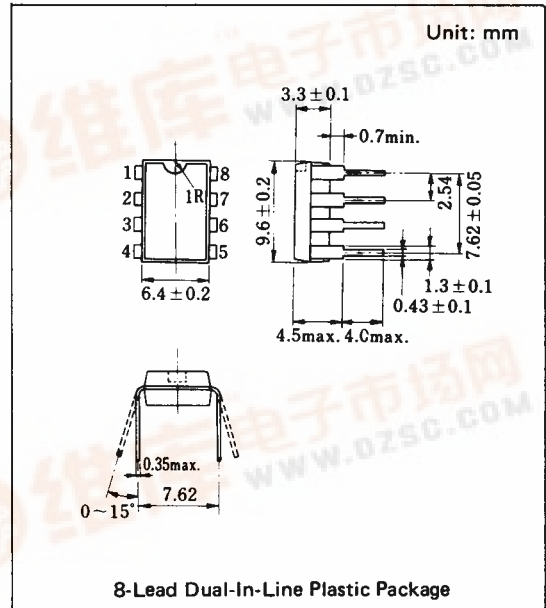

Block Diagram

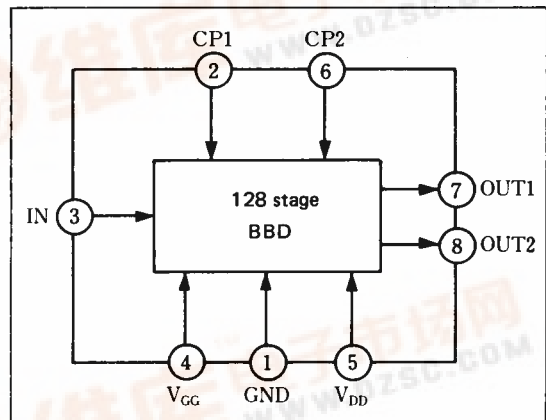

Quick Reference Data

Item	Symbol	Value	Unit
Supply Voltage	V_{DD}, V_{GG}	+ 5, $\frac{1}{3}V_{DD}$	V
Signal Delay Time	t_D	0.32~6.4	ms
Total Harmonic Distortion	THD	0.3	%
Signal to Noise Ratio	S/N	83	dB

■ Absolute Maximum Ratings (Ta = 25°C)

Item	Symbol	Ratings	Unit
Terminal Voltage	V _{DD} , V _{GG} , V _{CP} , V _I	-0.3~+11	V
Output Voltage	V _O	-0.3~+11	V
Operating Temperature	T _{opr}	-20~+70	°C
Storage Temperature	T _{stg}	-55~+125	°C

■ Operating Condition (Ta = 25°C)

Item	Symbol	Condition	Min.	Typ.	Max.	Unit
Drain Supply Voltage	V _{DD}		+4	+5	+10	V
Gate Supply Voltage	V _{GG}			$\frac{14}{15} V_{DD}$		V
Clock Voltage "H" Level	V _{CPH}			V _{DD}		V
Clock Voltage "L" Level	V _{CPL}		0		+1	V
Clock Frequency	f _{CP}		10		200	kHz
Clock Pulse Width *1	t _{CPW}				0.5T *2	
Clock Rise Time *1	t _{CPr}				500	ns
Clock Fall Time *1	t _{CPf}				500	ns
Clock Input Capacitance	C _{CP}				700	pF
Clock Cross Point *1	V _X		0		0.3V _{CPH}	V

■ Electrical Characteristics (Ta=25°C, V_{DD}=V_{CPH}=5V, V_{CPL}=0V, V_{GG}= $\frac{14}{15} V_{DD}$, R_L=100kΩ)

Item	Symbol	Condition	Min.	Typ.	Max.	Unit
Signal Delay Time	t _D		0.32		6.4	ms
Input Signal Frequency	f _i	f _{CP} = 40kHz, Output -3dB down	12			kHz
Input Signal Swing	V _i	THD=2.5%	0.6			Vrms
Insertion Loss	L _i	f _{CP} =40kHz, f _i =1kHz	-4	0	4	dB
Total Harmonic Distortion	THD	f _{CP} =40kHz, f _i =1kHz, V _i =0.25Vrms		0.3	2.5	%
Noise Voltage	V _{no}	f _{CP} = 100kHz, Weighted by "A" curve			0.1	mVrms
Signal to Noise Ratio	S/N			83		dB

*1 Clock Pulse Waveforms

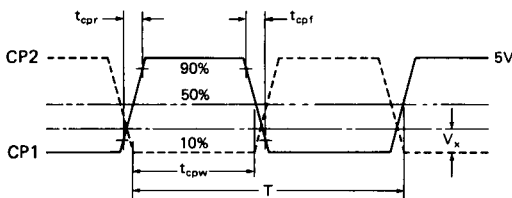

*2 T = 1/f_{CP} (Clock Period)

■ Terminal Assignments

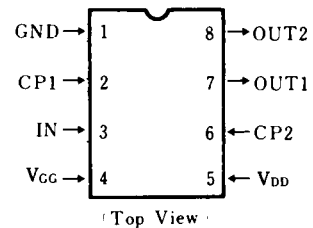

■ Circuit Diagram

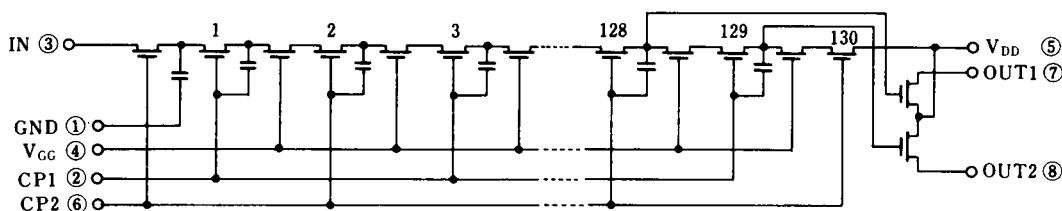

Typical Electrical Characteristic Curves

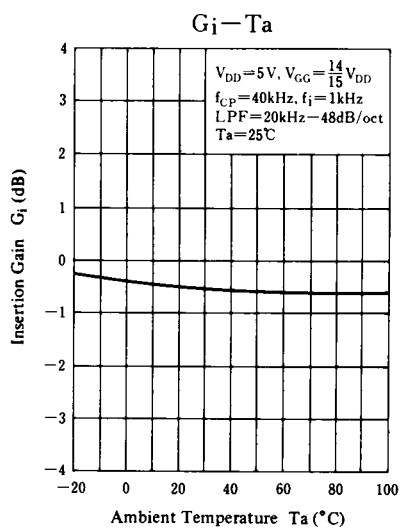
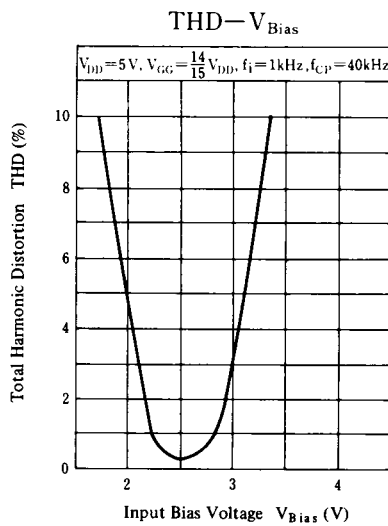
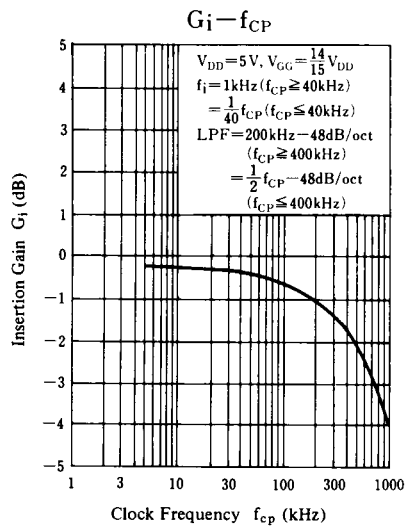
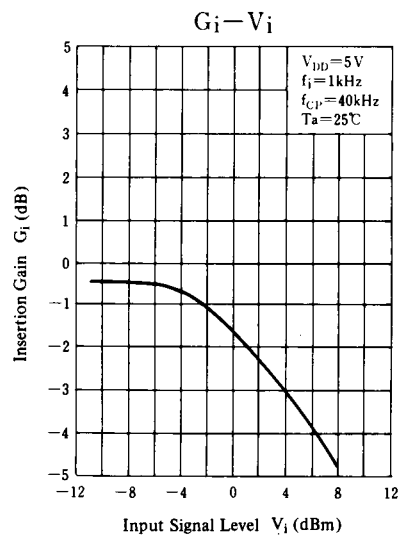
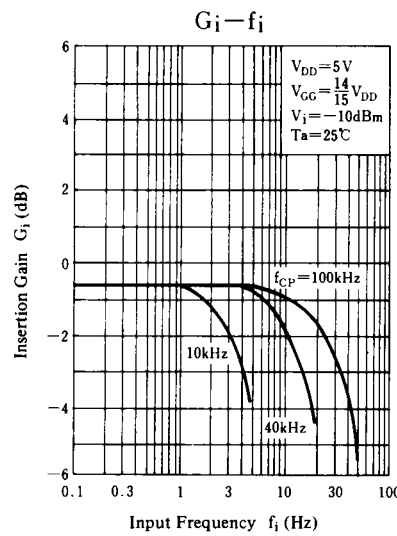
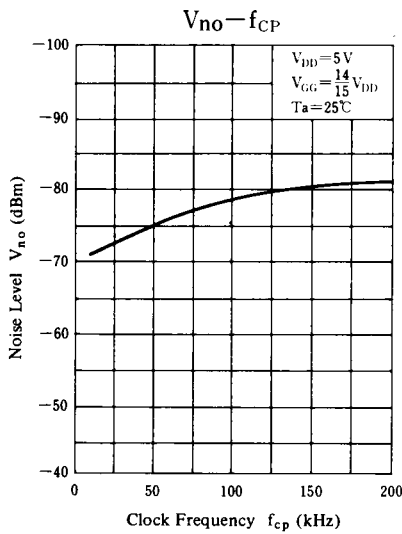
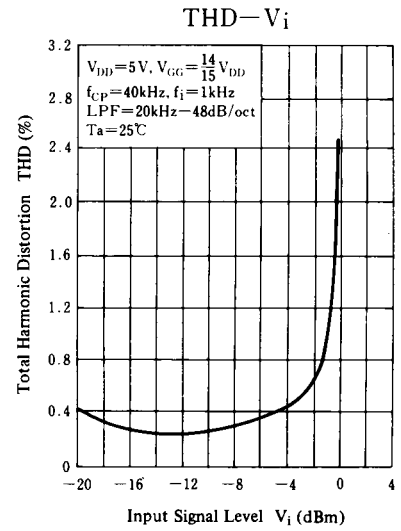
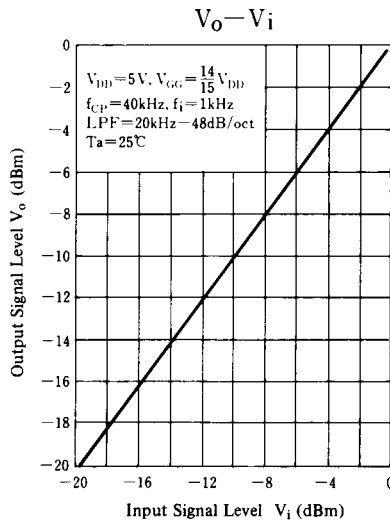
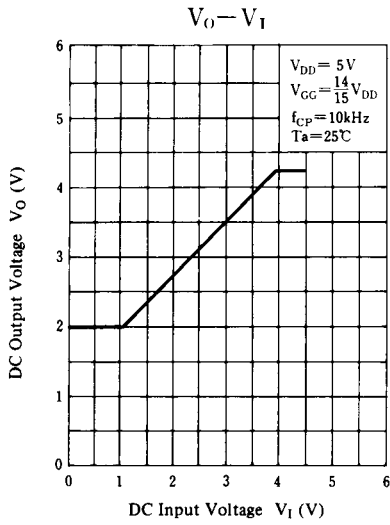

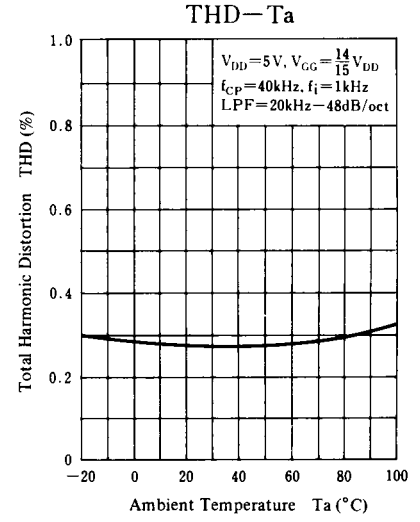
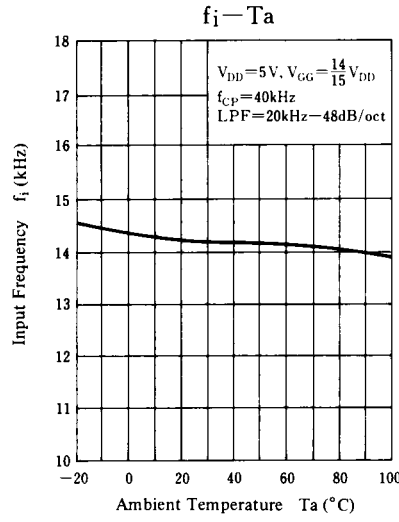
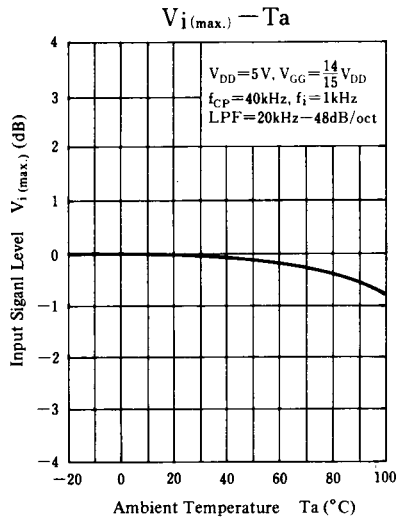

Supply Voltage Characteristics

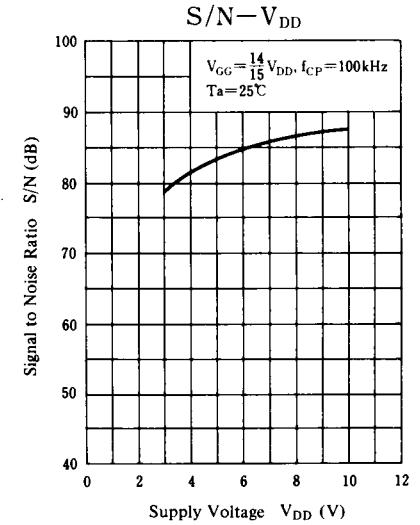
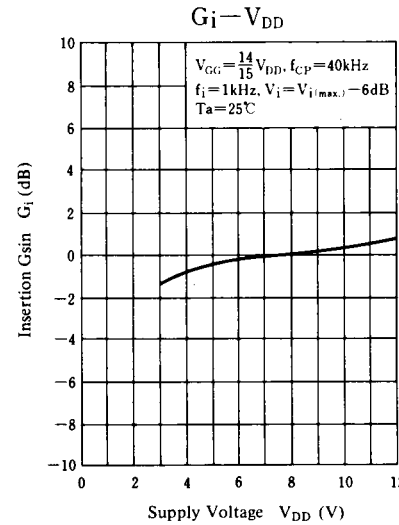
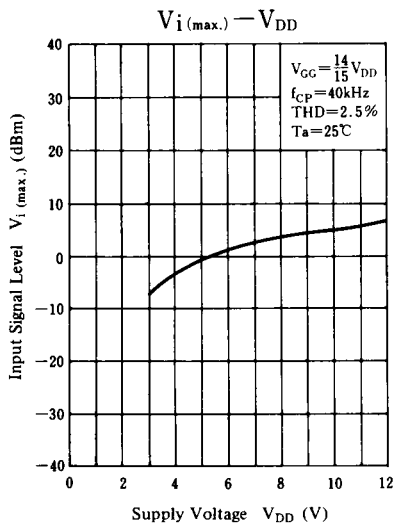
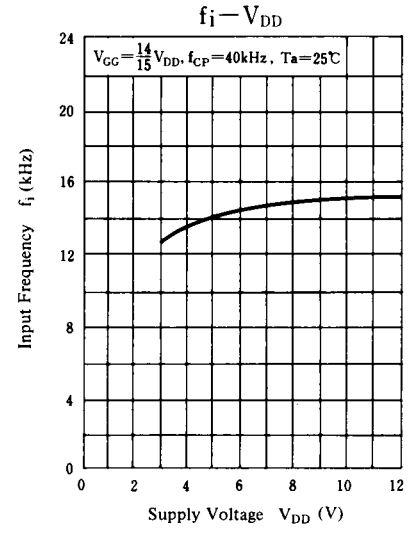
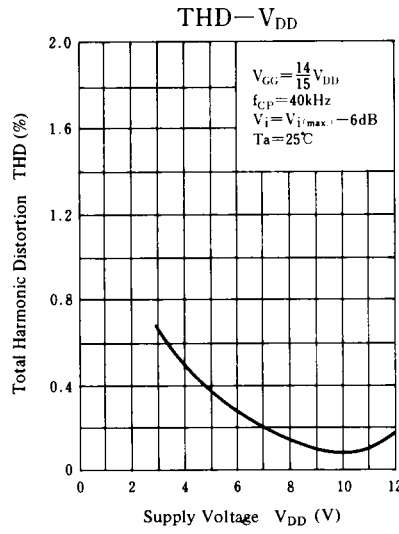
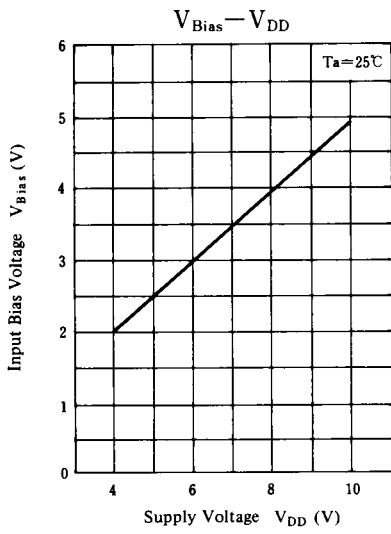

■ Application Circuit

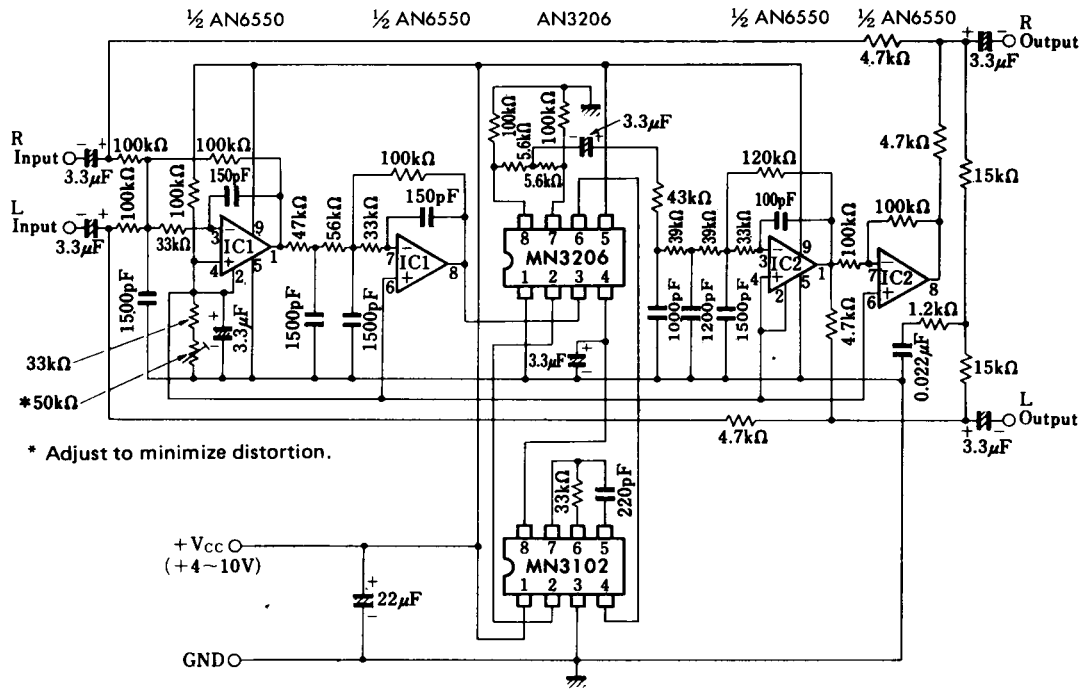

Vibrato and/or chorus effects Generation Circuit