



# MP7523/XRD7523

15 V CMOS  
 Multiplying 8-Bit  
 Digital-to-Analog Converter

January 1996-2

## FEATURES

- Full Four-Quadrant Multiplying
- Low Feedthrough: 1/2 LSB @ 200 kHz
- Fast Settling: 100 ns (typ.)
- Low Power Dissipation
- Low Cost
- 5 V/15 V Operation
- Buffered Version: MP7524/XRD7524

## APPLICATIONS

- Battery Operated Equipment
- Low Power, Ratiometric A/D Converters
- Digitally Controlled Gain Circuits
- Digitally Controlled Attenuators
- CRT Character Generation
- Low Noise Audio Gain Control

## GENERAL DESCRIPTION

The MP7523/XRD7523 is a low cost multiplying Digital-to-Analog Converter. The device uses an advanced thin-film-on-CMOS technology to provide 8-bit resolution with accuracy to 10-bits and very low power dissipation.

The MP7523/XRD7523's excellent multiplying characteristics and low cost allow it to be used in a wide ranging field of applications such as: low noise audio gain control, CRT character generation, motor speed control, digitally controlled attenuators, etc.

## SIMPLIFIED BLOCK DIAGRAM

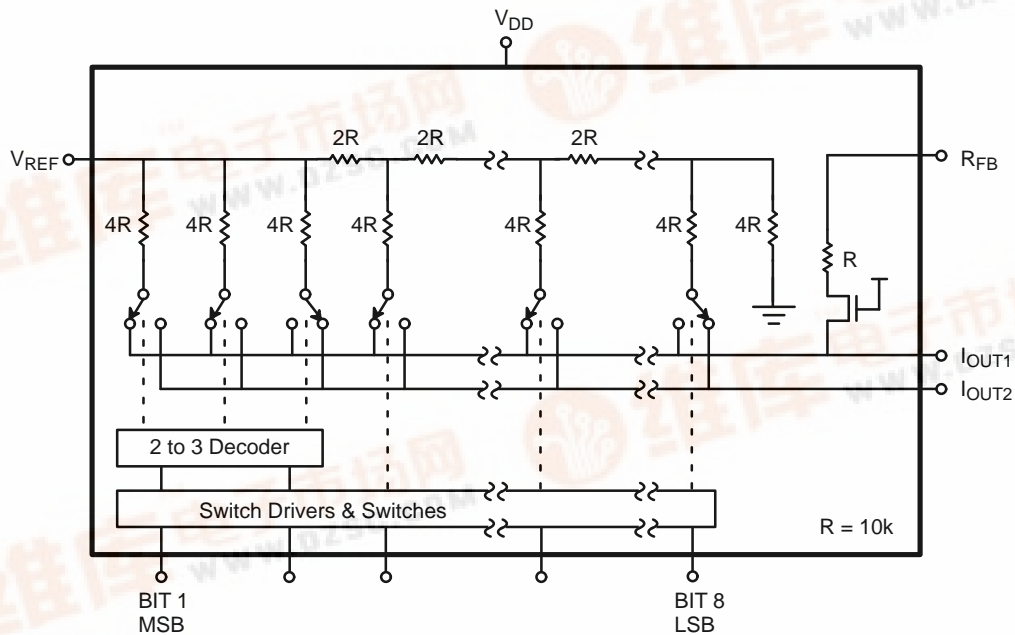

**3 Segment D/A Converter with Termination to DGND**  
 Logical "1" at Digital Input Steers Current to I<sub>OUT1</sub>



# MP7523/XRD7523



## ORDERING INFORMATION

Package Type	Temperature Range	Part No.	INL (LSB)	DNL (LSB)	Gain Error (% FSR)
Plastic Dip	-40 to +85°C	MP7523JN	±1/2	±1	±1.8
Plastic Dip	-40 to +85°C	MP7523KN	±1/4	±1	±1.8
SOIC (Jedec, 0.300")	-40 to +85°C	MP7523JS	±1/2	±1	±1.8
SOIC (Jedec, 0.300")	-40 to +85°C	MP7523KS	±1/4	±1	±1.8
SOIC (Jedec, 0.150")	-40 to +85°C	XRD7523AID-J	±1/2	±1	±1.8
SOIC (Jedec, 0.150")	-40 to +85°C	XRD7523AID-K	±1/4	±1	±1.8
SOP (EIAJ)	-40 to +85°C	XRD7523AIK-J	±1/2	±1	±1.8
SOP (EIAJ)	-40 to +85°C	XRD7523AIK-K	±1/4	±1	±1.8

## PIN CONFIGURATIONS

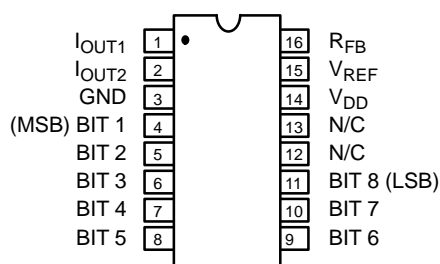

16 Pin PDIP (0.300")

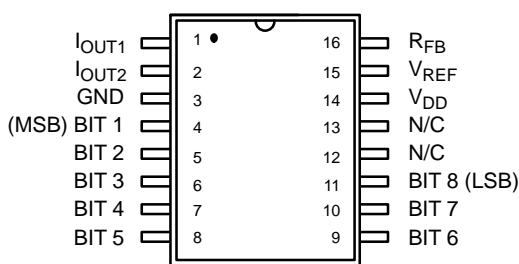

16 pin SOIC (Jedec, 0.300")  
16 pin SOIC (Jedec, 0.150")  
16 pin SOP (EIAJ, 5.5 mm)

## PIN OUT DEFINITIONS

PIN NO.	NAME	DESCRIPTION
1	I <sub>OUT1</sub>	Current Output 1
2	I <sub>OUT2</sub>	Current Output 2
3	GND	Ground
4	BIT 1	Bit 1 (MSB)
5	BIT 2	Bit 2
6	BIT 3	Bit 3
7	BIT 4	Bit 4
8	BIT 5	Bit 5

PIN NO.	NAME	DESCRIPTION
9	BIT 6	Bit 6
10	BIT 7	Bit 7
11	BIT 8	Bit 8
12	N/C	No Connection
13	N/C	No Connection
14	V <sub>DD</sub>	Positive Power Supply
15	V <sub>REF</sub>	Reference Input Voltage
16	R <sub>FB</sub>	Internal Feedback Resistor

## ELECTRICAL CHARACTERISTICS

( $V_{DD} = +15\text{ V}$ ,  $V_{REF} = +10\text{ V}$  unless otherwise noted)

Parameter	Symbol	25°C			Tmin to Tmax		Units	Test Conditions/Comments
		Min	Typ	Max	Min	Max		
<b>STATIC PERFORMANCE<sup>1</sup></b>								
Resolution (All Grades)	N	8			8		Bits	
Integral Non-Linearity (Relative Accuracy)	INL						LSB	Best Fit Straight Line (Max INL – Min INL) / 2
J				±1/2		±1/2		
K				±1/4		±1/4		
Monotonicity								Guaranteed over temp
Differential Non-Linearity	DNL						LSB	All grades monotonic over full temperature range.
J				±1		±1		
K				±1		±1		
Gain Error	GE			±1.5		±1.8	%	Using Internal $R_{FB}$ Digital Inputs = $V_{INH}$
J								
K								
Power Supply Rejection Ratio	PSRR			±200		±300	ppm/%	$ \Delta\text{Gain}/\Delta V_{DD}  \Delta V_{DD} = \pm 5\%$ Digital Inputs = $V_{INH}$
J								
K								
Output Leakage Current (Pin 1)	$I_{OUT1}$			±50nA		±200nA	nA	Digital Inputs = $V_{INL}$
J								
K								
Output Leakage Current (Pin 2)	$I_{OUT2}$			±50nA		±200nA	nA	Digital Inputs = $V_{INH}$
J								
K								
<b>REFERENCE INPUT</b>								
Input Resistance	$R_{IN}$	5		20	5	20	kΩ	$V_{OUT1} = V_{OUT2} = 0\text{ V}$
<b>DIGITAL INPUTS</b>								
Logical "1" Voltage	$V_{IH}$	14.5			14.5		V	
Logical "0" Voltage	$V_{IL}$			0.5		0.5	V	
Input Leakage Current	$I_{LKG}$			±1		±1	μA	
<b>ANALOG OUTPUTS</b>								
Output Capacitance <sup>2</sup>								
	$C_{OUT1}$			100		100	pF	DAC Inputs all 1's
	$C_{OUT1}$			30		30	pF	DAC Inputs all 0's
	$C_{OUT2}$			30		30	pF	DAC Inputs all 1's
	$C_{OUT2}$			100		100	pF	DAC Inputs all 0's

## ELECTRICAL CHARACTERISTICS (CON'T)

Parameter	Symbol	25°C			Tmin to Tmax		Units	Test Conditions/Comments
		Min	Typ	Max	Min	Max		
<b>POWER SUPPLY</b>								
Functional Voltage Range <sup>2</sup>	V <sub>DD</sub>	5		16	5	16	V	All digital inputs = 0 V or all = 15 V
Supply Current	I <sub>DD</sub>			1.6		1.6	mA	

### NOTES:

- 1 Full Scale Range (FSR) is 10V.
- 2 Guaranteed but not production tested.
- 3 Digital input levels should not go below ground or exceed the positive supply voltage, otherwise damage may occur.
- 4 Specified values guarantee functionality. Refer to other parameters for accuracy.

**Specifications are subject to change without notice**

## ABSOLUTE MAXIMUM RATINGS (TA = +25°C unless otherwise noted)<sup>1, 2</sup>

V <sub>DD</sub> to GND	+17 V	Storage Temperature	-65°C to +150°C
Digital Input Voltage to GND	GND -0.5 to V <sub>DD</sub> +0.5 V	Lead Temperature (Soldering, 10 seconds)	+300°C
I <sub>OUT1</sub> , I <sub>OUT2</sub> to GND	-0.5 to 6.5 V	Package Power Dissipation Rating to 75°C	
V <sub>REF</sub> to GND	±25 V	CDIP, PDIP, SOIC	800mW
V <sub>RFB</sub> to GND	±25 V	Derates above 75°C	11mW/°C

### NOTES:

- 1 Stresses above those listed under "Absolute Maximum Ratings" may cause permanent damage to the device. This is a stress rating only and functional operation at or above this specification is not implied. Exposure to maximum rating conditions for extended periods may affect device reliability.
- 2 Any input pin which can see a value outside the absolute maximum ratings should be protected by Schottky diode clamps (HP5082-2835) from input pin to the supplies.

## APPLICATION NOTES

Refer to Section 8 in the 1995 Data Acquisition Products databook for Applications Information

**16 LEAD PLASTIC DUAL-IN-LINE  
(300 MIL PDIP)**

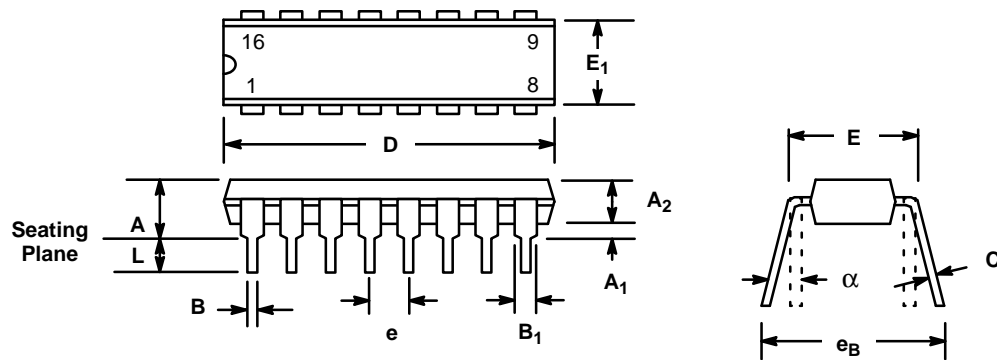

SYMBOL	INCHES		MILLIMETERS	
	MIN	MAX	MIN	MAX
A	0.145	0.210	3.68	5.33
A <sub>1</sub>	0.015	0.070	0.38	1.78
A <sub>2</sub>	0.115	0.195	2.92	4.95
B	0.014	0.024	0.36	0.56
B <sub>1</sub>	0.030	0.070	0.76	1.78
C	0.008	0.014	0.20	0.38
D	0.745	0.840	18.92	21.34
E	0.300	0.325	7.62	8.26
E <sub>1</sub>	0.240	0.280	6.10	7.11
e	0.100 BSC		2.54 BSC	
e <sub>B</sub>	0.310	0.430	7.87	10.92
L	0.115	0.160	2.92	4.06
α	0°	15°	0°	15°

## 16 LEAD SMALL OUTLINE (150 MIL JEDEC SOIC)

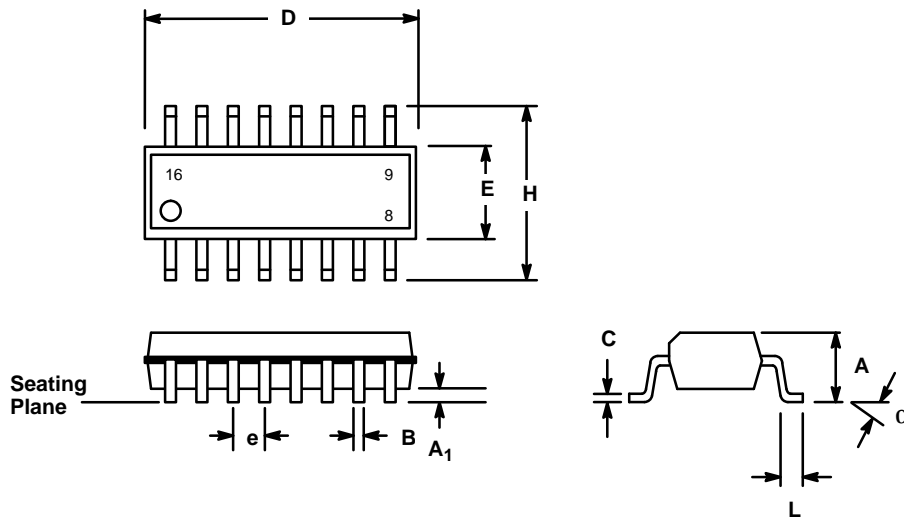

SYMBOL	INCHES		MILLIMETERS	
	MIN	MAX	MIN	MAX
A	0.053	0.069	1.35	1.75
A <sub>1</sub>	0.004	0.010	0.10	0.25
B	0.013	0.020	0.33	0.51
C	0.007	0.010	0.19	0.25
D	0.386	0.394	9.80	10.00
E	0.150	0.157	3.80	4.00
e	0.050 BSC		1.27 BSC	
H	0.228	0.244	5.80	6.20
L	0.016	0.050	0.40	1.27
α	0°	8°	0°	8°

**16 LEAD SMALL OUTLINE  
(300 MIL JEDEC SOIC)**

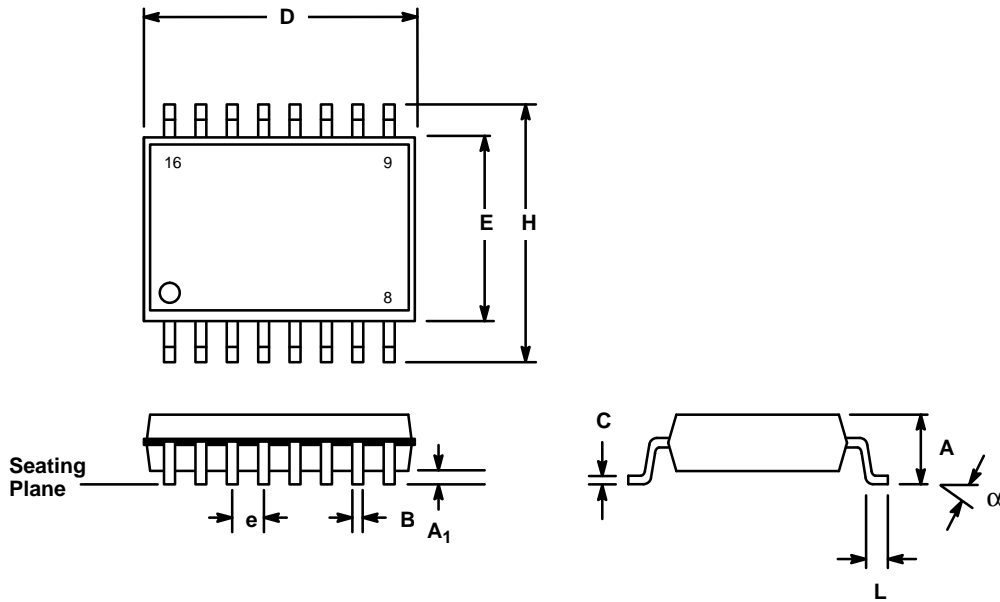

SYMBOL	INCHES		MILLIMETERS	
	MIN	MAX	MIN	MAX
A	0.093	0.104	2.35	2.65
A <sub>1</sub>	0.004	0.012	0.10	0.30
B	0.013	0.020	0.33	0.51
C	0.009	0.013	0.23	0.32
D	0.398	0.413	10.10	10.50
E	0.291	0.299	7.40	7.60
e	0.050 BSC		1.27 BSC	
H	0.394	0.419	10.00	10.65
L	0.016	0.050	0.40	1.27
α	0°	8°	0°	8°

## 16 LEAD EIAJ SMALL OUTLINE (5.5 mm EIAJ SOP)

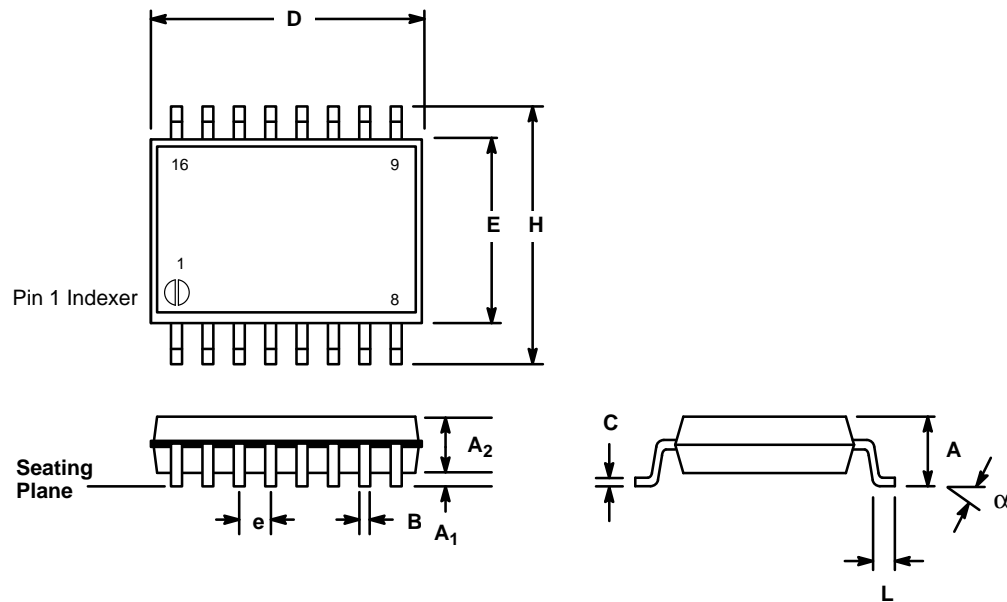

SYMBOL	MILLIMETERS		INCHES	
	MIN	MAX	MIN	MAX
A	1.80	2.40	0.071	0.095
A <sub>1</sub>	0.02	0.20	0.001	0.008
A <sub>2</sub>	1.80	2.20	0.079	0.087
B	0.30	0.50	0.012	0.020
C	0.13	0.20	0.005	0.008
D	9.9	10.5	0.390	0.414
E	5.30	5.70	0.209	0.224
e	1.27 BSC		0.050 BSC	
H	7.80	8.20	0.307	0.323
L	0.30	0.90	0.012	0.035
α	0°	15°	0°	15°



# Notes

# Notes

# Notes

## NOTICE

EXAR Corporation reserves the right to make changes to the products contained in this publication in order to improve design, performance or reliability. EXAR Corporation assumes no responsibility for the use of any circuits described herein, conveys no license under any patent or other right, and makes no representation that the circuits are free of patent infringement. Charts and schedules contained here in are only for illustration purposes and may vary depending upon a user's specific application. While the information in this publication has been carefully checked; no responsibility, however, is assumed for inaccuracies.

EXAR Corporation does not recommend the use of any of its products in life support applications where the failure or malfunction of the product can reasonably be expected to cause failure of the life support system or to significantly affect its safety or effectiveness. Products are not authorized for use in such applications unless EXAR Corporation receives, in writing, assurances to its satisfaction that: (a) the risk of injury or damage has been minimized; (b) the user assumes all such risks; (c) potential liability of EXAR Corporation is adequately protected under the circumstances.

Copyright EXAR Corporation  
Datasheet December 1996

Reproduction, in part or whole, without the prior written consent of EXAR Corporation is prohibited.