

The RF MOSFET Line  
**RF Power**  
**Field Effect Transistor**  
**N-Channel Enhancement-Mode Lateral**  
**MOSFET**

**MRF3010**

**10 W, 1.6 GHz, 28 V**  
**LATERAL N-CHANNEL**  
**BROADBAND**  
**RF POWER MOSFET**

Designed for IMARSAT satellite up link at 1.6 to 1.64 GHz, 28 volts, Class AB, CW amplifier applications.

- Guaranteed Performance @ 1.6 GHz, 28 Volts  
 Output Power = 10 Watts  
 Minimum Gain = 9.5 dB @ 10 Watts  
 Minimum Efficiency = 45% @ 10 Watts
- High Gain, Rugged Device
- Bottom Side Source Eliminates DC Isolators, Reducing Common Mode Inductances
- Broadband Performance of This Device Makes It Ideal for Applications from 800 to 1700 MHz, Common-Source Class AB Operation.
- Typical Performance at Class A Operation:  
 $P_{out} = 2$  Watts,  $V_{DD} = 28$  Volts,  $I_{DQ} = 1$  A,  
 Gain = 12.5 dB, IMD = -32 dB
- Characterized with Small-Signal S-Parameters from 500 to 2500 MHz
- Capable of Handling 30:1 VSWR, @ 28 Vdc
- Circuit Board Available Upon Request by Contacting RF Tactical Marketing in Phoenix, AZ

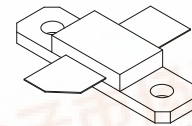
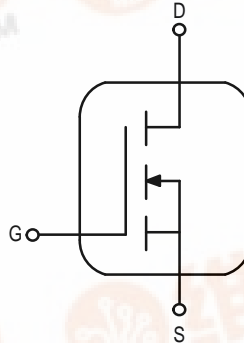

**CASE 360B-01, STYLE 1**

**MAXIMUM RATINGS**

Rating	Symbol	Value	Unit
Drain-Source Voltage	$V_{DSS}$	65	Vdc
Gate-Source Voltage	$V_{GS}$	$\pm 20$	Vdc
Storage Temperature Range	$T_{stg}$	- 65 to +150	$^{\circ}C$
Operating Junction Temperature	$T_J$	200	$^{\circ}C$

**ELECTRICAL CHARACTERISTICS** ( $T_C = 25^{\circ}C$  unless otherwise noted)

Characteristic	Symbol	Min	Typ	Max	Unit
----------------	--------	-----	-----	-----	------

**OFF CHARACTERISTICS**

Drain-Source Breakdown Voltage ( $V_{GS} = 0$ , $I_D = 1 \mu A$ )	$V_{(BR)DSS}$	65	-	-	Vdc
Zero Gate Voltage Drain Current ( $V_{DS} = 28$ V, $V_{GS} = 0$ )	$I_{DSS}$	-	-	10	$\mu A_{dc}$
Gate-Source Leakage Current ( $V_{GS} = 20$ V, $V_{DS} = 0$ )	$I_{GSS}$	-	-	1	$\mu A_{dc}$

**NOTE - CAUTION** - MOS devices are susceptible to damage from electrostatic charge. Reasonable precautions in handling and packaging MOS devices should be observed.

**ELECTRICAL CHARACTERISTICS – continued** ( $T_C = 25^\circ\text{C}$  unless otherwise noted)

Characteristic	Symbol	Min	Typ	Max	Unit
<b>ON CHARACTERISTICS</b>					
Gate Threshold Voltage ( $V_{DS} = 10\text{ V}$ , $I_D = 50\text{ mA}$ )	$V_{GS(th)}$	2	2.5	5	Vdc
Drain–Source On–Voltage ( $V_{GS} = 10\text{ V}$ , $I_D = 1\text{ A}$ )	$V_{DS(on)}$	–	1.5	–	Vdc
Forward Transconductance ( $V_{DS} = 10\text{ V}$ , $I_D = 1\text{ A}$ )	$g_{fs}$	0.35	0.55	–	mhos

**DYNAMIC CHARACTERISTICS**

Input Capacitance ( $V_{DS} = 28\text{ V}$ , $V_{GS} = 0$ , $f = 1\text{ MHz}$ )	$C_{iss}$	–	15	–	pF
Output Capacitance ( $V_{DS} = 28\text{ V}$ , $V_{GS} = 0$ , $f = 1\text{ MHz}$ )	$C_{oss}$	–	9	–	pF
Reverse Transfer Capacitance ( $V_{DS} = 28\text{ V}$ , $V_{GS} = 0$ , $f = 1\text{ MHz}$ )	$C_{rss}$	–	0.7	–	pF

**FUNCTIONAL CHARACTERISTICS**

Common Source Power Gain ( $V_{DD} = 28\text{ Vdc}$ , $P_{out} = 10\text{ W}$ , $I_{DQ} = 50\text{ mA}$ , $f = 1.6\text{ GHz}$ )	$G_{ps}$	9.5	10.5	–	dB
Drain Efficiency ( $V_{DD} = 28\text{ Vdc}$ , $P_{out} = 10\text{ W}$ , $I_{DQ} = 50\text{ mA}$ , $f = 1.6\text{ GHz}$ )	$\eta$	45	50	–	%
Output Mismatch Stress ( $V_{DS} = 28\text{ Vdc}$ , $P_{out} = 10\text{ W}$ , $I_{DQ} = 50\text{ mA}$ , $f = 1600\text{ MHz}$ , Load VSWR 30:1 at All Phase Angles)	$\Psi$	No Degradation in Output Power			
Series Equivalent Input Impedance ( $V_{DD} = 28\text{ Vdc}$ , $P_{out} = 10\text{ W}$ , $I_{DQ} = 50\text{ mA}$ , $f = 1.6\text{ GHz}$ )	$Z_{in}$	–	$3.1 + j7.18$	–	$\Omega$
Series Equivalent Output Impedance ( $V_{DD} = 28\text{ Vdc}$ , $P_{out} = 10\text{ W}$ , $I_{DQ} = 50\text{ mA}$ , $f = 1.6\text{ GHz}$ )	$Z_{ol}$	–	$6.16 - j4.75$	–	$\Omega$

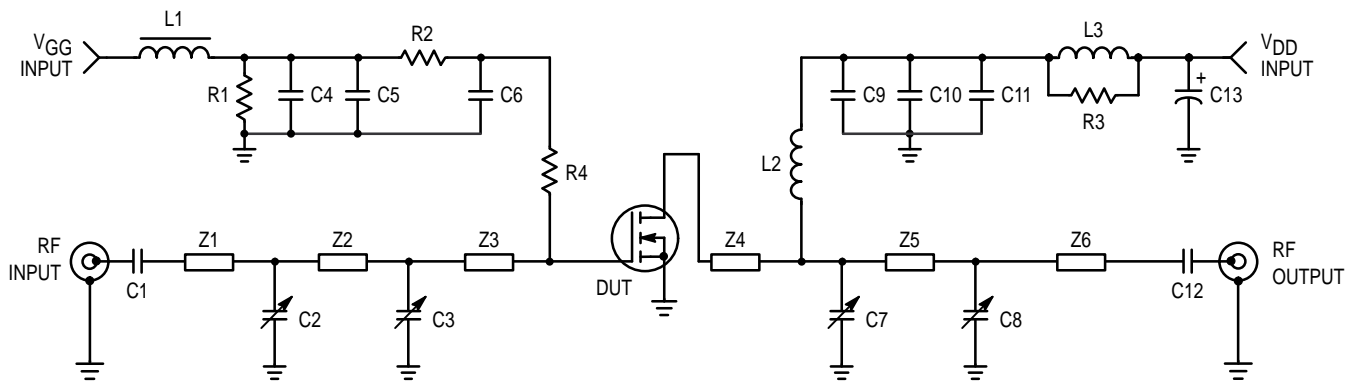

C1, C6, C10, C12	24 pF, "A" Chip Capacitor, ATC	R2	220 $\Omega$ , 1/4 W Resistor
C2, C3, C7, C8	0.8–8.0 pF, Variable Capacitor, Johansen Gigatrim	R3	10 k $\Omega$ , 2 W Resistor
C4, C11	240 pF, "A" Chip Capacitor, ATC	R4	10 k $\Omega$ , 1/8 W Resistor
C5, C9	0.1 $\mu\text{F}$ , Ceramic Capacitor	Z1	0.081" x 0.42" Microstrip
C13	50 $\mu\text{F}$ , 50 V, Electrolytic Capacitor	Z2	0.081" x 1.24" Microstrip
L1	Ferroxcube VK200–19/4B	Z3	0.32" x 0.48" Microstrip
L2	2 Turns, 0.175" ID, 20 AWG, Close Wound	Z4	0.35" x 0.5" Microstrip
L3	10 Turns, 20 AWG, Close Wound	Z5	0.15" x 0.44" Microstrip
R1	1 k $\Omega$ , 1/4 W Resistor	Z6	0.081" x 1.165" Microstrip

**Figure 1. 1.6 GHz Test Circuit Schematic**

## TYPICAL CHARACTERISTICS

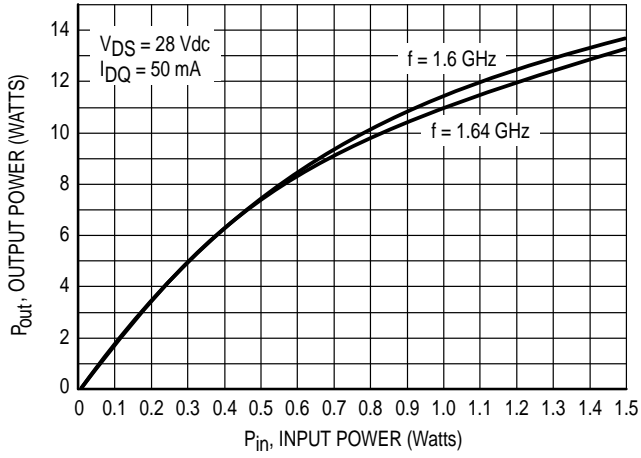

Figure 2. Output Power versus Input Power

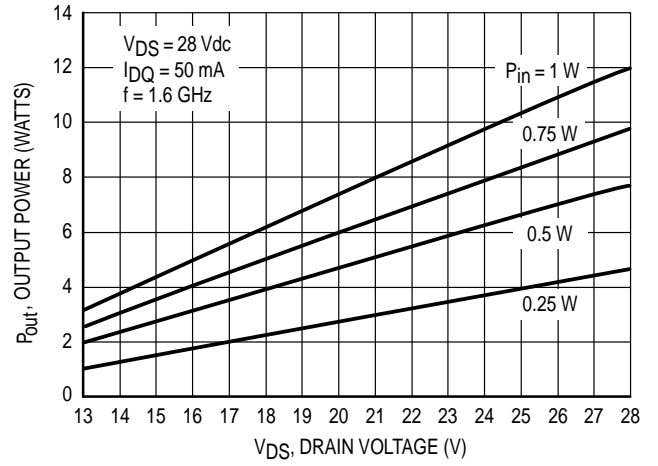

Figure 3. Output Power versus Drain Voltage

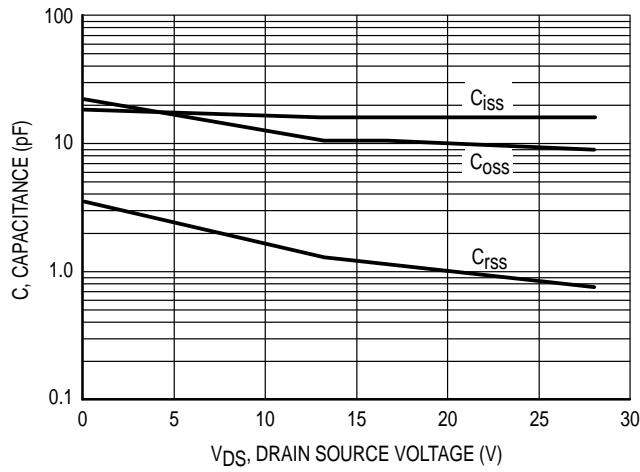

Figure 4. Capacitance versus Drain Voltage

f MHz	S <sub>11</sub>		S <sub>21</sub>		S <sub>12</sub>		S <sub>22</sub>	
	S <sub>11</sub>	∠φ	S <sub>21</sub>	∠φ	S <sub>12</sub>	∠φ	S <sub>22</sub>	∠φ
500	0.806	-164	4.98	54	0.026	-18	0.598	-125
510	0.805	-164	4.87	53	0.024	-18	0.604	-126
520	0.803	-165	4.75	52	0.024	-20	0.610	-127
530	0.805	-165	4.66	52	0.023	-20	0.619	-128
540	0.803	-166	4.55	51	0.023	-21	0.623	-128
550	0.806	-166	4.45	50	0.023	-22	0.628	-129
600	0.818	-169	4.00	45	0.021	-27	0.646	-132
650	0.822	-171	3.64	41	0.018	-20	0.663	-135
700	0.832	-174	3.35	38	0.017	-28	0.683	-138
750	0.838	-175	3.06	34	0.014	-32	0.704	-141
800	0.843	-178	2.84	30	0.012	-23	0.722	-143
820	0.847	-179	2.74	29	0.011	-21	0.724	-144
840	0.852	-179	2.67	27	0.008	-27	0.725	-145
860	0.855	180	2.59	26	0.009	-17	0.732	-146
880	0.858	179	2.52	25	0.006	-16	0.741	-147
900	0.859	179	2.46	24	0.004	-6	0.752	-147
920	0.860	178	2.39	22	0.006	24	0.758	-147
940	0.865	177	2.34	21	0.009	34	0.777	-148
960	0.874	176	2.29	19	0.011	25	0.790	-150
980	0.876	175	2.22	18	0.010	21	0.780	-152
1000	0.876	175	2.16	16	0.010	25	0.782	-152
1010	0.877	174	2.13	16	0.009	21	0.782	-153
1020	0.877	174	2.11	16	0.008	26	0.786	-153
1030	0.875	174	2.08	15	0.008	28	0.788	-153
1040	0.878	173	2.06	15	0.009	28	0.791	-153
1050	0.877	173	2.03	14	0.010	40	0.795	-154
1060	0.884	173	2.01	13	0.009	38	0.793	-154
1070	0.882	172	1.99	13	0.009	52	0.795	-154
1080	0.887	172	1.96	12	0.008	54	0.796	-155
1090	0.886	171	1.94	12	0.009	51	0.803	-155
1100	0.888	171	1.92	11	0.010	44	0.803	-156
1120	0.889	170	1.88	10	0.010	56	0.809	-156
1140	0.888	170	1.84	8	0.013	56	0.817	-157
1160	0.892	169	1.80	7	0.014	60	0.826	-157
1180	0.895	168	1.77	6	0.014	62	0.836	-158
1200	0.898	167	1.73	5	0.015	62	0.841	-159
1220	0.906	167	1.70	4	0.017	68	0.847	-160
1240	0.905	166	1.67	2	0.017	66	0.849	-161
1260	0.904	165	1.64	1	0.018	63	0.862	-162
1280	0.902	164	1.60	0	0.019	56	0.861	-163
1300	0.906	163	1.55	-1	0.021	55	0.867	-163

Table 1. Common Source S-Parameters ( $V_{DS} = 28\text{ V}$ ,  $I_D = 750\text{ mA}$ )

f MHz	S <sub>11</sub>		S <sub>21</sub>		S <sub>12</sub>		S <sub>22</sub>	
	S <sub>11</sub>	∠φ	S <sub>21</sub>	∠φ	S <sub>12</sub>	∠φ	S <sub>22</sub>	∠φ
1320	0.901	162	1.52	-2	0.018	49	0.866	-164
1340	0.906	162	1.49	-3	0.021	61	0.873	-165
1360	0.907	161	1.47	-4	0.022	61	0.875	-166
1380	0.905	161	1.44	-5	0.022	58	0.877	-167
1400	0.901	160	1.42	-7	0.021	58	0.881	-168
1420	0.900	159	1.39	-7	0.022	57	0.884	-168
1440	0.903	158	1.37	-9	0.022	58	0.885	-169
1460	0.912	158	1.34	-10	0.021	56	0.887	-170
1480	0.905	161	1.44	-5	0.022	58	0.877	-167
1500	0.910	156	1.30	-11	0.024	56	0.889	-171
1520	0.903	156	1.27	-12	0.023	57	0.891	-172
1540	0.899	155	1.26	-13	0.025	58	0.892	-173
1560	0.902	154	1.24	-15	0.026	56	0.893	-173
1570	0.902	153	1.22	-15	0.026	52	0.894	-174
1580	0.906	153	1.22	-16	0.024	53	0.892	-174
1590	0.906	153	1.21	-16	0.025	51	0.892	-174
1600	0.909	152	1.20	-17	0.026	49	0.892	-175
1610	0.911	152	1.20	-17	0.028	49	0.891	-175
1620	0.912	152	1.19	-17	0.026	53	0.889	-175
1630	0.907	151	1.18	-18	0.026	51	0.888	-176
1640	0.905	151	1.17	-18	0.027	55	0.889	-176
1650	0.895	150	1.16	-18	0.024	53	0.889	-177
1660	0.893	150	1.15	-19	0.027	52	0.889	-177
1670	0.890	150	1.14	-19	0.027	53	0.891	-177
1680	0.894	149	1.13	-20	0.026	51	0.891	-178
1690	0.899	148	1.12	-20	0.027	49	0.889	-178
1700	0.899	148	1.12	-21	0.027	53	0.888	-178
1750	0.905	147	1.09	-24	0.028	51	0.881	-180
1800	0.887	144	1.06	-26	0.029	50	0.889	179
1850	0.893	142	1.03	-28	0.029	50	0.885	178
1900	0.888	141	1.00	-31	0.031	51	0.883	176
1950	0.883	138	0.99	-34	0.032	51	0.888	176
2000	0.887	135	0.97	-36	0.032	44	0.887	174
2050	0.875	134	0.94	-38	0.035	46	0.894	173
2100	0.885	130	0.93	-42	0.037	45	0.894	172
2150	0.882	128	0.93	-45	0.038	37	0.905	170
2200	0.865	125	0.91	-47	0.040	37	0.907	169
2250	0.875	121	0.90	-50	0.040	30	0.911	168
2300	0.864	118	0.89	-54	0.037	27	0.915	165
2350	0.857	114	0.88	-56	0.042	31	0.917	163
2400	0.849	111	0.87	-59	0.042	23	0.906	162
2500	0.841	102	0.86	-66	0.040	13	0.887	160

Table 1. Common Source S-Parameters ( $V_{DS} = 28\text{ V}$ ,  $I_D = 750\text{ mA}$ ) (continued)

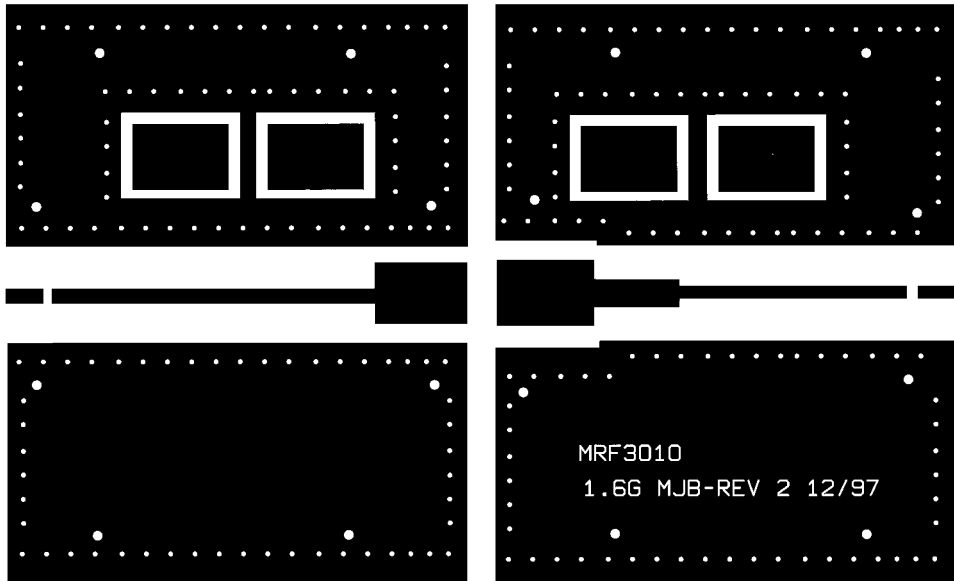

(Scale 1:1)

**Figure 5. Photomaster for MRF3010**  
(Reduced 25% in printed data book, DL110/D)

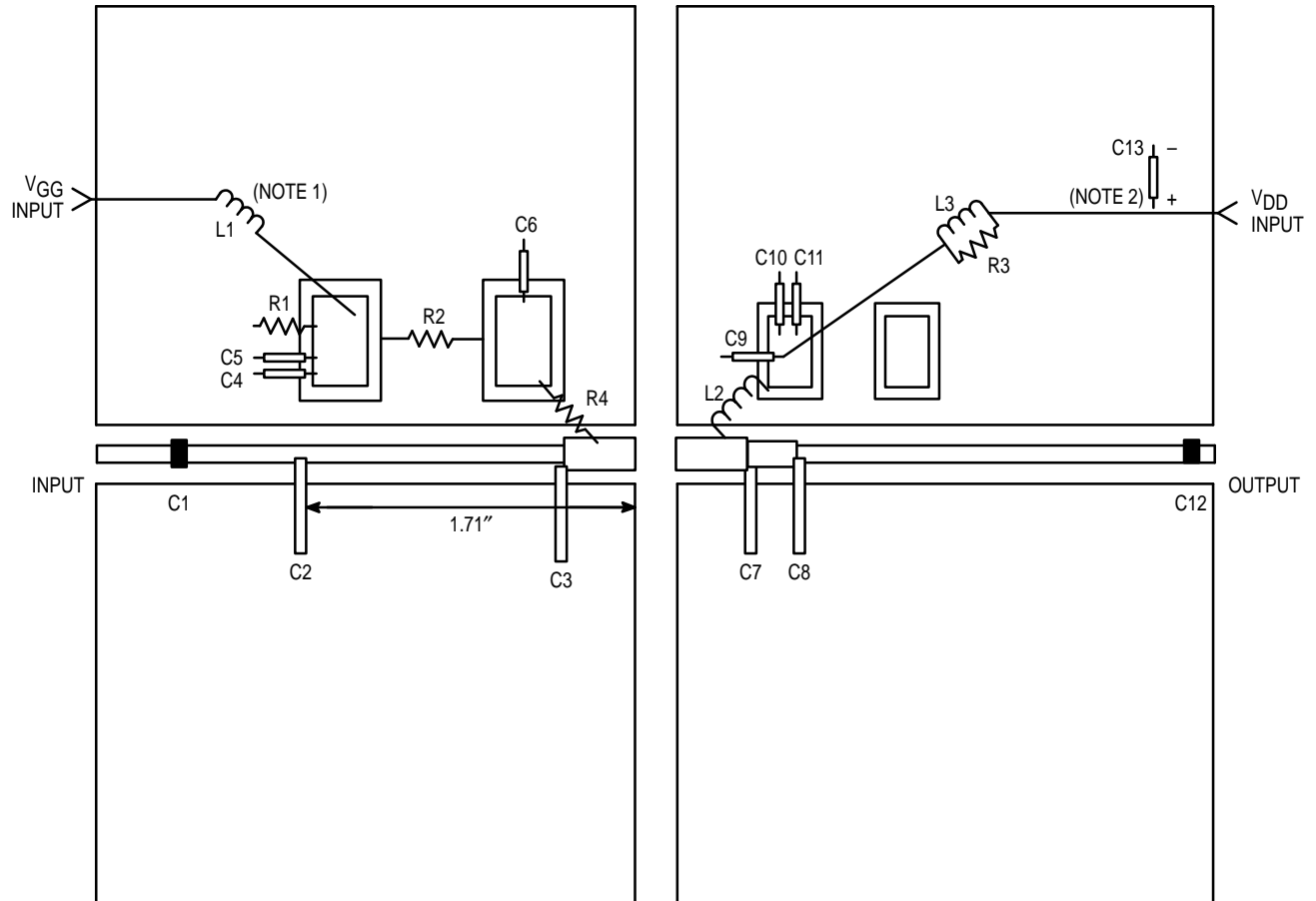

- C1, C6, C10, C12 24 pF, "A" Chip Capacitor, ATC
- C2, C3, C7, C8 0.8–8.0 pF, Variable Capacitor, Johansen Gigatrim
- C4, C11 240 pF, "A" Chip Capacitor, ATC
- C5, C9 0.1  $\mu$ F, Ceramic Capacitor
- C13 50  $\mu$ F, 50 V, Electrolytic Capacitor
- L1 VK200
- L2 2 Turns, 0.175" ID, 20 AWG, Close Wound
- L3 10 Turns, 20 AWG, Close Wound

- R1 1 k $\Omega$ , 1/4 W Resistor
- R2 220  $\Omega$ , 1/4 W Resistor
- R3 10 k $\Omega$ , 2 W Resistor
- R4 10 k $\Omega$ , 1/8 W Resistor

- NOTES:
- (1) L1 is gate input from Endplate
  - (2) L3 is wrapped around R3

**Figure 6. 1.6 GHz Test Circuit Layout**

## PACKAGE DIMENSIONS

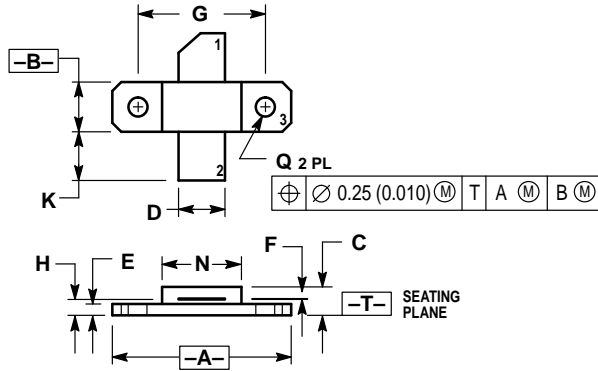

- NOTES:  
 1. DIMENSIONING AND TOLERANCING PER ANSI Y14.5M, 1982.  
 2. CONTROLLING DIMENSION: INCH.

DIM	INCHES		MILLIMETERS	
	MIN	MAX	MIN	MAX
A	0.790	0.810	20.07	20.57
B	0.220	0.240	5.59	6.09
C	0.125	0.175	3.18	4.45
D	0.205	0.225	5.21	5.71
E	0.050	0.070	1.27	1.77
F	0.004	0.006	0.11	0.15
G	0.562 BSC		14.27 BSC	
H	0.070	0.090	1.78	2.29
K	0.215	0.255	5.47	6.47
N	0.350	0.370	8.89	9.39
Q	0.120	0.140	3.05	3.55

- STYLE 1:  
 PIN 1. DRAIN  
 2. GATE  
 3. SOURCE

### CASE 360B-01 ISSUE O

Motorola reserves the right to make changes without further notice to any products herein. Motorola makes no warranty, representation or guarantee regarding the suitability of its products for any particular purpose, nor does Motorola assume any liability arising out of the application or use of any product or circuit, and specifically disclaims any and all liability, including without limitation consequential or incidental damages. "Typical" parameters which may be provided in Motorola data sheets and/or specifications can and do vary in different applications and actual performance may vary over time. All operating parameters, including "Typicals" must be validated for each customer application by customer's technical experts. Motorola does not convey any license under its patent rights nor the rights of others. Motorola products are not designed, intended, or authorized for use as components in systems intended for surgical implant into the body, or other applications intended to support or sustain life, or for any other application in which the failure of the Motorola product could create a situation where personal injury or death may occur. Should Buyer purchase or use Motorola products for any such unintended or unauthorized application, Buyer shall indemnify and hold Motorola and its officers, employees, subsidiaries, affiliates, and distributors harmless against all claims, costs, damages, and expenses, and reasonable attorney fees arising out of, directly or indirectly, any claim of personal injury or death associated with such unintended or unauthorized use, even if such claim alleges that Motorola was negligent regarding the design or manufacture of the part. Motorola and  are registered trademarks of Motorola, Inc. Motorola, Inc. is an Equal Opportunity/Affirmative Action Employer.

Mfax is a trademark of Motorola, Inc.

#### How to reach us:

**USA/EUROPE/Locations Not Listed:** Motorola Literature Distribution;  
 P.O. Box 5405, Denver, Colorado 80217. 1-303-675-2140 or 1-800-441-2447

**JAPAN:** Nippon Motorola Ltd.: SPD, Strategic Planning Office, 141,  
 4-32-1 Nishi-Gotanda, Shagawa-ku, Tokyo, Japan. 03-5487-8488

**Customer Focus Center: 1-800-521-6274**

**Mfax™:** RMFAX0@email.sps.mot.com – TOUCHTONE 1-602-244-6609  
 Motorola Fax Back System – US & Canada ONLY 1-800-774-1848  
 – <http://sps.motorola.com/mfax/>

**ASIA/PACIFIC:** Motorola Semiconductors H.K. Ltd.; 8B Tai Ping Industrial Park,  
 51 Ting Kok Road, Tai Po, N.T., Hong Kong. 852-26629298

**HOME PAGE:** <http://motorola.com/sps/>