

Cascadable Silicon Bipolar MMIC Amplifiers

Technical Data

MSA-0135, -0136

Features

- **Cascadable 50 Ω Gain Block**
- **3 dB Bandwidth:**
DC to 1.2 GHz
- **High Gain:**
18.5 dB Typical at 0.5 GHz
- **Unconditionally Stable**
($k > 1$)
- **Cost Effective Ceramic Microstrip Package**

Description

The MSA-0135 is a high performance silicon bipolar Monolithic Microwave Integrated Circuit (MMIC) housed in a cost effective, microstrip package. This MMIC is designed for use as a general

purpose 50 Ω gain block. Typical applications include narrow and broad band IF and RF amplifiers in industrial and military applications.

The MSA-series is fabricated using HP's 10 GHz f_T , 25 GHz f_{MAX} , silicon bipolar MMIC process which uses nitride self-alignment, ion implantation, and gold metallization to achieve excellent performance, uniformity and reliability. The use of an external bias resistor for temperature and current stability also allows bias flexibility.

Available in cut lead version (package 36) as MSA-0136.

35 micro-X Package^[1]

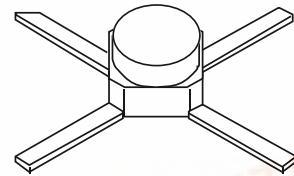

Note:

1. Short leaded 36 package available upon request.

Typical Biasing Configuration

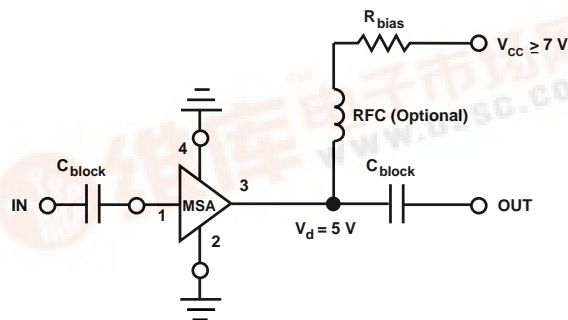

MSA-0135, -0136 Absolute Maximum Ratings

Parameter	Absolute Maximum ^[1]
Device Current	40 mA
Power Dissipation ^[2,3]	200 mW
RF Input Power	+13 dBm
Junction Temperature	200°C
Storage Temperature	-65 to 200°C

Thermal Resistance^[2,5]:

$$\theta_{jc} = 150^{\circ}\text{C/W}$$

Notes:

1. Permanent damage may occur if any of these limits are exceeded.
2. $T_{\text{CASE}} = 25^{\circ}\text{C}$.
3. Derate at 6.7 mW/°C for $T_{\text{C}} > 170^{\circ}\text{C}$.
4. Storage above +150°C may tarnish the leads of this package making it difficult to solder into a circuit.
5. The small spot size of this technique results in a higher, though more accurate determination of θ_{jc} than do alternate methods. See MEASUREMENTS section “Thermal Resistance” for more information.

MSA-0135, -0136 Electrical Specifications^[1], $T_{\text{A}} = 25^{\circ}\text{C}$

Symbol	Parameters and Test Conditions: $I_{\text{d}} = 17 \text{ mA}$, $Z_{\text{O}} = 50 \Omega$	Units	Min.	Typ.	Max.
G_{P}	Power Gain ($ S_{21} ^2$) $f = 0.1 \text{ GHz}$	dB	18.0	19.0	
ΔG_{P}	Gain Flatness $f = 0.1 \text{ to } 0.6 \text{ GHz}$	dB		± 0.6	
$f_{3 \text{ dB}}$	3 dB Bandwidth	GHz		1.2	
VSWR	Input VSWR $f = 0.1 \text{ to } 3.0 \text{ GHz}$			1.3:1	
	Output VSWR $f = 0.1 \text{ to } 3.0 \text{ GHz}$			1.3:1	
NF	50 Ω Noise Figure $f = 0.5 \text{ GHz}$	dB		5.5	
$P_{1 \text{ dB}}$	Output Power at 1 dB Gain Compression $f = 0.5 \text{ GHz}$	dBm		1.5	
IP_3	Third Order Intercept Point $f = 0.5 \text{ GHz}$	dBm		14.0	
t_{D}	Group Delay $f = 0.5 \text{ GHz}$	psec		160	
V_{d}	Device Voltage	V	4.5	5.0	5.5
dV/dT	Device Voltage Temperature Coefficient	mV/°C		-9.0	

Notes:

1. The recommended operating current range for this device is 13 to 25 mA. Typical performance as a function of current is on the following page.

MSA-0135, -0136 Typical Scattering Parameters ($Z_0 = 50 \Omega$, $T_A = 25^\circ\text{C}$, $I_d = 17 \text{ mA}$)

Freq. GHz	S ₁₁		S ₂₁			S ₁₂			S ₂₂	
	Mag	Ang	dB	Mag	Ang	dB	Mag	Ang	Mag	Ang
0.1	.08	158	19.1	9.01	172	-23.0	.071	3	.07	-2
0.2	.08	134	18.9	8.84	165	-22.4	.076	6	.07	-10
0.3	.08	116	18.7	8.65	157	-22.5	.075	12	.07	-10
0.4	.08	97	18.5	8.40	150	-22.2	.078	13	.07	-15
0.5	.09	83	18.2	8.13	143	-21.7	.082	16	.07	-17
0.6	.09	68	17.9	7.84	136	-21.6	.083	17	.07	-21
0.8	.11	47	17.2	7.25	125	-20.7	.092	22	.07	-30
1.0	.11	27	16.5	6.64	113	-19.9	.101	23	.07	-34
1.5	.11	-18	14.6	5.37	90	-18.3	.122	27	.06	-34
2.0	.09	-62	12.8	4.38	70	-16.8	.144	24	.05	-39
2.5	.08	-114	11.3	3.67	58	-16.1	.157	24	.03	-61
3.0	.12	-158	10.0	3.15	43	-15.0	.177	20	.03	-67
3.5	.18	178	8.7	2.72	28	-14.5	.189	14	.05	-88
4.0	.21	163	7.5	2.37	15	-14.0	.200	9	.10	-92
4.5	.23	145	6.4	2.10	2	-13.4	.213	4	.14	-99
5.0	.27	125	5.5	1.88	-10	-13.2	.220	-2	.15	-102

A model for this device is available in the DEVICE MODELS section.

MSA-0135, -0136 Typical Performance, $T_A = 25^\circ\text{C}$

(unless otherwise noted)

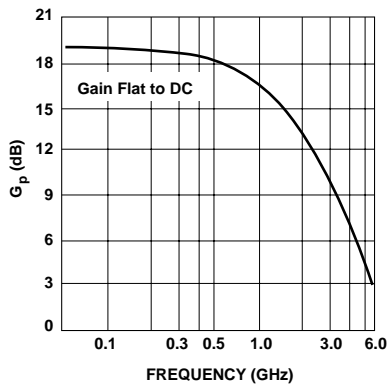

Figure 1. Typical Power Gain vs. Frequency, $T_A = 25^\circ\text{C}$, $I_d = 17 \text{ mA}$.

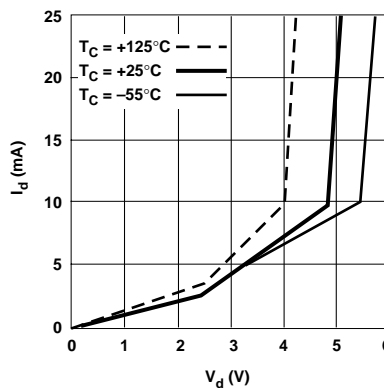

Figure 2. Device Current vs. Voltage.

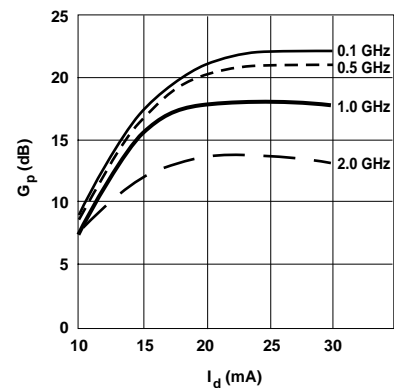

Figure 3. Power Gain vs. Current.

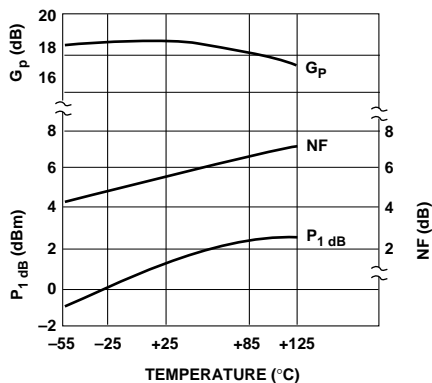

Figure 4. Output Power at 1 dB Gain Compression, NF and Power Gain vs. Temperature, $f = 0.5 \text{ GHz}$, $I_d = 17 \text{ mA}$

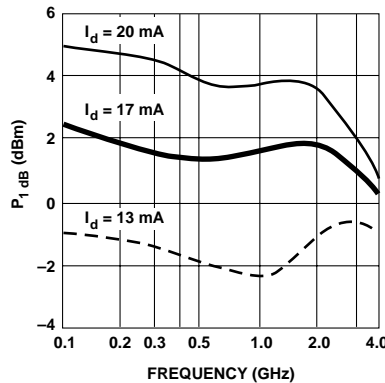

Figure 5. Output Power at 1 dB Gain Compression vs. Frequency.

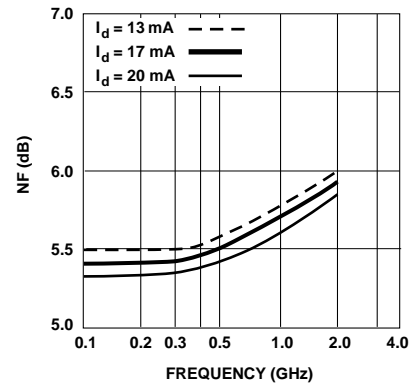

Figure 6. Noise Figure vs. Frequency.

35 micro-X Package Dimensions

