

Cascadable Silicon Bipolar MMIC Amplifier

Technical Data

MSA-0170

Features

- **Cascadable 50 Ω Gain Block**
- **3 dB Bandwidth:**
DC to 1.3 GHz
- **High Gain:**
18.5 dB Typical at 0.5 GHz
- **Unconditionally Stable**
($k > 1$)
- **Hermetic Gold-ceramic
Microstrip Package**

Description

The MSA-0170 is a high performance silicon bipolar Monolithic Microwave Integrated Circuit (MMIC) housed in a hermetic high reliability package. This MMIC is

designed for use as a general purpose 50 Ω gain block. Typical applications include narrow and broad band IF and RF amplifiers in industrial and military applications.

The MSA-series is fabricated using HP's 10 GHz f_T , 25 GHz f_{MAX} , silicon bipolar MMIC process which uses nitride self-alignment, ion implantation, and gold metallization to achieve excellent performance, uniformity and reliability. The use of an external bias resistor for temperature and current stability also allows bias flexibility.

70 mil Package

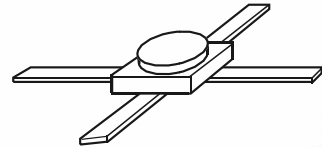

Typical Biasing Configuration

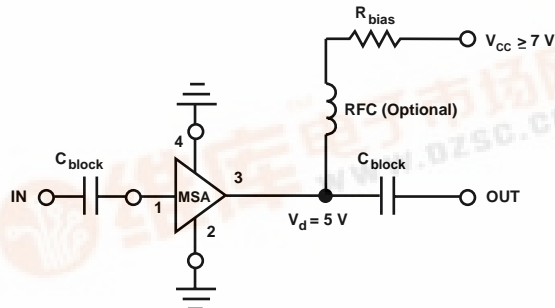

MSA-0170 Absolute Maximum Ratings

Parameter	Absolute Maximum ^[1]
Device Current	40 mA
Power Dissipation ^[2,3]	200 mW
RF Input Power	+13 dBm
Junction Temperature	200°C
Storage Temperature	-65 to 200°C

Thermal Resistance^[2,4]:

$$\theta_{jc} = 125^{\circ}\text{C}/\text{W}$$

Notes:

1. Permanent damage may occur if any of these limits are exceeded.
2. $T_{\text{CASE}} = 25^{\circ}\text{C}$.
3. Derate at 8 mW/°C for $T_{\text{C}} > 175^{\circ}\text{C}$.
4. The small spot size of this technique results in a higher, though more accurate determination of θ_{jc} than do alternate methods. See MEASUREMENTS section "Thermal Resistance" for more information.

MSA-0170 Electrical Specifications^[1], $T_{\text{A}} = 25^{\circ}\text{C}$

Symbol	Parameters and Test Conditions: $I_{\text{d}} = 17 \text{ mA}$, $Z_{\text{o}} = 50 \Omega$	Units	Min.	Typ.	Max.	
GP	Power Gain ($ S_{21} ^2$)	f = 0.1 GHz	dB	18.0	19.0	
ΔGP	Gain Flatness	f = 0.1 to 0.7 GHz	dB		± 0.6	
$f_{3 \text{ dB}}$	3 dB Bandwidth		GHz		1.3	
VSWR	Input VSWR	f = 0.1 to 3.0 GHz			1.3:1	
	Output VSWR	f = 0.1 to 3.0 GHz			1.3:1	
NF	50 Ω Noise Figure	f = 0.5 GHz	dB		5.5	
$P_{1 \text{ dB}}$	Output Power at 1 dB Gain Compression	f = 0.5 GHz	dBm		1.5	
IP_3	Third Order Intercept Point	f = 0.5 GHz	dBm		14.0	
t_{D}	Group Delay	f = 0.5 GHz	psec		150	
V_{d}	Device Voltage		V	4.5	5.0	5.5
dV/dT	Device Voltage Temperature Coefficient		mV/°C		-9.0	

Note:

1. The recommended operating current range for this device is 13 to 25 mA. Typical performance as a function of current is on the following page.

MSA-0170 Typical Scattering Parameters ($Z_0 = 50 \Omega$, $T_A = 25^\circ\text{C}$, $I_d = 17 \text{ mA}$)

Freq. GHz	S ₁₁		S ₂₁			S ₁₂			S ₂₂	
	Mag	Ang	dB	Mag	Ang	dB	Mag	Ang	Mag	Ang
0.1	.08	171	19.0	8.88	173	-22.7	.073	2	.10	-13
0.2	.07	161	18.9	8.77	167	-22.5	.075	6	.11	-27
0.3	.07	152	18.7	8.64	160	-22.3	.077	8	.10	-39
0.4	.06	143	18.5	8.45	153	-22.4	.076	11	.11	-49
0.5	.05	133	18.3	8.23	147	-22.0	.079	13	.11	-59
0.6	.04	115	18.0	7.98	141	-21.8	.081	17	.12	-67
0.8	.03	79	17.5	7.46	130	-21.2	.087	20	.12	-83
1.0	.04	-14	16.8	6.90	119	-20.2	.098	23	.12	-96
1.5	.08	-52	15.0	5.64	96	-19.0	.112	26	.10	-116
2.0	.12	-87	13.2	4.58	78	-17.7	.131	24	.08	-134
2.5	.15	-112	11.7	3.85	67	-16.7	.147	25	.07	-135
3.0	.19	-132	10.3	3.27	54	-16.1	.156	22	.07	-129
3.5	.24	-148	8.9	2.80	41	-15.4	.170	18	.09	-117
4.0	.26	-159	7.7	2.43	29	-15.0	.177	13	.13	-106
4.5	.27	-170	6.6	2.14	18	-14.7	.184	8	.17	-105
5.0	.27	175	5.7	1.92	8	-14.3	.192	5	.20	-106

A model for this device is available in the DEVICE MODELS section.

MSA-0170 Typical Performance, $T_A = 25^\circ\text{C}$

(unless otherwise noted)

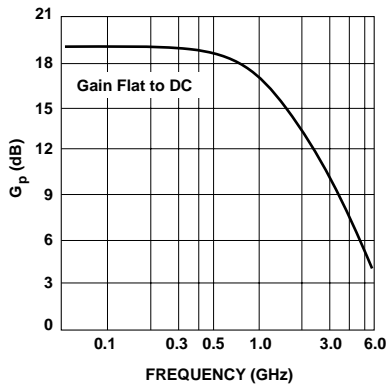

Figure 1. Typical Power Gain vs. Frequency, $T_A = 25^\circ\text{C}$, $I_d = 17 \text{ mA}$.

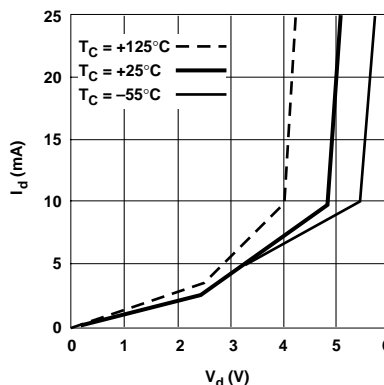

Figure 2. Device Current vs. Voltage.

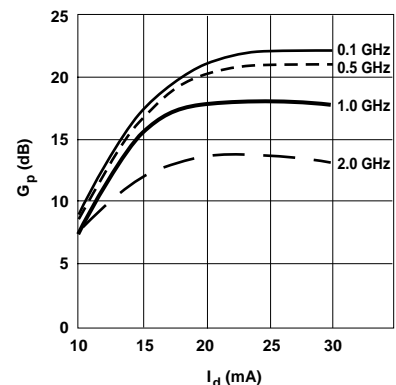

Figure 3. Power Gain vs. Current.

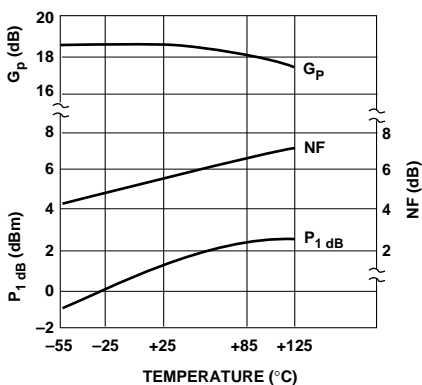

Figure 4. Output Power at 1 dB Gain Compression, NF and Power Gain vs. Case Temperature. $f = 0.5 \text{ GHz}$, $I_d = 17 \text{ mA}$.

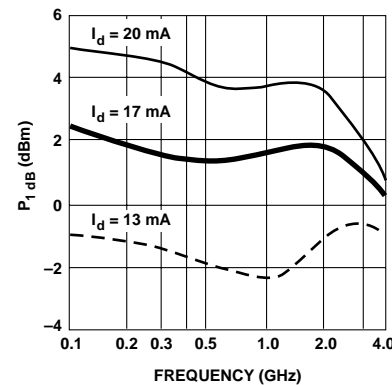

Figure 5. Output Power at 1 dB Gain Compression vs. Frequency.

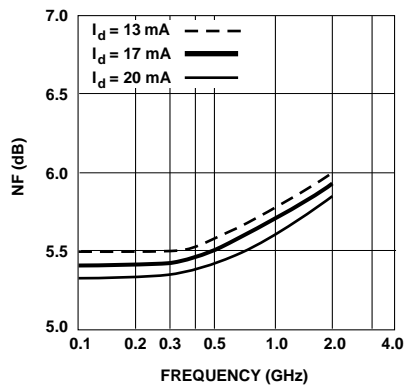

Figure 6. Noise Figure vs. Frequency.

70 mil Package Dimensions

