

**MOTOROLA**  
**SEMICONDUCTOR**  
TECHNICAL DATA

*Designer's Data Sheet*  
**Power Field Effect Transistor**  
**N-Channel Enhancement-Mode**  
**Silicon Gate**

This TMOS Power FET is designed for high voltage, high speed power switching applications such as switching regulators, converters, solenoid and relay drivers.

- Silicon Gate for Fast Switching Speeds — Switching Times Specified at 100°C
- Designer's Data —  $I_{DSS}$ ,  $V_{DS(on)}$ ,  $V_{GS(th)}$  and SOA Specified at Elevated Temperature
- Rugged — SOA is Power Dissipation Limited
- Source-to-Drain Diode Characterized for Use With Inductive Loads

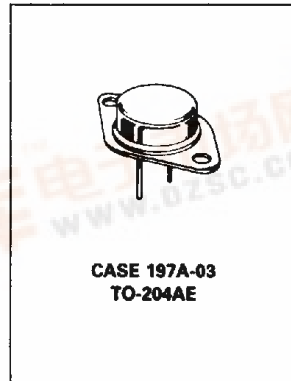
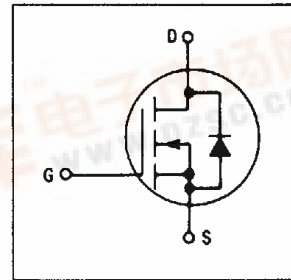
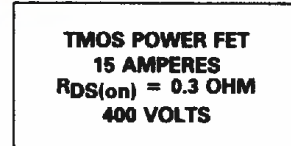
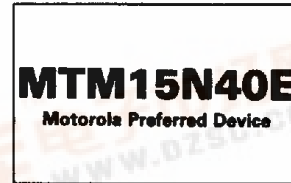

**MAXIMUM RATINGS**

| Rating                                       | Symbol         | Value      | Unit  |
|--|----------------|------------|-------|
| Drain-Source Voltage                         | $V_{DS}$       | 400        | Vdc   |
| Drain-Gate Voltage ( $R_{GS} = 1 M\Omega$ )  | $V_{DGR}$      | 400        | Vdc   |
| Gate-Source Voltage — Continuous             | $V_{GS}$       | $\pm 20$   | Vdc   |
| — Non-repetitive ( $t_p \leq 50 \mu s$ )     | $V_{GSM}$      | $\pm 40$   | Vpk   |
| Drain Current — Continuous                   | $I_D$          | 15         | Adc   |
| — Pulsed                                     | $I_{DM}$       | 70         |       |
| Total Power Dissipation @ $T_C = 25^\circ C$ | $P_D$          | 250        | Watts |
| Derate above $25^\circ C$                    |                | 2          | W/°C  |
| Operating and Storage Temperature Range      | $T_J, T_{stg}$ | -65 to 150 | °C    |

**THERMAL CHARACTERISTICS**

|   |                 |     |      |
|---|-----------------|-----|------|
| Thermal Resistance — Junction to Case   | $R_{\theta JC}$ | 0.5 | °C/W |
| — Junction to Ambient   | $R_{\theta JA}$ | 30  |      |
| Maximum Lead Temperature for Soldering Purposes, 1/8" from case for 5 seconds | $T_L$           | 300 | °C   |

Designer's Data for "Worst Case" Conditions — The Designer's Data Sheet permits the design of most circuits entirely from the information presented. SOA Limit curves — representing boundaries on device characteristics — are given to facilitate "worst case" design

Preferred device is a Motorola recommended choice for future use and best overall value.



MTM15N40E

MOTOROLA SC (XSTRS/R F)

68E D

6367254 0098594 979

MOT6

**ELECTRICAL CHARACTERISTICS** ( $T_C = 25^\circ\text{C}$  unless otherwise noted)

| Characteristic | Symbol | Min | Max | Unit |
|----------------|--------|-----|-----|------|
|----------------|--------|-----|-----|------|

**OFF CHARACTERISTICS**

|   |               |     |          |      |
|---|---------------|-----|----------|------|
| Drain-Source Breakdown Voltage<br>( $V_{GS} = 0, I_D = 0.25 \text{ mA}$ )   | $V_{(BR)DSS}$ | 400 | —        | Vdc  |
| Zero Gate Voltage Drain Current<br>( $V_{DS} = \text{Rated } V_{DSS}, V_{GS} = 0$ )<br>( $V_{DS} = 0.8 \text{ Rated } V_{DSS}, V_{GS} = 0, T_J = 125^\circ\text{C}$ ) | $I_{DSS}$     | —   | 0.2<br>1 | mAdc |
| Gate-Body Leakage Current, Forward ( $V_{GSF} = 20 \text{ Vdc}, V_{DS} = 0$ )   | $I_{GSSF}$    | —   | 100      | nAdc |
| Gate-Body Leakage Current, Reverse ( $V_{GSR} = 20 \text{ Vdc}, V_{DS} = 0$ )   | $I_{GSSR}$    | —   | 100      | nAdc |

**ON CHARACTERISTICS\***

|   |              |          |          |      |
|---|--------------|----------|----------|------|
| Gate Threshold Voltage<br>( $V_{DS} = V_{GS}, I_D = 1 \text{ mA}$ )<br>$T_J = 100^\circ\text{C}$  | $V_{GS(th)}$ | 2<br>1.5 | 4.5<br>4 | Vdc  |
| Static Drain-Source On-Resistance ( $V_{GS} = 10 \text{ Vdc}, I_D = 7.5 \text{ Adc}$ )  | $R_{DS(on)}$ | —        | 0.3      | Ohm  |
| Drain-Source On-Voltage ( $V_{GS} = 10 \text{ V}$ )<br>( $I_D = 15 \text{ Adc}$ )<br>( $I_D = 7.5 \text{ Adc}, T_J = 100^\circ\text{C}$ ) | $V_{DS(on)}$ | —        | —        | Vdc  |
| Forward Transconductance ( $V_{DS} = 15 \text{ V}, I_D = 7.5 \text{ A}$ )   | $g_{FS}$     | 6        | —        | mhos |

**DYNAMIC CHARACTERISTICS**

|                              |  |           |   |      |    |
|------------------------------|--|-----------|---|------|----|
| Input Capacitance            | $(V_{DS} = 25 \text{ V}, V_{GS} = 0,$<br>$f = 1 \text{ MHz})$<br>See Figure 11 | $C_{iss}$ | — | 3000 | pF |
| Output Capacitance           |  | $C_{oss}$ | — | 500  |    |
| Reverse Transfer Capacitance |  | $C_{rss}$ | — | 200  |    |

**SWITCHING CHARACTERISTICS\* ( $T_J = 100^\circ\text{C}$ )**

|                     |  |              |           |     |    |
|---------------------|--|--------------|-----------|-----|----|
| Turn-On Delay Time  | $(V_{DD} = 25 \text{ V}, I_D = 0.5 \text{ Rated } I_D$<br>$R_{gen} = 50 \text{ ohms})$<br>See Figures 9, 13 and 14 | $t_{d(on)}$  | —         | 60  | ns |
| Rise Time           |  | $t_r$        | —         | 180 |    |
| Turn-Off Delay Time |  | $t_{d(off)}$ | —         | 450 |    |
| Fall Time           |  | $t_f$        | —         | 180 |    |
| Total Gate Charge   | $(V_{DS} = 0.8 \text{ Rated } V_{DSS},$<br>$I_D = \text{Rated } I_D, V_{GS} = 10 \text{ V})$<br>See Figure 12      | $Q_g$        | 110 (Typ) | 160 | nC |
| Gate-Source Charge  |  | $Q_{gs}$     | 50 (Typ)  | —   |    |
| Gate-Drain Charge   |  | $Q_{gd}$     | 60 (Typ)  | —   |    |

**SOURCE DRAIN DIODE CHARACTERISTICS\***

|                       |   |          |                             |     |     |
|-----------------------|---|----------|-----------------------------|-----|-----|
| Forward On-Voltage    | $(I_S = \text{Rated } I_D$<br>$V_{GS} = 0)$ | $V_{SD}$ | 1.3 (Typ)                   | 1.6 | Vdc |
| Forward Turn-On Time  |   | $t_{on}$ | Limited by stray inductance |     |     |
| Reverse Recovery Time |   | $t_{rr}$ | 1200 (Typ)                  | —   | ns  |

**INTERNAL PACKAGE INDUCTANCE**

|   |       |            |   |    |
|---|-------|------------|---|----|
| Internal Drain Inductance<br>(Measured from the contact screw on the header closer to the source pin and the center of the die) | $L_d$ | 5 (Typ)    | — | nH |
| Internal Source Inductance<br>(Measured from the source pin, 0.25" from the package to the source bond pad)                     | $L_s$ | 12.5 (Typ) | — | nH |

\*Pulse Test Pulse Width  $\leq 300 \mu\text{s}$ , Duty Cycle  $\leq 2\%$ .

MTM15N40E

MOTOROLA 3C (XSTRS/R F) 68E D 6367254 0098595 805 MOT6  
 TYPICAL ELECTRICAL CHARACTERISTICS

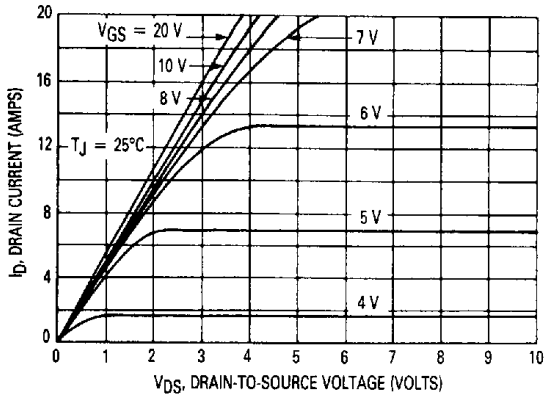

Figure 1. On-Region Characteristics

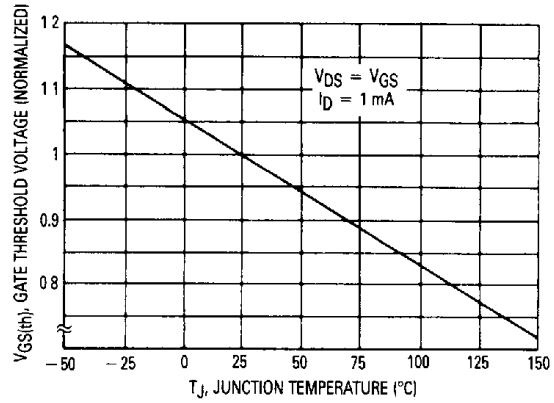

Figure 2. Gate-Threshold Voltage Variation With Temperature

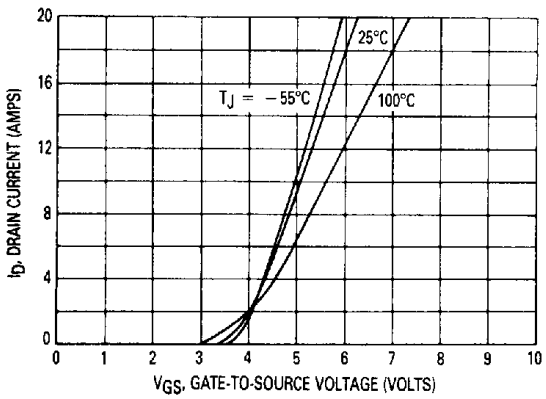

Figure 3. Transfer Characteristics

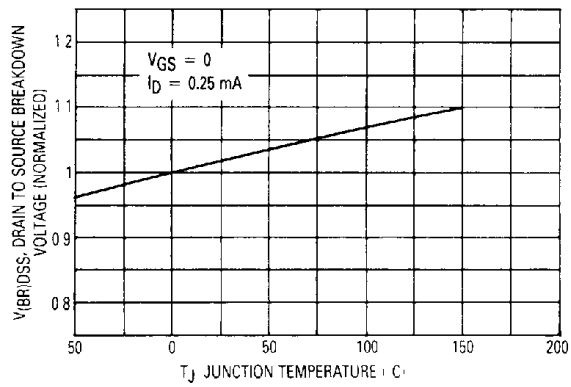

Figure 4. Breakdown Voltage Variation With Temperature

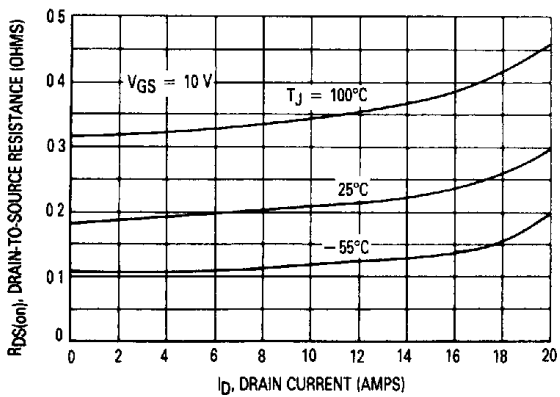

Figure 5. On-Resistance versus Drain Current

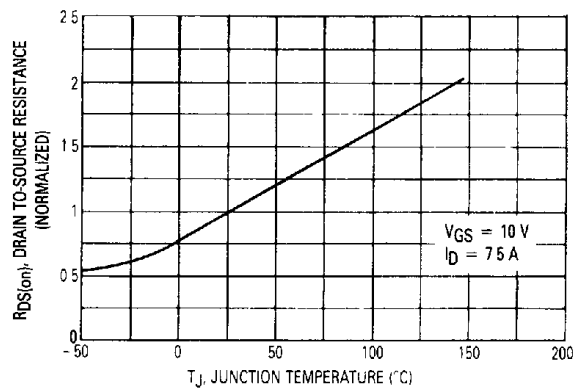

Figure 6. On-Resistance Variation With Temperature

SAFE OPERATING AREA INFORMATION

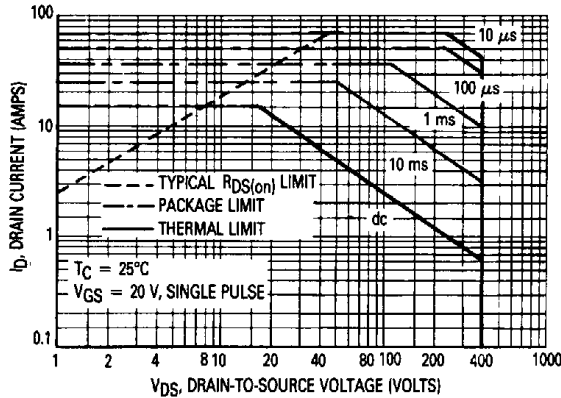

Figure 7. Maximum Rated Forward Biased Safe Operating Area

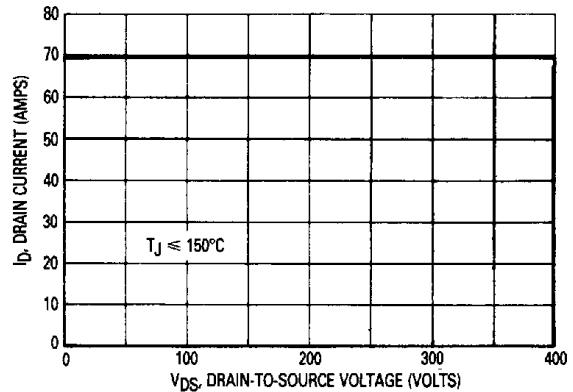

Figure 8. Maximum Rated Switching Safe Operating Area

3

FORWARD BIASED SAFE OPERATING AREA

The FBSOA curves define the maximum drain-to-source voltage and drain current that a device can safely handle when it is forward biased, or when it is on, or being turned on. Because these curves include the limitations of simultaneous high voltage and high current, up to the rating of the device, they are especially useful to designers of linear systems. The curves are based on a case temperature of 25°C and a maximum junction temperature of 150°C. Limitations for repetitive pulses at various case temperatures can be determined by using the thermal response curves. Motorola Application Note, AN569, "Transient Thermal Resistance-General Data and Its Use" provides detailed instructions.

SWITCHING SAFE OPERATING AREA

The switching safe operating area (SOA) of Figure 8 is the boundary that the load line may traverse without incurring damage to the MOSFET. The fundamental limits are the peak current,  $I_{DM}$  and the breakdown voltage,  $V(BR)_{DSS}$ . The switching SOA shown in Figure 8 is applicable for both turn-on and turn-off of the devices for switching times less than one microsecond.

The power averaged over a complete switching cycle must be less than:

$$\frac{T_{J(max)} - T_C}{R_{\theta JC}}$$

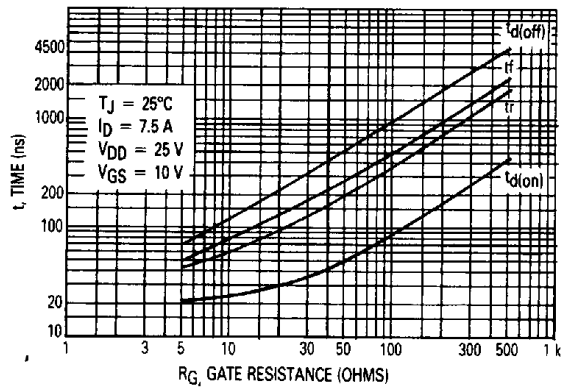

Figure 9. Resistive Switching Time Variation With Gate Resistance

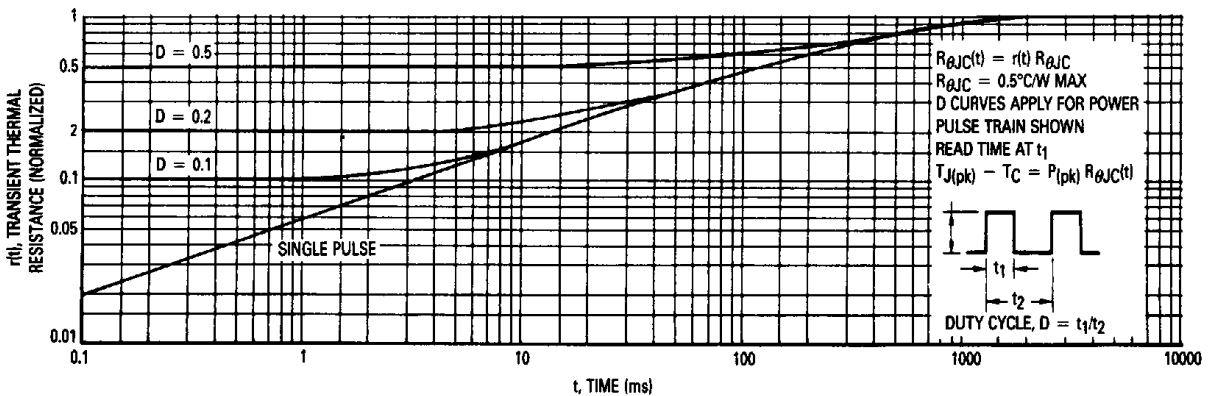

Figure 10. Thermal Response

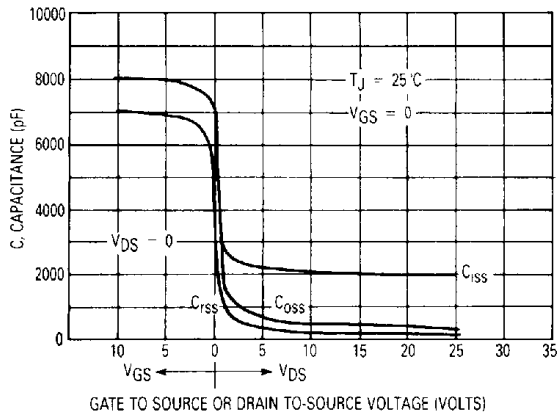

Figure 11. Capacitance Variation

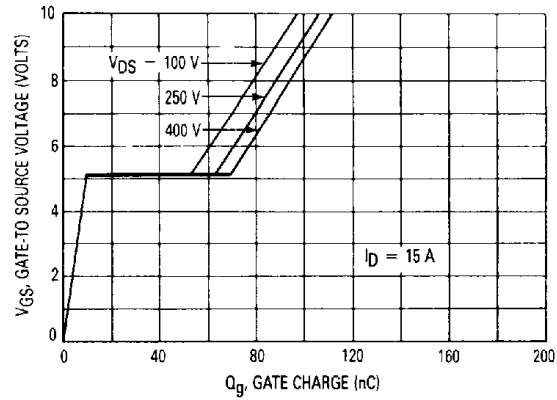

Figure 12. Gate Charge versus Gate-to-Source Voltage

RESISTIVE SWITCHING

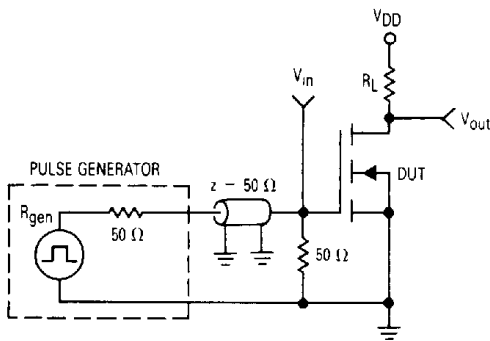

Figure 13. Switching Test Circuit

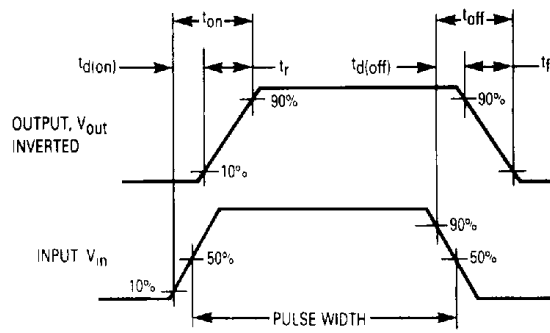

Figure 14. Switching Waveforms