

Designer's™ Data Sheet

TMOS E-FET™

Power Field Effect Transistor

TO-247 with Isolated Mounting Hole

N-Channel Enhancement-Mode Silicon Gate

MTW45N10E
Motorola Preferred Device

TMOS POWER FET
45 AMPERES
100 VOLTS
R_{DS(on)} = 0.035 OHM

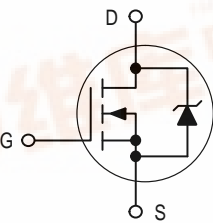
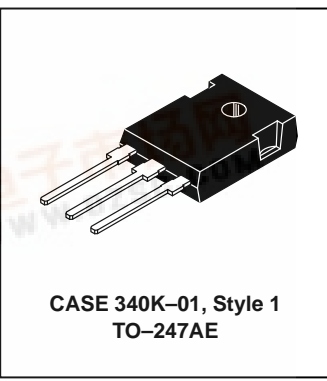

This advanced TMOS E-FET is designed to withstand high energy in the avalanche and commutation modes. The new energy efficient design also offers a drain-to-source diode with a fast recovery time. Designed for low voltage, high speed switching applications in power supplies, converters and PWM motor controls, these devices are particularly well suited for bridge circuits where diode speed and commutating safe operating areas are critical and offer additional safety margin against unexpected voltage transients.

- Avalanche Energy Specified
- Source-to-Drain Diode Recovery Time Comparable to a Discrete Fast Recovery Diode
- Diode is Characterized for Use in Bridge Circuits
- I_{DSS} and V_{DS(on)} Specified at Elevated Temperature
- Isolated Mounting Hole Reduces Mounting Hardware

MAXIMUM RATINGS (T_C = 25°C unless otherwise noted)

| Rating | Symbol | Value | Unit |
|--|-----------------------------------|------------|-------|
| Drain-Source Voltage | V _{DSS} | 100 | Vdc |
| Drain-Gate Voltage (R _{GS} = 1.0 MΩ) | V _{DGR} | 100 | Vdc |
| Gate-Source Voltage — Continuous | V _{GS} | ± 20 | Vdc |
| — Non-Repetitive (t _p ≤ 10 ms) | V _{GSM} | ± 40 | Vpk |
| Drain Current — Continuous | I _D | 45 | Adc |
| — Continuous @ 100°C | I _D | 34.6 | |
| — Single Pulse (t _p ≤ 10 μs) | I _{DM} | 135 | Apk |
| Total Power Dissipation | P _D | 180 | Watts |
| Derate above 25°C | | 1.44 | W/°C |
| Operating and Storage Temperature Range | T _J , T _{stg} | -55 to 150 | °C |
| Single Pulse Drain-to-Source Avalanche Energy — Starting T _J = 25°C (V _{DD} = 25 Vdc, V _{GS} = 10 Vdc, I _L = 45 Apk, L = 0.8 mH, R _G = 25 Ω) | E _{AS} | 810 | mJ |
| Thermal Resistance — Junction to Case | R _{θJC} | 0.70 | °C/W |
| — Junction to Ambient | R _{θJA} | 62.5 | |
| Maximum Lead Temperature for Soldering Purposes, 1/8" from case for 10 seconds | T _L | 260 | °C |

Designer's Data for "Worst Case" Conditions — The Designer's Data Sheet permits the design of most circuits entirely from the information presented. SOA Limit curves — representing boundaries on device characteristics — are given to facilitate "worst case" design.

E-FET and Designer's are trademarks of Motorola, Inc. TMOS is a registered trademark of Motorola, Inc.

Preferred devices are Motorola recommended choices for future use and best overall value.



MTW45N10E

ELECTRICAL CHARACTERISTICS (T_J = 25°C unless otherwise noted)

| Characteristic | Symbol | Min | Typ | Max | Unit |
|----------------|--------|-----|-----|-----|------|
|----------------|--------|-----|-----|-----|------|

OFF CHARACTERISTICS

| | | | | | |
|---|----------------------|----------|----------|-----------|--------------|
| Drain–Source Breakdown Voltage (V _{GS} = 0 Vdc, I _D = 250 μAdc) Temperature Coefficient (Positive) | V _{(BR)DSS} | 100 — | — 116 | — — | Vdc mV/°C |
| Zero Gate Voltage Drain Current (V _{DS} = 100 Vdc, V _{GS} = 0 Vdc) (V _{DS} = 100 Vdc, V _{GS} = 0 Vdc, T _J = 125°C) | I _{DSS} | — — | — — | 10 100 | μAdc |
| Gate–Body Leakage Current (V _{GS} = ± 20 Vdc, V _{DS} = 0) | I _{GSS} | — | — | 100 | nAdc |

ON CHARACTERISTICS (1)

| | | | | | |
|--|---------------------|----------|-----------|--------------|--------------|
| Gate Threshold Voltage (V _{DS} = V _{GS} , I _D = 250 μAdc) Temperature Coefficient (Negative) | V _{GS(th)} | 2.0 — | — 7.0 | 4.0 — | Vdc mV/°C |
| Static Drain–Source On–Resistance (V _{GS} = 10 Vdc, I _D = 22.5 Adc) | R _{DS(on)} | — | 0.027 | 0.035 | Ohm |
| Drain–Source On–Voltage (V _{GS} = 10 Vdc) (I _D = 45 Adc) (I _D = 22.5 Adc, T _J = 125°C) | V _{DS(on)} | — — | 1.13 — | 2.16 1.53 | Vdc |
| Forward Transconductance (V _{DS} = 10 Vdc, I _D = 22.5 Adc) | g _{FS} | 12 | — | — | mhos |

DYNAMIC CHARACTERISTICS

| | | | | | | |
|------------------------------|---|------------------|---|------|------|----|
| Input Capacitance | (V _{DS} = 25 Vdc, V _{GS} = 0 Vdc, f = 1.0 MHz) | C _{iss} | — | 3480 | 5000 | pF |
| Output Capacitance | | C _{oss} | — | 1240 | 2000 | |
| Reverse Transfer Capacitance | | C _{rss} | — | 315 | 650 | |

SWITCHING CHARACTERISTICS (2)

| | | | | | | |
|-------------------------------|---|---------------------|---|-----|-----|----|
| Turn–On Delay Time | (V _{DD} = 50 Vdc, I _D = 45 Adc, V _{GS} = 10 Vdc, R _G = 9.1 Ω) | t _{d(on)} | — | 25 | 50 | ns |
| Rise Time | | t _r | — | 234 | 470 | |
| Turn–Off Delay Time | | t _{d(off)} | — | 83 | 170 | |
| Fall Time | | t _f | — | 116 | 240 | |
| Gate Charge (See Figure 8) | (V _{DS} = 80 Vdc, I _D = 45 Adc, V _{GS} = 10 Vdc) | Q _T | — | 106 | 220 | nC |
| | | Q ₁ | — | 26 | — | |
| | | Q ₂ | — | 54 | — | |
| | | Q ₃ | — | 44 | — | |

SOURCE–DRAIN DIODE CHARACTERISTICS

| | | | | | | |
|--|--|-----------------|--------|--------------|------------|-----|
| Forward On–Voltage (1) | (I _S = 45 Adc, V _{GS} = 0 Vdc) (I _S = 45 Adc, V _{GS} = 0 Vdc, T _J = 125°C) | V _{SD} | — — | 1.09 1.04 | 1.635 — | Vdc |
| Reverse Recovery Time (See Figure 14) | (I _S = 45 Adc, V _{GS} = 0 Vdc, dI _S /dt = 100 A/μs) | t _{rr} | — | 166 | — | ns |
| | | t _a | — | 118 | — | |
| | | t _b | — | 48 | — | |
| Reverse Recovery Stored Charge | | Q _R | — | 1.1 | — | μC |

INTERNAL PACKAGE INDUCTANCE

| | | | | | |
|---|----------------|---|-----|---|----|
| Internal Drain Inductance (Measured from the drain lead 0.25" from package to center of die) | L _D | — | 4.5 | — | nH |
| Internal Source Inductance (Measured from the source lead 0.25" from package to source bond pad) | L _S | — | 7.5 | — | nH |

(1) Pulse Test: Pulse Width ≤ 300 μs, Duty Cycle ≤ 2%.

(2) Switching characteristics are independent of operating junction temperature.

TYPICAL ELECTRICAL CHARACTERISTICS

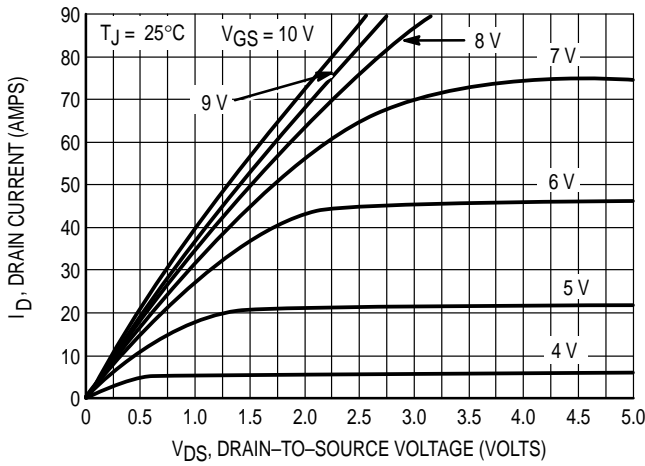

Figure 1. On-Region Characteristics

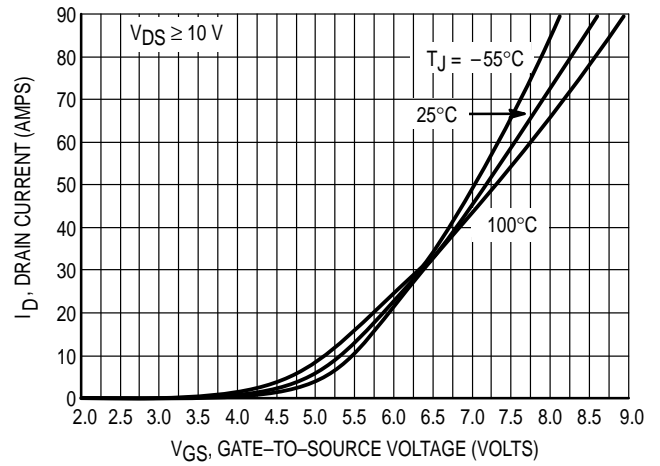

Figure 2. Transfer Characteristics

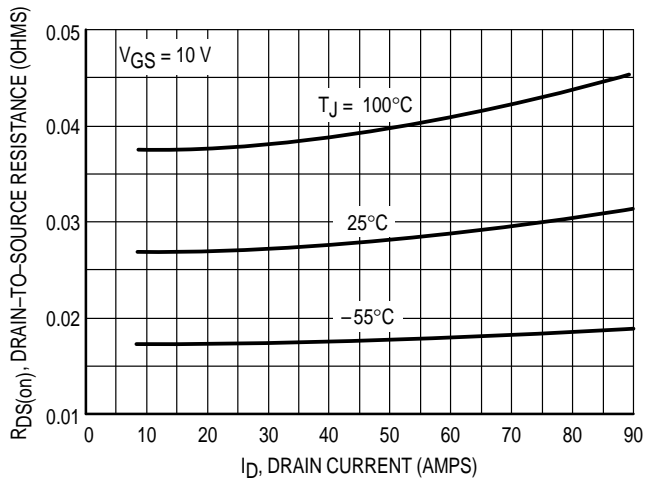

Figure 3. On-Resistance versus Drain Current and Temperature

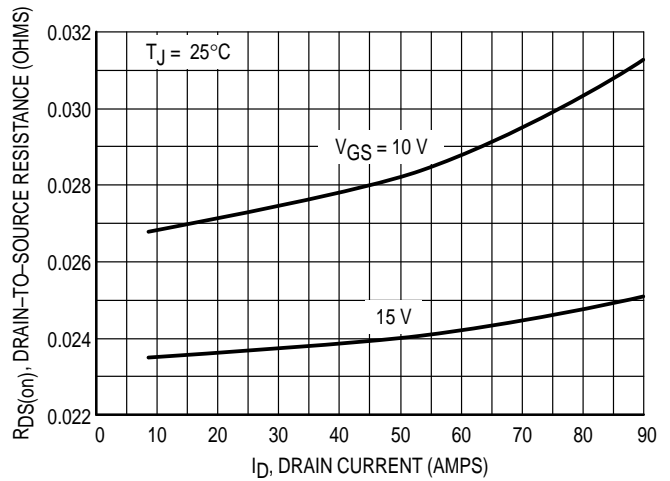

Figure 4. On-Resistance versus Drain Current and Gate Voltage

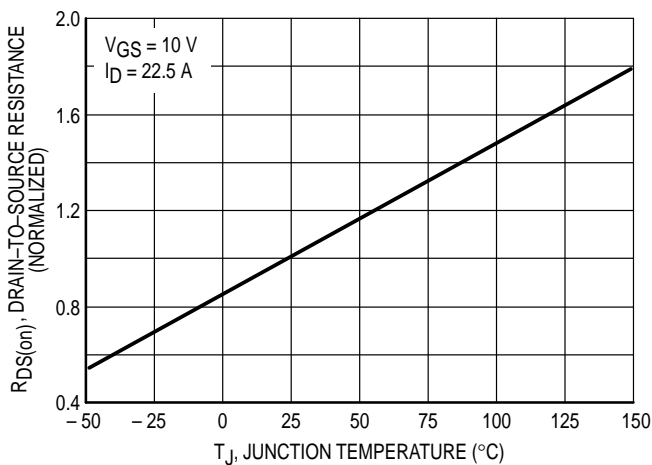

Figure 5. On-Resistance Variation with Temperature

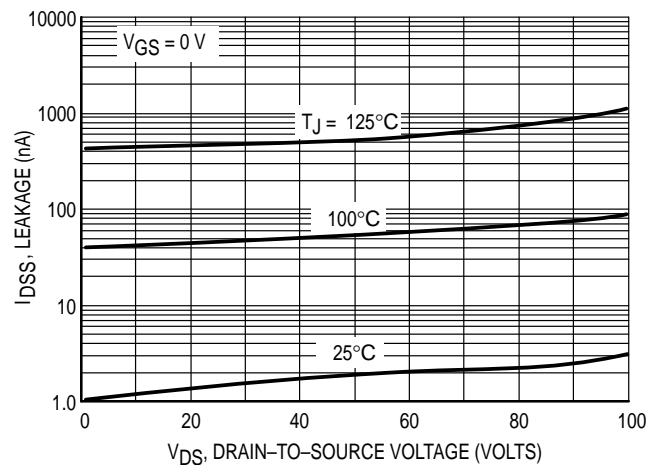

Figure 6. Drain-To-Source Leakage Current versus Voltage

POWER MOSFET SWITCHING

Switching behavior is most easily modeled and predicted by recognizing that the power MOSFET is charge controlled. The lengths of various switching intervals (Δt) are determined by how fast the FET input capacitance can be charged by current from the generator.

The published capacitance data is difficult to use for calculating rise and fall because drain–gate capacitance varies greatly with applied voltage. Accordingly, gate charge data is used. In most cases, a satisfactory estimate of average input current ($I_{G(AV)}$) can be made from a rudimentary analysis of the drive circuit so that

$$t = Q/I_{G(AV)}$$

During the rise and fall time interval when switching a resistive load, V_{GS} remains virtually constant at a level known as the plateau voltage, V_{GSP} . Therefore, rise and fall times may be approximated by the following:

$$t_r = Q_2 \times R_G / (V_{GG} - V_{GSP})$$

$$t_f = Q_2 \times R_G / V_{GSP}$$

where

V_{GG} = the gate drive voltage, which varies from zero to V_{GG}

R_G = the gate drive resistance

and Q_2 and V_{GSP} are read from the gate charge curve.

During the turn–on and turn–off delay times, gate current is not constant. The simplest calculation uses appropriate values from the capacitance curves in a standard equation for voltage change in an RC network. The equations are:

$$t_{d(on)} = R_G C_{iss} \ln [V_{GG} / (V_{GG} - V_{GSP})]$$

$$t_{d(off)} = R_G C_{iss} \ln (V_{GG} / V_{GSP})$$

The capacitance (C_{iss}) is read from the capacitance curve at a voltage corresponding to the off–state condition when calculating $t_{d(on)}$ and is read at a voltage corresponding to the on–state when calculating $t_{d(off)}$.

At high switching speeds, parasitic circuit elements complicate the analysis. The inductance of the MOSFET source lead, inside the package and in the circuit wiring which is common to both the drain and gate current paths, produces a voltage at the source which reduces the gate drive current. The voltage is determined by $L di/dt$, but since di/dt is a function of drain current, the mathematical solution is complex. The MOSFET output capacitance also complicates the mathematics. And finally, MOSFETs have finite internal gate resistance which effectively adds to the resistance of the driving source, but the internal resistance is difficult to measure and, consequently, is not specified.

The resistive switching time variation versus gate resistance (Figure 9) shows how typical switching performance is affected by the parasitic circuit elements. If the parasitics were not present, the slope of the curves would maintain a value of unity regardless of the switching speed. The circuit used to obtain the data is constructed to minimize common inductance in the drain and gate circuit loops and is believed readily achievable with board mounted components. Most power electronic loads are inductive; the data in the figure is taken with a resistive load, which approximates an optimally snubbed inductive load. Power MOSFETs may be safely operated into an inductive load; however, snubbing reduces switching losses.

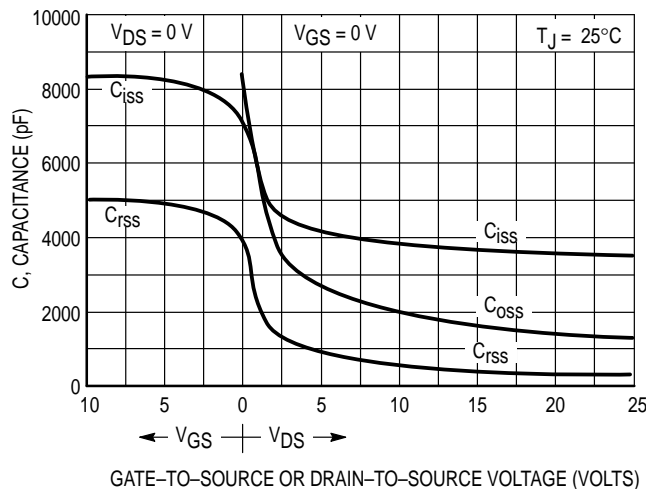

Figure 7. Capacitance Variation

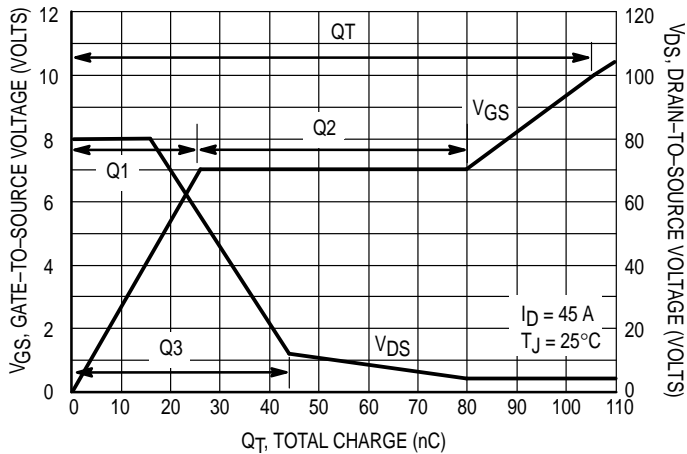

Figure 8. Gate-To-Source and Drain-To-Source Voltage versus Total Charge

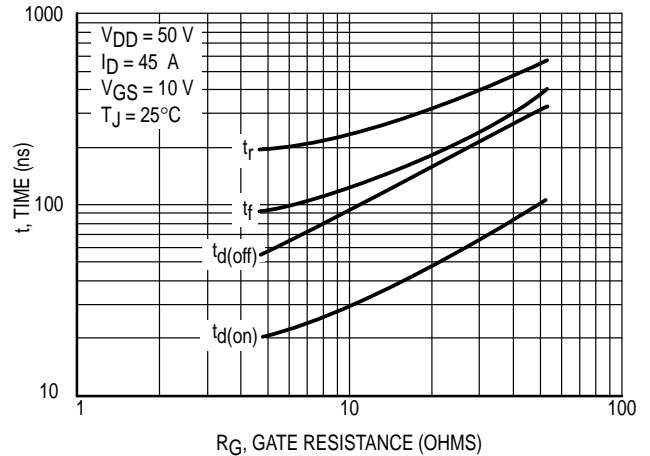

Figure 9. Resistive Switching Time Variation versus Gate Resistance

DRAIN-TO-SOURCE DIODE CHARACTERISTICS

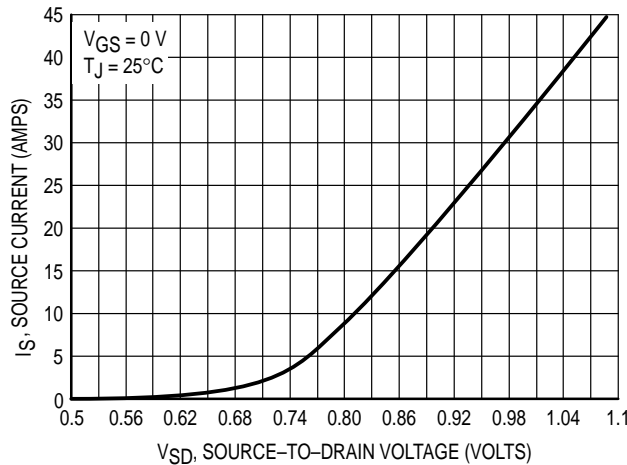

Figure 10. Diode Forward Voltage versus Current

SAFE OPERATING AREA

The Forward Biased Safe Operating Area curves define the maximum simultaneous drain-to-source voltage and drain current that a transistor can handle safely when it is forward biased. Curves are based upon maximum peak junction temperature and a case temperature (T_C) of 25°C. Peak repetitive pulsed power limits are determined by using the thermal response data in conjunction with the procedures discussed in AN569, "Transient Thermal Resistance—General Data and Its Use."

Switching between the off-state and the on-state may traverse any load line provided neither rated peak current (I_{DM}) nor rated voltage (V_{DSS}) is exceeded and the transition time (t_r, t_f) do not exceed 10 μs . In addition the total power averaged over a complete switching cycle must not exceed $(T_J(MAX) - T_C)/(R_{\theta JC})$.

A Power MOSFET designated E-FET can be safely used in switching circuits with unclamped inductive loads. For reli-

able operation, the stored energy from circuit inductance dissipated in the transistor while in avalanche must be less than the rated limit and adjusted for operating conditions differing from those specified. Although industry practice is to rate in terms of energy, avalanche energy capability is not a constant. The energy rating decreases non-linearly with an increase of peak current in avalanche and peak junction temperature.

Although many E-FETs can withstand the stress of drain-to-source avalanche at currents up to rated pulsed current (I_{DM}), the energy rating is specified at rated continuous current (I_D), in accordance with industry custom. The energy rating must be derated for temperature as shown in the accompanying graph (Figure 12). Maximum energy at currents below rated continuous I_D can safely be assumed to equal the values indicated.

MTW45N10E

SAFE OPERATING AREA

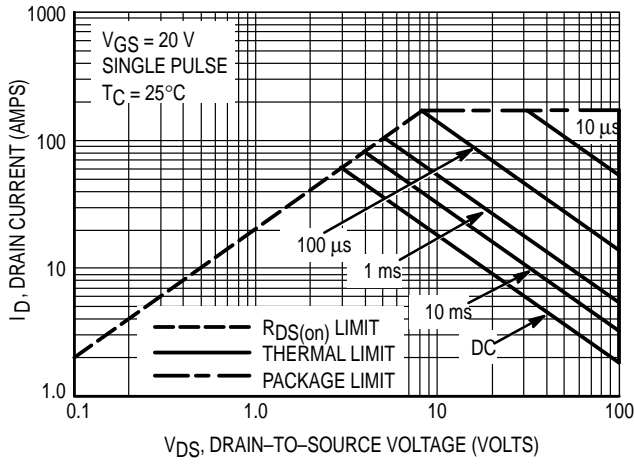

Figure 11. Maximum Rated Forward Biased Safe Operating Area

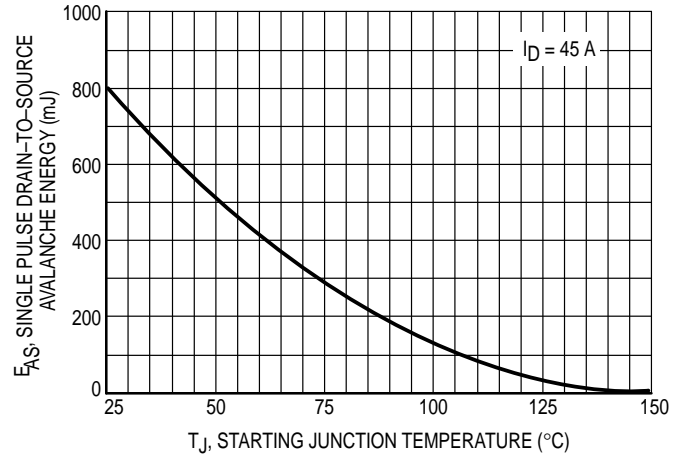

Figure 12. Maximum Avalanche Energy versus Starting Junction Temperature

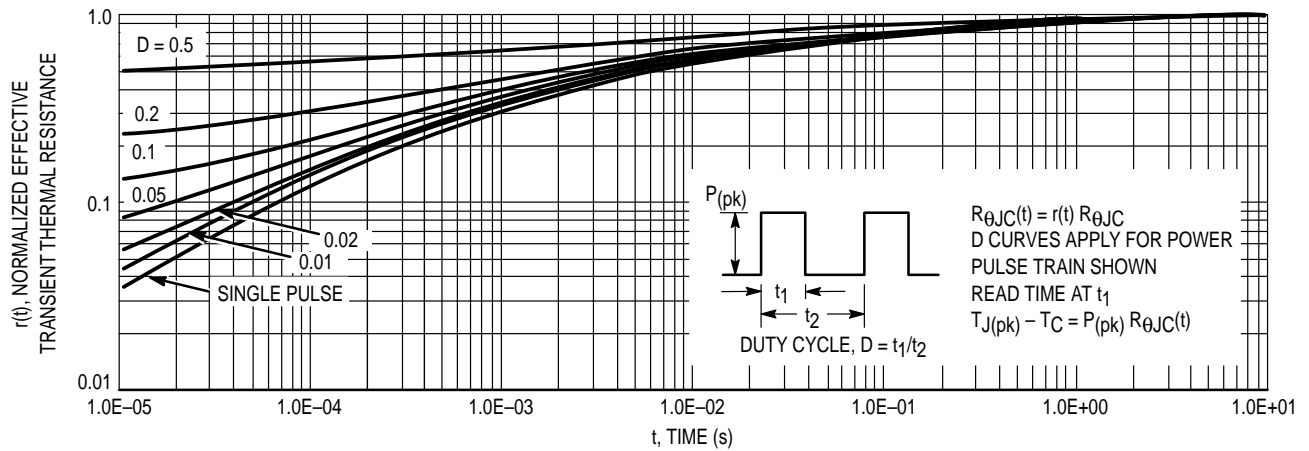

Figure 13. Thermal Response

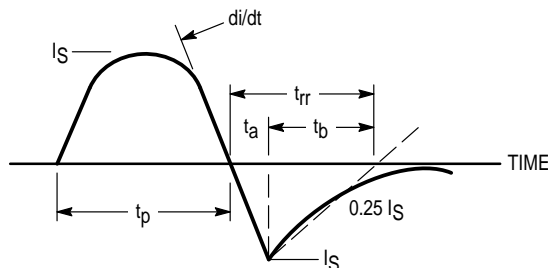
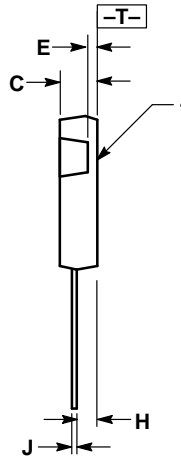
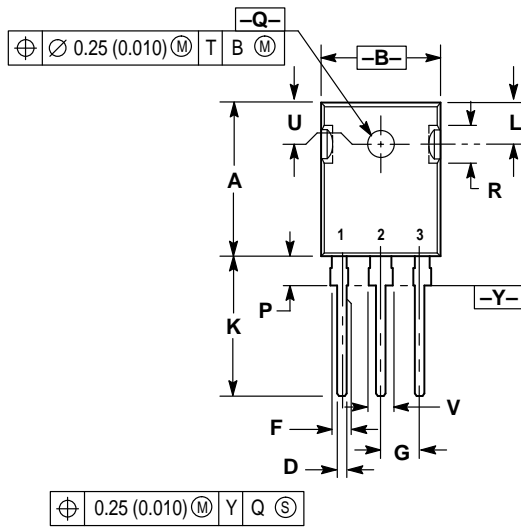

Figure 14. Diode Reverse Recovery Waveform

PACKAGE DIMENSIONS



- NOTES:
1. DIMENSIONING AND TOLERANCING PER ANSI Y14.5M, 1982.
 2. CONTROLLING DIMENSION: MILLIMETER.

| DIM | MILLIMETERS | | INCHES | |
|-----|-------------|------|-----------|-------|
| | MIN | MAX | MIN | MAX |
| A | 19.7 | 20.3 | 0.776 | 0.799 |
| B | 15.3 | 15.9 | 0.602 | 0.626 |
| C | 4.7 | 5.3 | 0.185 | 0.209 |
| D | 1.0 | 1.4 | 0.039 | 0.055 |
| E | 1.27 REF | | 0.050 REF | |
| F | 2.0 | 2.4 | 0.079 | 0.094 |
| G | 5.5 BSC | | 0.216 BSC | |
| H | 2.2 | 2.6 | 0.087 | 0.102 |
| J | 0.4 | 0.8 | 0.016 | 0.031 |
| K | 14.2 | 14.8 | 0.559 | 0.583 |
| L | 5.5 NOM | | 0.217 NOM | |
| P | 3.7 | 4.3 | 0.146 | 0.169 |
| Q | 3.55 | 3.65 | 0.140 | 0.144 |
| R | 5.0 NOM | | 0.197 NOM | |
| U | 5.5 BSC | | 0.217 BSC | |
| V | 3.0 | 3.4 | 0.118 | 0.134 |

- STYLE 1:
 PIN 1. GATE
 2. DRAIN
 3. SOURCE
 4. DRAIN

CASE 340K-01
 ISSUE O

MTW45N10E

Motorola reserves the right to make changes without further notice to any products herein. Motorola makes no warranty, representation or guarantee regarding the suitability of its products for any particular purpose, nor does Motorola assume any liability arising out of the application or use of any product or circuit, and specifically disclaims any and all liability, including without limitation consequential or incidental damages. "Typical" parameters which may be provided in Motorola data sheets and/or specifications can and do vary in different applications and actual performance may vary over time. All operating parameters, including "Typicals" must be validated for each customer application by customer's technical experts. Motorola does not convey any license under its patent rights nor the rights of others. Motorola products are not designed, intended, or authorized for use as components in systems intended for surgical implant into the body, or other applications intended to support or sustain life, or for any other application in which the failure of the Motorola product could create a situation where personal injury or death may occur. Should Buyer purchase or use Motorola products for any such unintended or unauthorized application, Buyer shall indemnify and hold Motorola and its officers, employees, subsidiaries, affiliates, and distributors harmless against all claims, costs, damages, and expenses, and reasonable attorney fees arising out of, directly or indirectly, any claim of personal injury or death associated with such unintended or unauthorized use, even if such claim alleges that Motorola was negligent regarding the design or manufacture of the part. Motorola and  are registered trademarks of Motorola, Inc. Motorola, Inc. is an Equal Opportunity/Affirmative Action Employer.

How to reach us:

USA/EUROPE/Locations Not Listed: Motorola Literature Distribution;
P.O. Box 20912; Phoenix, Arizona 85036. 1-800-441-2447 or 602-303-5454

MFAX: RMFAX0@email.sps.mot.com – TOUCHTONE 602-244-6609
INTERNET: <http://Design-NET.com>

JAPAN: Nippon Motorola Ltd.; Tatsumi-SPD-JLDC, 6F Seibu-Butsuryu-Center,
3-14-2 Tatsumi Koto-Ku, Tokyo 135, Japan. 03-81-3521-8315

ASIA/PACIFIC: Motorola Semiconductors H.K. Ltd.; 8B Tai Ping Industrial Park,
51 Ting Kok Road, Tai Po, N.T., Hong Kong. 852-26629298



MOTOROLA