

MUN5111T1 Series

Preferred Devices

Bias Resistor Transistor

PNP Silicon Surface Mount Transistor with Monolithic Bias Resistor Network

This new series of digital transistors is designed to replace a single device and its external resistor bias network. The Bias Resistor Transistor (BRT) contains a single transistor with a monolithic bias network consisting of two resistors; a series base resistor and a base-emitter resistor. The BRT eliminates these individual components by integrating them into a single device. The use of a BRT can reduce both system cost and board space. The device is housed in the SC-70/SOT-323 package which is designed for low power surface mount applications.

Features

- Pb-Free Packages are Available
- Simplifies Circuit Design
- Reduces Board Space
- Reduces Component Count
- The SC-70/SOT-323 package can be soldered using wave or reflow. The modified gull-winged leads absorb thermal stress during soldering eliminating the possibility of damage to the die.
- Available in 8 mm embossed tape and reel – Use the Device Number to order the 7 inch/3000 unit reel. Replace “T1” with “T3” in the Device Number to order the 13 inch/10,000 unit reel.

MAXIMUM RATINGS ($T_A = 25^\circ\text{C}$ unless otherwise noted)

| Rating | Symbol | Value | Unit |
|---------------------------|-----------|-------|------|
| Collector-Base Voltage | V_{CBO} | 50 | Vdc |
| Collector-Emitter Voltage | V_{CEO} | 50 | Vdc |
| Collector Current | I_C | 100 | mAdc |

Maximum ratings are those values beyond which device damage can occur. Maximum ratings applied to the device are individual stress limit values (not normal operating conditions) and are not valid simultaneously. If these limits are exceeded, device functional operation is not implied, damage may occur and reliability may be affected.

THERMAL CHARACTERISTICS

| Characteristic | Symbol | Max | Unit |
|---|-----------------|--|--------------------------|
| Total Device Dissipation $T_A = 25^\circ\text{C}$ Derate above 25°C | P_D | 202 (Note 1) 310 (Note 2) 1.6 (Note 1) 2.5 (Note 2) | mW $^\circ\text{C/W}$ |
| Thermal Resistance, Junction-to-Ambient | $R_{\theta JA}$ | 618 (Note 1) 403 (Note 2) | $^\circ\text{C/W}$ |
| Thermal Resistance, Junction-to-Lead | $R_{\theta JL}$ | 280 (Note 1) 332 (Note 2) | $^\circ\text{C/W}$ |
| Junction and Storage Temperature Range | T_J, T_{stg} | -55 to +150 | $^\circ\text{C}$ |

1. FR-4 @ Minimum Pad
2. FR-4 @ 1.0 x 1.0 inch Pad



ON Semiconductor®

<http://onsemi.com>

PNP SILICON BIAS RESISTOR TRANSISTORS

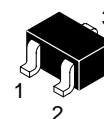
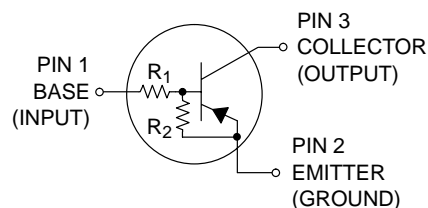

SC-70/SOT-323
CASE 419
STYLE 3

MARKING DIAGRAM

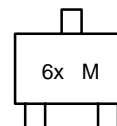

6x = Specific Device Code
(See Order Info Table)
M = Date Code

ORDERING INFORMATION

See specific ordering and shipping information in the package dimensions section on page 2 of this data sheet.

Preferred devices are recommended choices for future use and best overall value.

MUN511T1 Series

ORDERING INFORMATION AND RESISTOR VALUES

| Device | Package | Marking | R1 (K) | R2 (K) | Shipping† |
|------------------------|----------------------------|---------|--------|--------|--|
| MUN511T1 | SC-70/SOT-323 | 6A | 10 | 10 | 3000/Tape & Reel |
| MUN511T1G | SC-70/SOT-323 (Pb-Free) | 6A | 10 | 10 | 3000/Tape & Reel |
| MUN5112T1 | SC-70/SOT-323 | 6B | 22 | 22 | 3000/Tape & Reel |
| MUN5112T1G | SC-70/SOT-323 (Pb-Free) | 6B | 22 | 22 | 3000/Tape & Reel |
| MUN5113T1 MUN5113T3 | SC-70/SOT-323 | 6C | 47 | 47 | 3000/Tape & Reel 10,000/Tape & Reel |
| MUN5113T1G | SC-70/SOT-323 (Pb-Free) | 6C | 47 | 47 | 3000/Tape & Reel |
| MUN5114T1 | SC-70/SOT-323 | 6D | 10 | 47 | 3000/Tape & Reel |
| MUN5114T1G | SC-70/SOT-323 (Pb-Free) | 6D | 10 | 47 | 3000/Tape & Reel |
| MUN5115T1 (Note 3) | SC-70/SOT-323 | 6E | 10 | ∞ | 3000/Tape & Reel |
| MUN5115T1G (Note 3) | SC-70/SOT-323 (Pb-Free) | 6E | 10 | ∞ | 3000/Tape & Reel |
| MUN5116T1 (Note 3) | SC-70/SOT-323 | 6F | 4.7 | ∞ | 3000/Tape & Reel |
| MUN5130T1 (Note 3) | SC-70/SOT-323 | 6G | 1.0 | 1.0 | 3000/Tape & Reel |
| MUN5130T1G (Note 3) | SC-70/SOT-323 (Pb-Free) | 6G | 1.0 | 1.0 | 3000/Tape & Reel |
| MUN5131T1 (Note 3) | SC-70/SOT-323 | 6H | 2.2 | 2.2 | 3000/Tape & Reel |
| MUN5131T1G (Note 3) | SC-70/SOT-323 (Pb-Free) | 6H | 2.2 | 2.2 | 3000/Tape & Reel |
| MUN5132T1 (Note 3) | SC-70/SOT-323 | 6J | 4.7 | 4.7 | 3000/Tape & Reel |
| MUN5132T1G (Note 3) | SC-70/SOT-323 (Pb-Free) | 6J | 4.7 | 4.7 | 3000/Tape & Reel |
| MUN5133T1 (Note 3) | SC-70/SOT-323 | 6K | 4.7 | 47 | 3000/Tape & Reel |
| MUN5133T1G (Note 3) | SC-70/SOT-323 (Pb-Free) | 6K | 4.7 | 47 | 3000/Tape & Reel |
| MUN5134T1 (Note 3) | SC-70/SOT-323 | 6L | 22 | 47 | 3000/Tape & Reel |
| MUN5135T1 (Note 3) | SC-70/SOT-323 | 6M | 2.2 | 47 | 3000/Tape & Reel |
| MUN5136T1 | SC-70/SOT-323 | 6N | 100 | 100 | 3000/Tape & Reel |
| MUN5137T1 | SC-70/SOT-323 | 6P | 47 | 22 | 3000/Tape & Reel |

†For information on tape and reel specifications, including part orientation and tape sizes, please refer to our Tape and Reel Packaging Specifications Brochure, BRD8011/D.

3. New devices. Updated curves to follow in subsequent data sheets.

MUN511T1 Series

ELECTRICAL CHARACTERISTICS (T_A = 25°C unless otherwise noted)

| Characteristic | Symbol | Min | Typ | Max | Unit |
|---|----------------------|-----|-----|------|------|
| OFF CHARACTERISTICS | | | | | |
| Collector–Base Cutoff Current (V _{CB} = 50 V, I _E = 0) | I _{CBO} | – | – | 100 | nAdc |
| Collector–Emitter Cutoff Current (V _{CE} = 50 V, I _B = 0) | I _{CEO} | – | – | 500 | nAdc |
| Emitter–Base Cutoff Current (V _{EB} = 6.0 V, I _C = 0) | I _{EBO} | – | – | 0.5 | mAdc |
| | MUN5111T1 | – | – | 0.2 | |
| | MUN5112T1 | – | – | 0.1 | |
| | MUN5113T1 | – | – | 0.2 | |
| | MUN5114T1 | – | – | 0.9 | |
| | MUN5115T1 | – | – | 1.9 | |
| | MUN5116T1 | – | – | 4.3 | |
| | MUN5130T1 | – | – | 2.3 | |
| | MUN5131T1 | – | – | 1.5 | |
| | MUN5132T1 | – | – | 0.18 | |
| | MUN5133T1 | – | – | 0.13 | |
| | MUN5134T1 | – | – | 0.2 | |
| | MUN5135T1 | – | – | 0.05 | |
| | MUN5136T1 | – | – | 0.13 | |
| | MUN5137T1 | – | – | | |
| Collector–Base Breakdown Voltage (I _C = 10 μA, I _E = 0) | V _{(BR)CBO} | 50 | – | – | Vdc |
| Collector–Emitter Breakdown Voltage (Note 4) (I _C = 2.0 mA, I _B = 0) | V _{(BR)CEO} | 50 | – | – | Vdc |

ON CHARACTERISTICS (Note 4)

| | | | | | |
|--|----------------------|-----|-----|------|-----|
| DC Current Gain (V _{CE} = 10 V, I _C = 5.0 mA) | h _{FE} | 35 | 60 | – | |
| | MUN5111T1 | 60 | 100 | – | |
| | MUN5112T1 | 80 | 140 | – | |
| | MUN5113T1 | 80 | 140 | – | |
| | MUN5114T1 | 160 | 250 | – | |
| | MUN5115T1 | 160 | 250 | – | |
| | MUN5116T1 | 3.0 | 5.0 | – | |
| | MUN5130T1 | 8.0 | 15 | – | |
| | MUN5131T1 | 15 | 27 | – | |
| | MUN5132T1 | 80 | 140 | – | |
| | MUN5133T1 | 80 | 130 | – | |
| | MUN5134T1 | 80 | 140 | – | |
| | MUN5135T1 | 80 | 150 | – | |
| | MUN5136T1 | 80 | 140 | – | |
| | MUN5137T1 | | | | |
| Collector–Emitter Saturation Voltage (I _C = 10 mA, I _E = 0.3 mA) (I _C = 10 mA, I _B = 5 mA) MUN5130T1/MUN5131T1 (I _C = 10 mA, I _B = 1 mA) MUN5115T1/MUN5116T1/ MUN5132T1/MUN5133T1/MUN5134T1 | V _{CE(sat)} | – | – | 0.25 | Vdc |
| Output Voltage (on) (V _{CC} = 5.0 V, V _B = 2.5 V, R _L = 1.0 kΩ) | V _{OL} | – | – | 0.2 | Vdc |
| | MUN5111T1 | – | – | 0.2 | |
| | MUN5112T1 | – | – | 0.2 | |
| | MUN5114T1 | – | – | 0.2 | |
| | MUN5115T1 | – | – | 0.2 | |
| | MUN5116T1 | – | – | 0.2 | |
| | MUN5130T1 | – | – | 0.2 | |
| | MUN5131T1 | – | – | 0.2 | |
| | MUN5132T1 | – | – | 0.2 | |
| | MUN5133T1 | – | – | 0.2 | |
| | MUN5134T1 | – | – | 0.2 | |
| | MUN5135T1 | – | – | 0.2 | |
| (V _{CC} = 5.0 V, V _B = 3.5 V, R _L = 1.0 kΩ) | MUN5113T1 | – | – | 0.2 | |
| (V _{CC} = 5.0 V, V _B = 5.5 V, R _L = 1.0 kΩ) | MUN5136T1 | – | – | 0.2 | |
| (V _{CC} = 5.0 V, V _B = 4.0 V, R _L = 1.0 kΩ) | MUN5137T1 | – | – | 0.2 | |

4. Pulse Test: Pulse Width < 300 μs, Duty Cycle < 2.0%

MUN511T1 Series

ELECTRICAL CHARACTERISTICS ($T_A = 25^\circ\text{C}$ unless otherwise noted) (Continued)

| Characteristic | Symbol | Min | Typ | Max | Unit |
|---|-----------|-------|-------|-------|------------|
| Output Voltage (off) ($V_{CC} = 5.0\text{ V}$, $V_B = 0.5\text{ V}$, $R_L = 1.0\text{ k}\Omega$) ($V_{CC} = 5.0\text{ V}$, $V_B = 0.050\text{ V}$, $R_L = 1.0\text{ k}\Omega$) ($V_{CC} = 5.0\text{ V}$, $V_B = 0.25\text{ V}$, $R_L = 1.0\text{ k}\Omega$) | V_{OH} | 4.9 | – | – | Vdc |
| Input Resistor | | | | | |
| MUN5111T1 | R1 | 7.0 | 10 | 13 | k Ω |
| MUN5112T1 | | 15.4 | 22 | 28.6 | |
| MUN5113T1 | | 32.9 | 47 | 61.1 | |
| MUN5114T1 | | 7.0 | 10 | 13 | |
| MUN5115T1 | | 7.0 | 10 | 13 | |
| MUN5116T1 | | 3.3 | 4.7 | 6.1 | |
| MUN5130T1 | | 0.7 | 1.0 | 1.3 | |
| MUN5131T1 | | 1.5 | 2.2 | 2.9 | |
| MUN5132T1 | | 3.3 | 4.7 | 6.1 | |
| MUN5133T1 | | 3.3 | 4.7 | 6.1 | |
| MUN5134T1 | | 15.4 | 22 | 28.6 | |
| MUN5135T1 | | 1.54 | 2.2 | 2.86 | |
| MUN5136T1 | | 70 | 100 | 130 | |
| MUN5137T1 | | 32.9 | 47 | 61.1 | |
| Resistor Ratio | | | | | |
| MUN5111T1/MUN5112T1/MUN5113T1/ MUN5136T1 | R_1/R_2 | 0.8 | 1.0 | 1.2 | |
| MUN5114T1 | | 0.17 | 0.21 | 0.25 | |
| MUN5115T1/MUN5116T1 | | – | – | – | |
| MUN5130T1/MUN5131T1/MUN5132T1 | | 0.8 | 1.0 | 1.2 | |
| MUN5133T1 | | 0.055 | 0.1 | 0.185 | |
| MUN5134T1 | | 0.38 | 0.47 | 0.56 | |
| MUN5135T1 | | 0.038 | 0.047 | 0.056 | |
| MUN5137T1 | | 1.7 | 2.1 | 2.6 | |

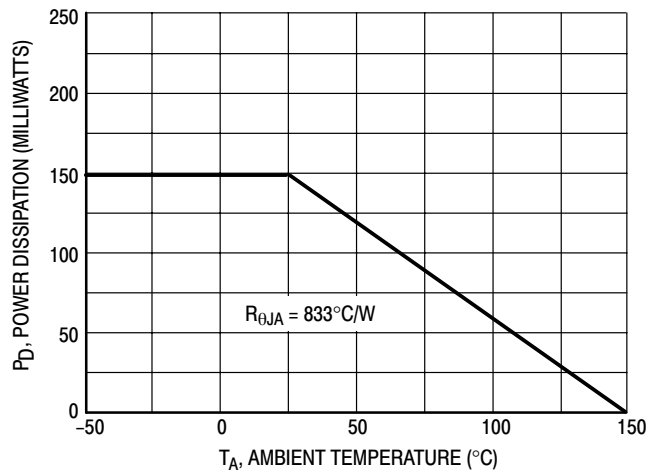

Figure 1. Derating Curve

MUN511T1 Series

TYPICAL ELECTRICAL CHARACTERISTICS – MUN511T1

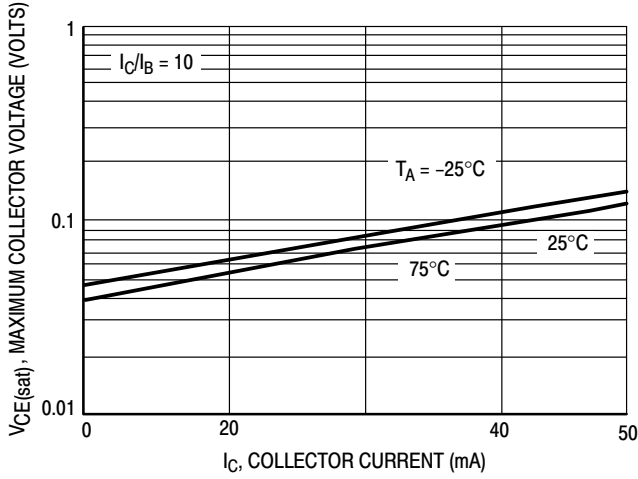

Figure 2. $V_{CE(sat)}$ versus I_C

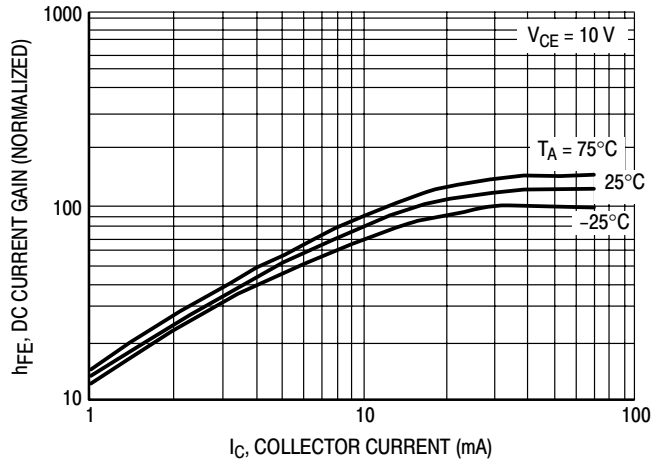

Figure 3. DC Current Gain

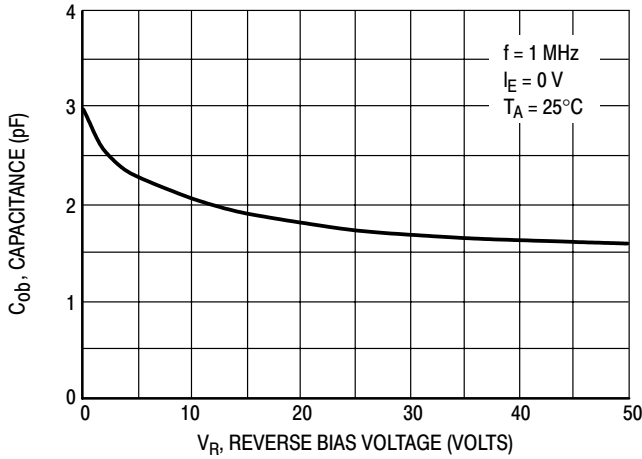

Figure 4. Output Capacitance

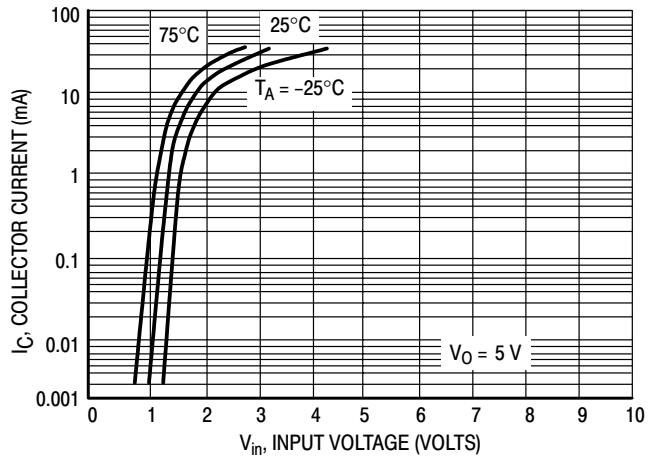

Figure 5. Output Current versus Input Voltage

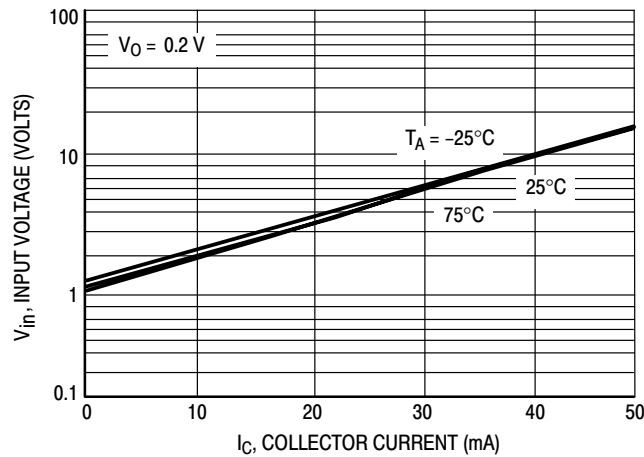

Figure 6. Input Voltage versus Output Current

MUN511T1 Series

TYPICAL ELECTRICAL CHARACTERISTICS – MUN511T1

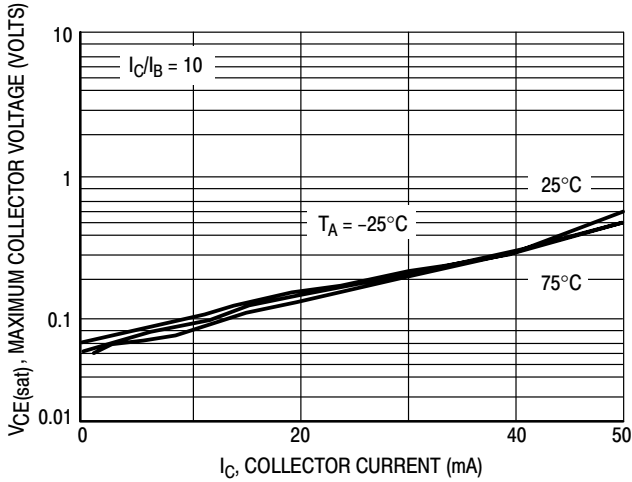

Figure 7. $V_{CE(sat)}$ versus I_C

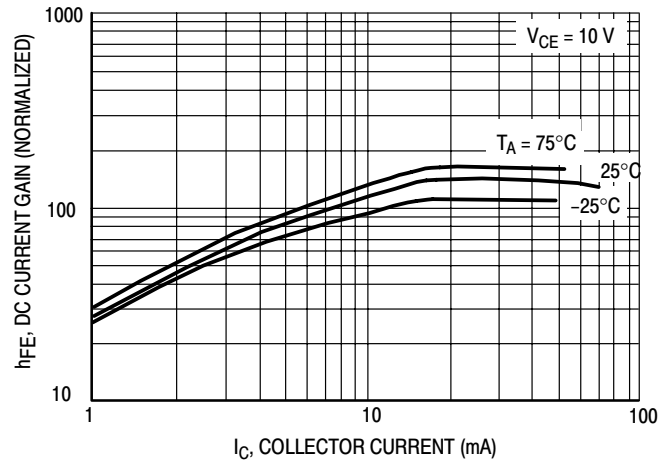

Figure 8. DC Current Gain

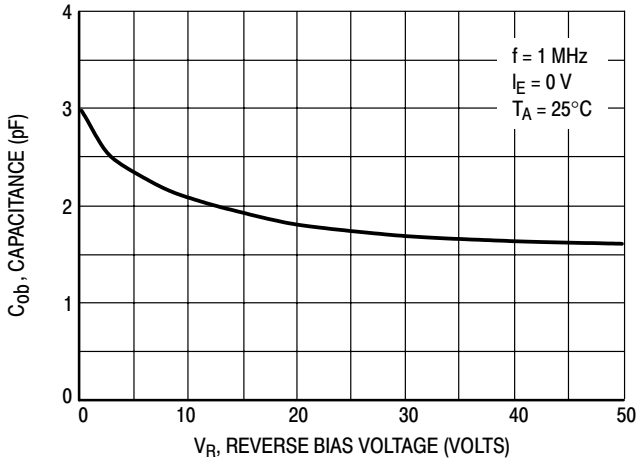

Figure 9. Output Capacitance

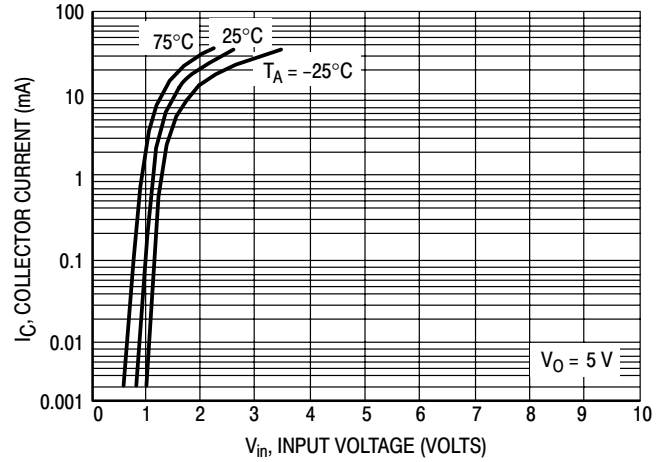

Figure 10. Output Current versus Input Voltage

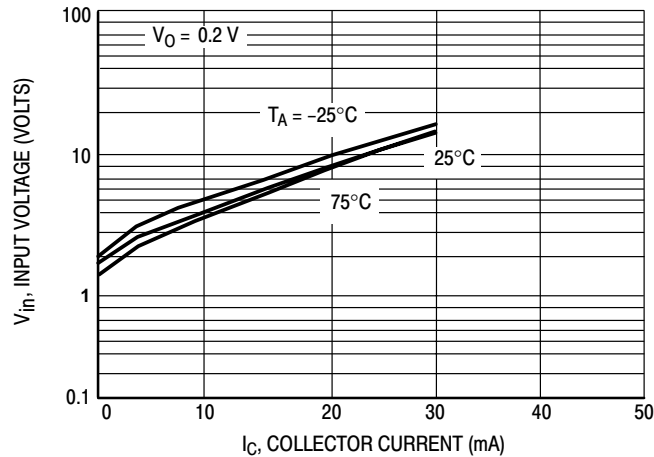

Figure 11. Input Voltage versus Output Current

MUN511T1 Series

TYPICAL ELECTRICAL CHARACTERISTICS – MUN5113T1

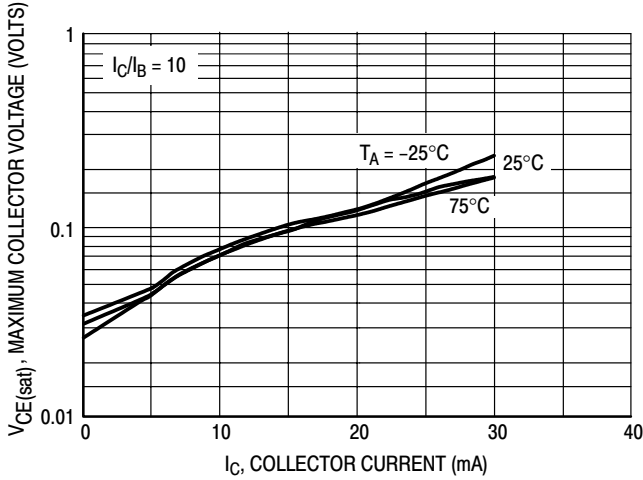

Figure 12. $V_{CE(sat)}$ versus I_C

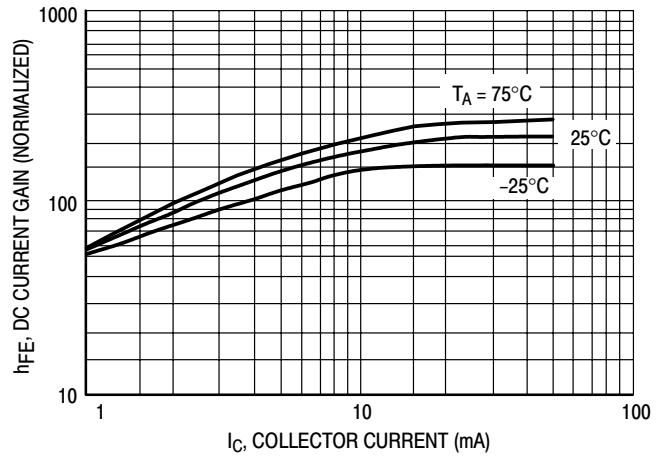

Figure 13. DC Current Gain

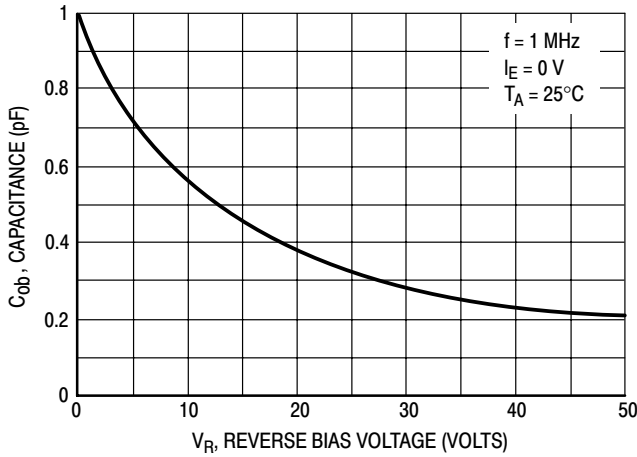

Figure 14. Output Capacitance

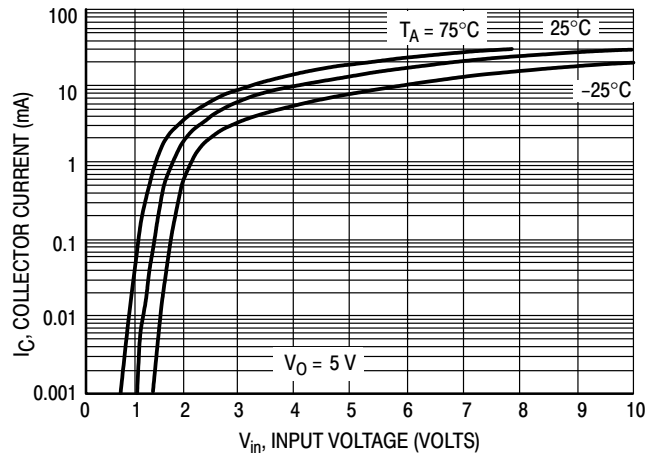

Figure 15. Output Current versus Input Voltage

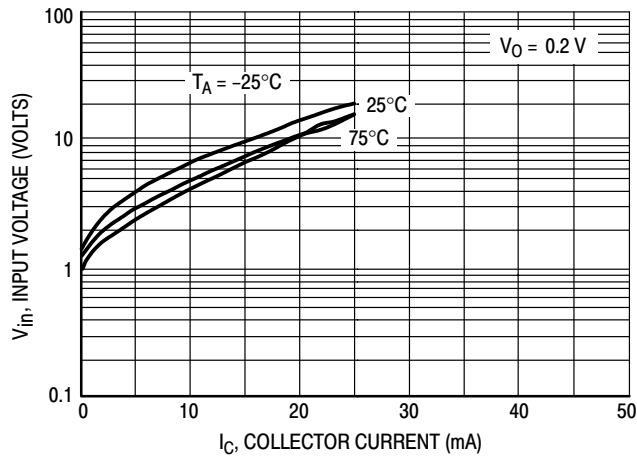

Figure 16. Input Voltage versus Output Current

MUN5111T1 Series

TYPICAL ELECTRICAL CHARACTERISTICS – MUN5114T1

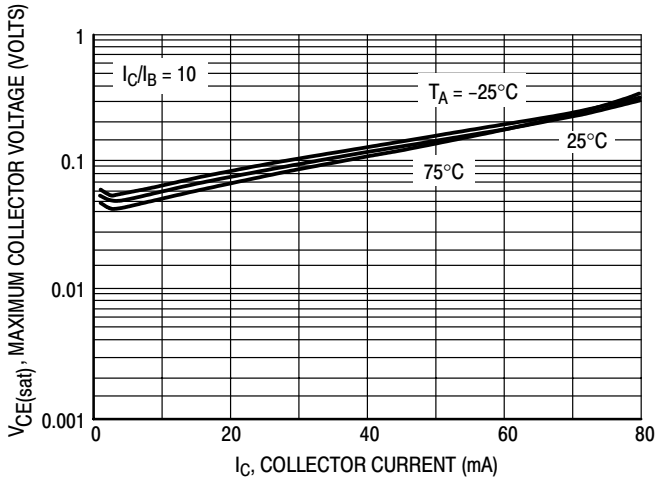

Figure 17. $V_{CE(sat)}$ versus I_C

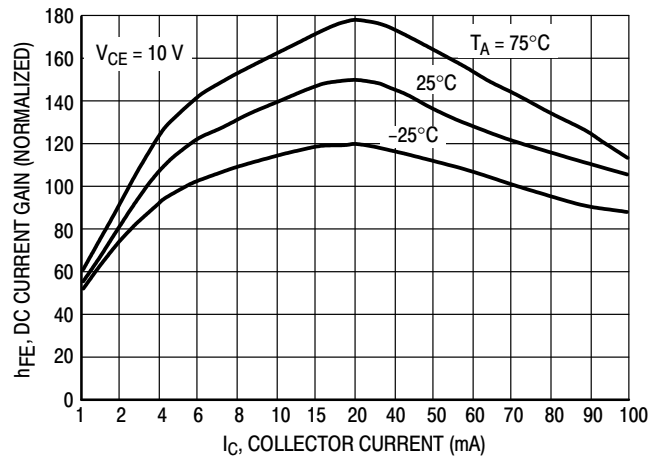

Figure 18. DC Current Gain

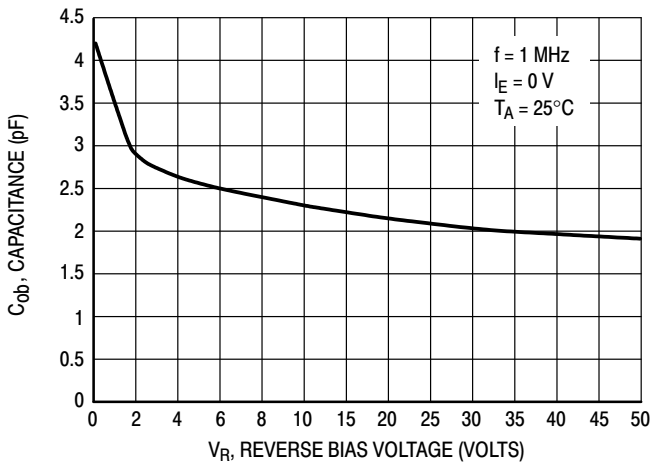

Figure 19. Output Capacitance

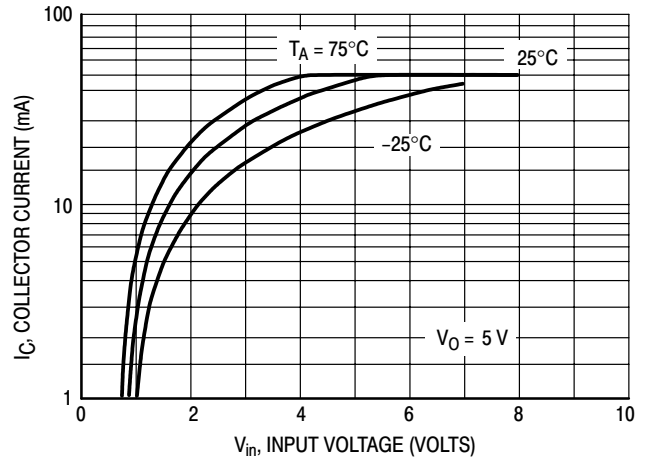

Figure 20. Output Current versus Input Voltage

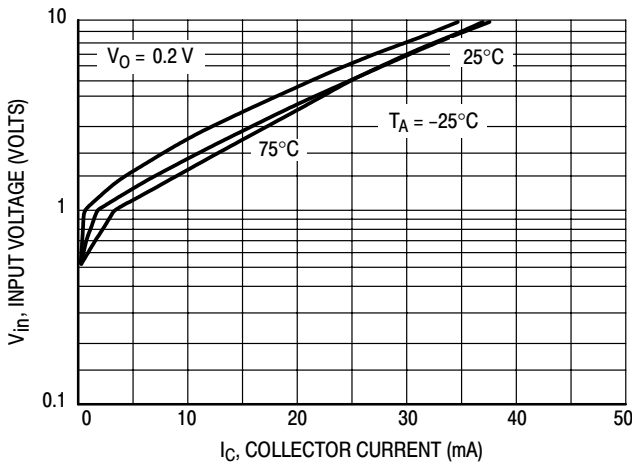

Figure 21. Input Voltage versus Output Current

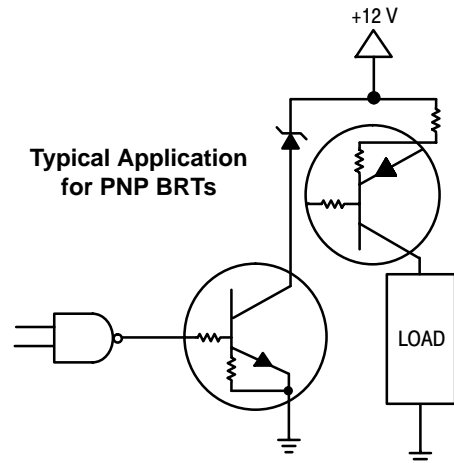

Figure 22. Inexpensive, Unregulated Current Source

MUN5111T1 Series

TYPICAL ELECTRICAL CHARACTERISTICS — MUN5132T1

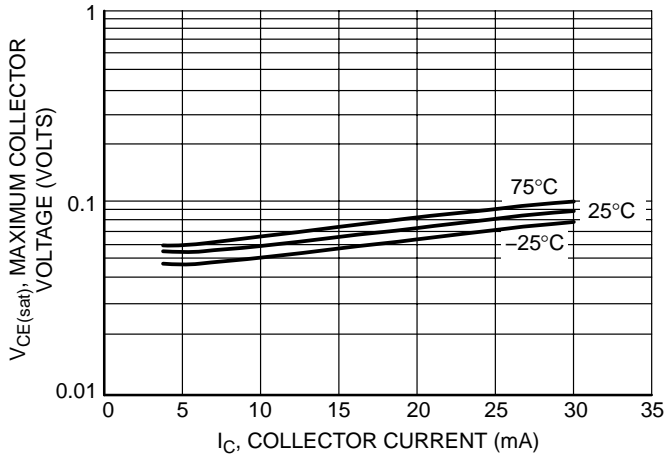

Figure 23. Maximum Collector Voltage versus Collector Current

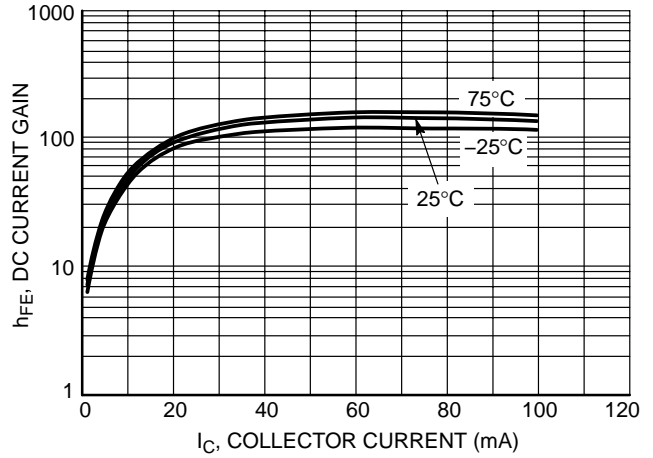

Figure 24. DC Current Gain

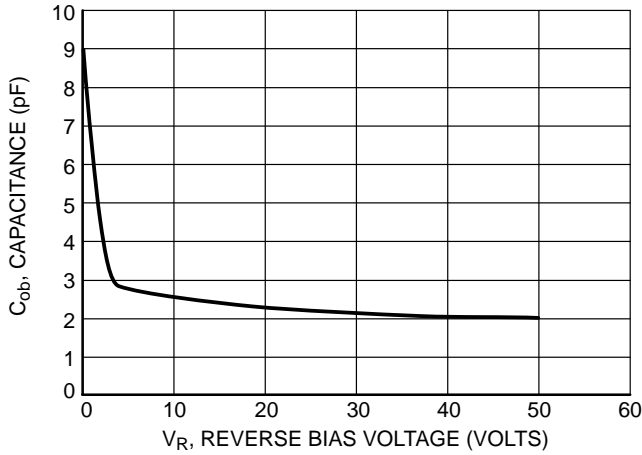

Figure 25. Output Capacitance

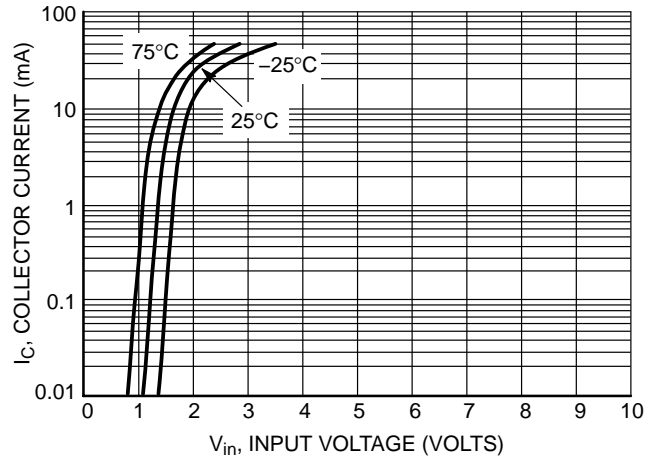

Figure 26. Output Current versus Input Voltage

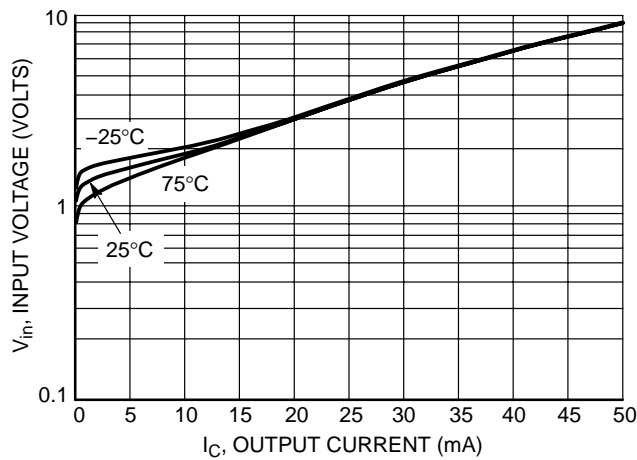

Figure 27. Input Voltage versus Output Current

MUN511T1 Series

TYPICAL ELECTRICAL CHARACTERISTICS — MUN5136T1

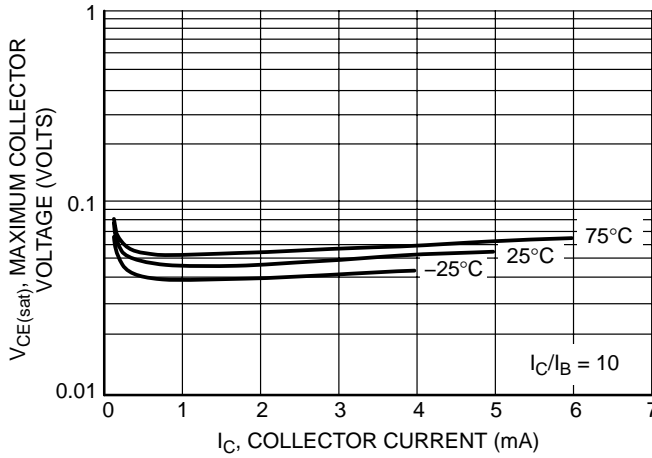

Figure 28. Maximum Collector Voltage versus Collector Current

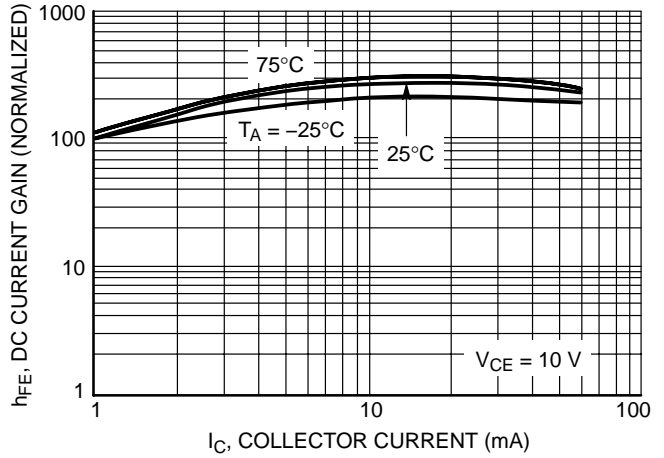

Figure 29. DC Current Gain

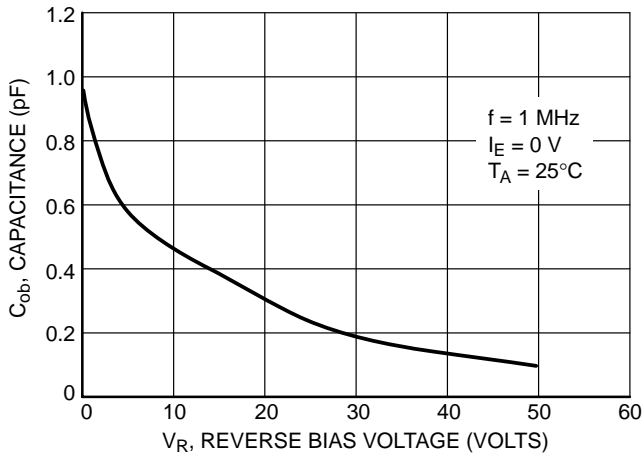

Figure 30. Output Capacitance

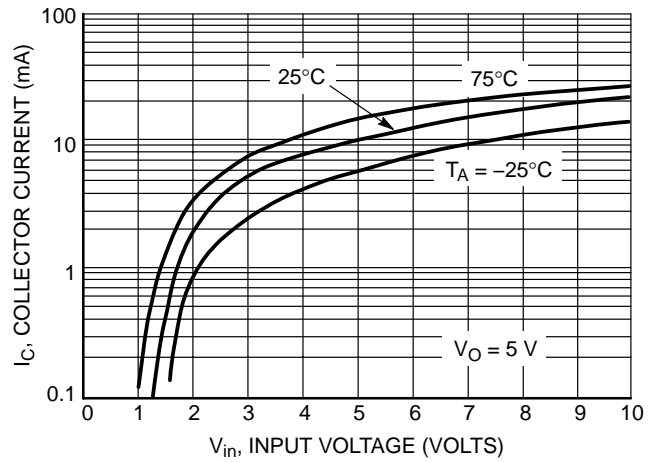

Figure 31. Output Current versus Input Voltage

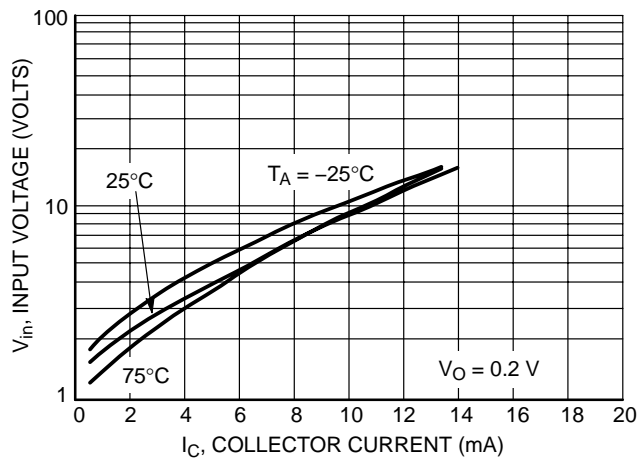

Figure 32. Input Voltage versus Output Current

MUN511T1 Series

TYPICAL ELECTRICAL CHARACTERISTICS — MUN5137T1

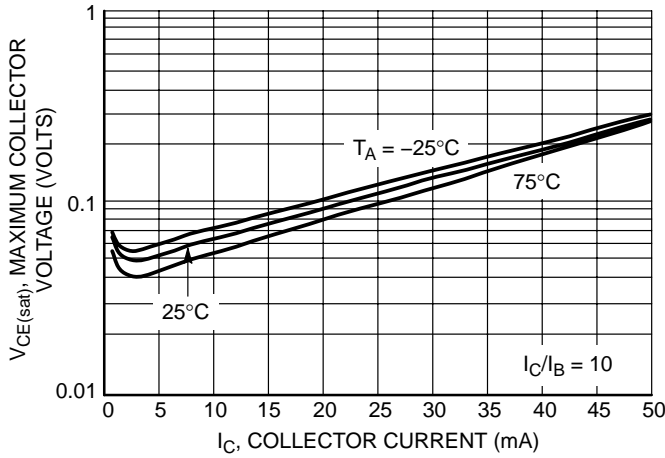

Figure 33. Maximum Collector Voltage versus Collector Current

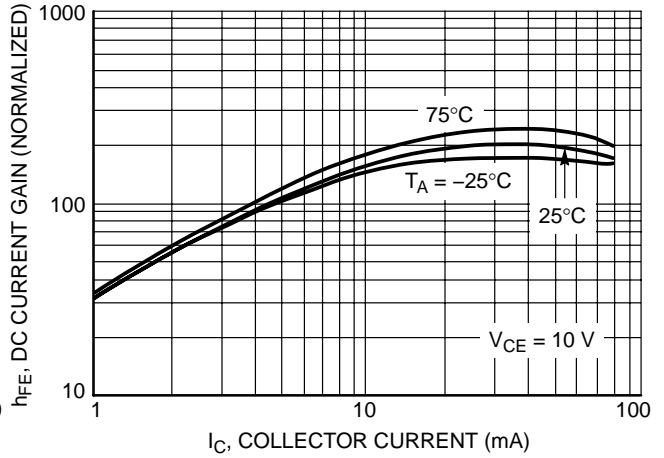

Figure 34. DC Current Gain

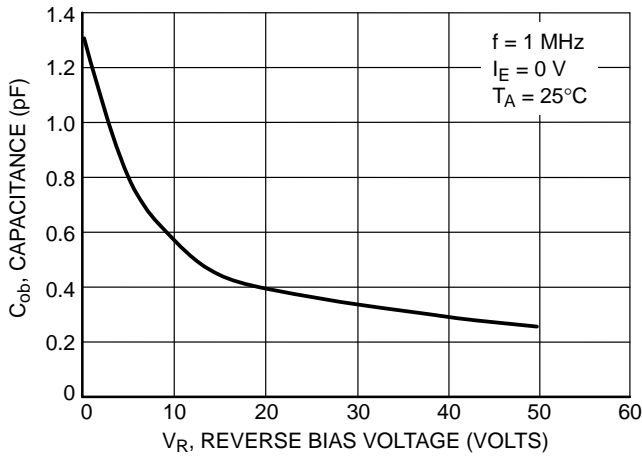

Figure 35. Output Capacitance

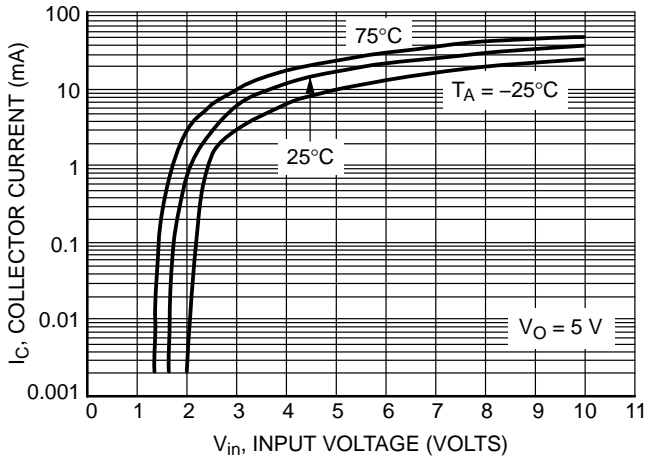

Figure 36. Output Current versus Input Voltage

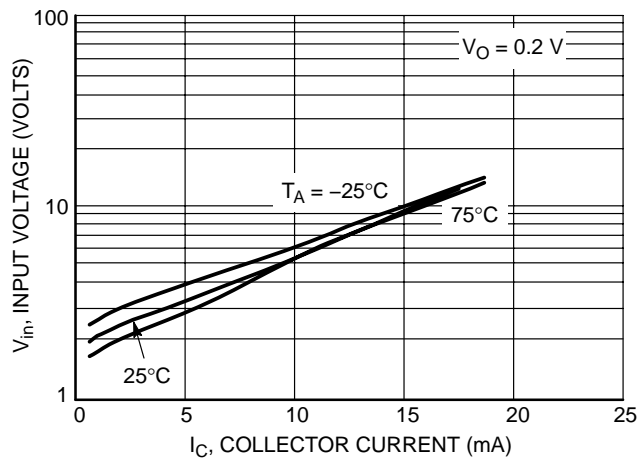
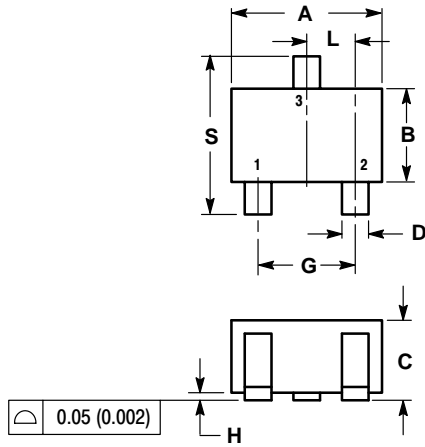

Figure 37. Input Voltage versus Output Current

MUN511T1 Series

PACKAGE DIMENSIONS

SC-70/SOT-323
CASE 419-04
ISSUE L



NOTES:

1. DIMENSIONING AND TOLERANCING PER ANSI Y14.5M, 1982.
2. CONTROLLING DIMENSION: INCH.

| DIM | INCHES | | MILLIMETERS | |
|-----|-----------|-------|-------------|------|
| | MIN | MAX | MIN | MAX |
| A | 0.071 | 0.087 | 1.80 | 2.20 |
| B | 0.045 | 0.053 | 1.15 | 1.35 |
| C | 0.032 | 0.040 | 0.80 | 1.00 |
| D | 0.012 | 0.016 | 0.30 | 0.40 |
| G | 0.047 | 0.055 | 1.20 | 1.40 |
| H | 0.000 | 0.004 | 0.00 | 0.10 |
| J | 0.004 | 0.010 | 0.10 | 0.25 |
| K | 0.017 REF | | 0.425 REF | |
| L | 0.026 BSC | | 0.650 BSC | |
| N | 0.028 REF | | 0.700 REF | |
| S | 0.079 | 0.095 | 2.00 | 2.40 |

- STYLE 3:
PIN 1. BASE
2. EMITTER
3. COLLECTOR

SOLDERING FOOTPRINT*

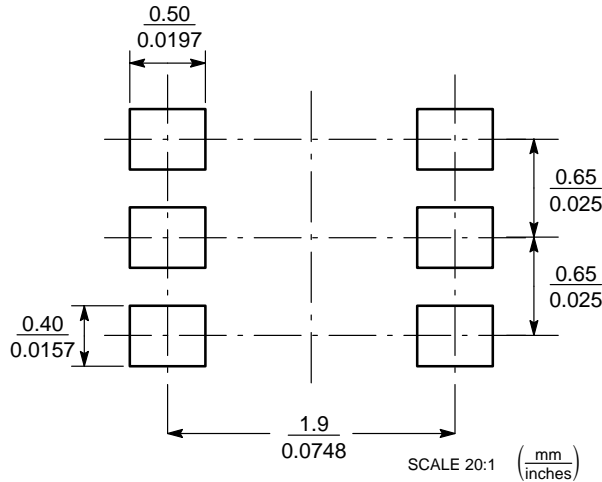

*For additional information on our Pb-Free strategy and soldering details, please download the ON Semiconductor Soldering and Mounting Techniques Reference Manual, SOLDERRM/D.

ON Semiconductor and are registered trademarks of Semiconductor Components Industries, LLC (SCILLC). SCILLC reserves the right to make changes without further notice to any products herein. SCILLC makes no warranty, representation or guarantee regarding the suitability of its products for any particular purpose, nor does SCILLC assume any liability arising out of the application or use of any product or circuit, and specifically disclaims any and all liability, including without limitation special, consequential or incidental damages. "Typical" parameters which may be provided in SCILLC data sheets and/or specifications can and do vary in different applications and actual performance may vary over time. All operating parameters, including "Typicals" must be validated for each customer application by customer's technical experts. SCILLC does not convey any license under its patent rights nor the rights of others. SCILLC products are not designed, intended, or authorized for use as components in systems intended for surgical implant into the body, or other applications intended to support or sustain life, or for any other application in which the failure of the SCILLC product could create a situation where personal injury or death may occur. Should Buyer purchase or use SCILLC products for any such unintended or unauthorized application, Buyer shall indemnify and hold SCILLC and its officers, employees, subsidiaries, affiliates, and distributors harmless against all claims, costs, damages, and expenses, and reasonable attorney fees arising out of, directly or indirectly, any claim of personal injury or death associated with such unintended or unauthorized use, even if such claim alleges that SCILLC was negligent regarding the design or manufacture of the part. SCILLC is an Equal Opportunity/Affirmative Action Employer. This literature is subject to all applicable copyright laws and is not for resale in any manner.

PUBLICATION ORDERING INFORMATION

LITERATURE FULFILLMENT:
Literature Distribution Center for ON Semiconductor
P.O. Box 61312, Phoenix, Arizona 85082-1312 USA
Phone: 480-829-7710 or 800-344-3860 Toll Free USA/Canada
Fax: 480-829-7709 or 800-344-3867 Toll Free USA/Canada
Email: orderlit@onsemi.com

N. American Technical Support: 800-282-9855 Toll Free USA/Canada

Japan: ON Semiconductor, Japan Customer Focus Center
2-9-1 Kamimeguro, Meguro-ku, Tokyo, Japan 153-0051
Phone: 81-3-5773-3850

ON Semiconductor Website: <http://onsemi.com>

Order Literature: <http://www.onsemi.com/litorder>

For additional information, please contact your local Sales Representative.

Copyright © Each Manufacturing Company.

All Datasheets cannot be modified without permission.

This datasheet has been download from :

www.AllDataSheet.com

100% Free DataSheet Search Site.

Free Download.

No Register.

Fast Search System.

www.AllDataSheet.com