

19-0096 Rev 1; 8/94

MAXIM

Low-Noise, Precision Op Amp

MXL1007

General Description

The Maxim MXL1007 operational amplifier features low-noise, $\pm 15\text{V}$ performance: $2.5\text{nV}/\sqrt{\text{Hz}}$ wideband noise, $1/\text{f}$ corner frequency of 2Hz , and 60nVp-p 0.1Hz to 10Hz noise. Precision and speed performance includes $10\mu\text{V}$ typical offset voltage, $0.2\mu\text{V}/^\circ\text{C}$ drift, 130dB CMRR and PSRR, and an 8MHz unity-gain stable bandwidth. In addition, the MXL1007's voltage gain is 20 million with a $2\text{k}\Omega$ load and 12 million with a 600Ω load.

Maxim's MXL1007 is a pin-compatible alternative to other industry-standard low-noise op amps such as the OP27 and LT1007.

For applications requiring higher performance, see the MAX427/MAX437 and MAX410/MAX412/MAX414 data sheets.

Applications

- Low-Noise Signal Processing
- Threshold Detection
- Strain-Gauge Amplifiers
- Microphone Preamplifiers

Features

- ◆ **Low-Noise Performance:**
 $4.5\text{nV}/\sqrt{\text{Hz}}$ Max (10Hz)
 $3.8\text{nV}/\sqrt{\text{Hz}}$ Max (1kHz)
- ◆ **High-Voltage Gain:**
 7 Million Min ($2\text{k}\Omega$ Load)
 3 Million Min (600Ω Load)
- ◆ **25 μV Max Offset Voltage**
- ◆ **0.6 $\mu\text{V}/^\circ\text{C}$ Max Drift**
- ◆ **117dB Min CMRR**

Ordering Information

PART	TEMP. RANGE	PIN-PACKAGE
MXL1007ACN8	0°C to $+70^\circ\text{C}$	8 Plastic DIP
MXL1007CN8	0°C to $+70^\circ\text{C}$	8 Plastic DIP
MXL1007CS8	0°C to $+70^\circ\text{C}$	8 SO
MXL1007CS	0°C to $+70^\circ\text{C}$	16 Wide SO
MXL1007AMJ8	-55°C to $+125^\circ\text{C}$	8 CERDIP
MXL1007MJ8	-55°C to $+125^\circ\text{C}$	8 CERDIP
MXL1007AMH	-55°C to $+125^\circ\text{C}$	8 TO-99
MXL1007MH	-55°C to $+125^\circ\text{C}$	8 TO-99

Typical Application Circuit

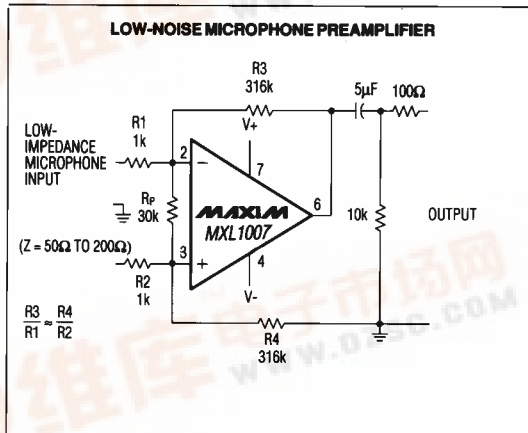

Pin Configurations

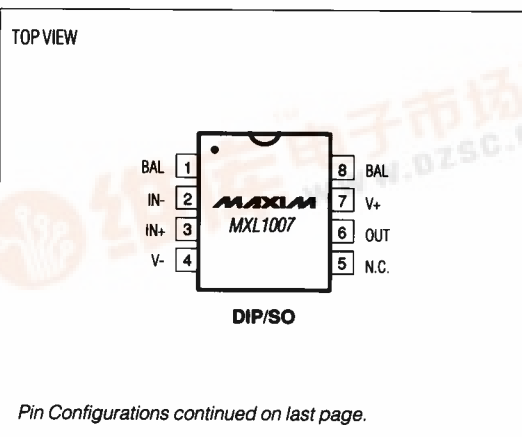

Low-Noise, Precision Op Amp

ABSOLUTE MAXIMUM RATINGS

Supply Voltage.....	±22V	8-Pin CERDIP (derate 8.00mW/°C above +70°C).....	640mW
Input Voltage (Note 1).....	±22V	8-Pin TO-99 (derate 6.67mW/°C above +70°C).....	533mW
Output Short-Circuit Duration.....	Continuous	Operating Temperature Ranges:	
Differential Input Voltage (Note 2).....	±0.7V	MXL1007AC_/C_.....	0°C to +70°C
Differential Input Current (Note 2).....	±25mA	MXL1007AM_/M_.....	-55°C to +125°C
Continuous Power Dissipation (T _A = +70°C)		Junction Temperature Range.....	-65°C to +150°C
8-Pin Plastic DIP (derate 9.09mW/°C above +70°C) ...	727mW	Storage Temperature Range.....	-65°C to +150°C
8-Pin SO (derate 5.88mW/°C above +70°C).....	471mW	Lead Temperature (soldering, 10sec).....	+300°C
16-Pin Wide SO (derate 9.52mW/°C above +70°C)	726mW		

Note 1: For supply voltages less than ±22V, the absolute maximum input voltage is equal to the supply voltage.

Note 2: MXL1007 inputs are protected by back-to-back diodes. Current-limiting resistors are not used in order to achieve low noise. If differential input voltage exceeds ±0.7V, the input current should be limited to 25mA.

Stresses beyond those listed under "Absolute Maximum Ratings" may cause permanent damage to the device. These are stress ratings only, and functional operation of the device at these or any other conditions beyond those indicated in the operational sections of the specifications is not implied. Exposure to absolute maximum rating conditions for extended periods may affect device reliability.

ELECTRICAL CHARACTERISTICS

(V_S = ±15V, T_A = +25°C, unless otherwise noted.)

PARAMETER	SYMBOL	CONDITIONS	MXL1007AM/AC			MXL1007M/C			UNITS
			MIN	TYP	MAX	MIN	TYP	MAX	
Input Offset Voltage (Note 3)	V _{OS}		10	25		20	60		μV
Long-Term V _{OS} Stability (Notes 4, 5)	V _{OS} /TIME		0.2	1.0		0.2	1.0		μV/Mo
Input Bias Current	I _B		±10	±35		±15	±55		nA
Input Offset Current	I _{OS}		7	30		12	50		nA
Input Voltage Range	I _{VR}		±11.0	±12.5		±11.0	±12.5		V
Input Resistance – Common Mode	R _{INCM}		7			5			GΩ
Input Noise Voltage (Notes 5, 6)	e _{np-p}	0.1Hz to 10Hz	0.06	0.13		0.06	0.13		μV _{p-p}
Input Noise-Voltage Density (Note 5)	e _n	f _o = 10Hz	2.8	4.5		2.8	4.5		nV/√Hz
		f _o = 1kHz	2.5	3.8		2.5	3.8		
Input Noise-Current Density (Notes 5, 7)	i _n	f _o = 10Hz	1.5	4.0		1.5	4.0		pA/√Hz
		f _o = 1kHz	0.4	0.6		0.4	0.6		
Large-Signal Voltage Gain	A _{VO}	R _L ≥ 2kΩ, V _O = ±12V	7.0	20.0		5.0	20.0		V/μV
		R _L ≥ 1kΩ, V _O = ±10V	5.0	16.0		3.5	16.0		
		R _L ≥ 600Ω, V _O = ±10V	3.0	12.0		2.0	12.0		
Output Voltage Swing	V _O	R _L ≥ 2kΩ	±13.0	±13.8		±12.5	±13.5		V
		R _L ≥ 600Ω	±11.0	±12.5		±10.5	±12.5		
Open-Loop Output Resistance	R _O	V _O = 0, I _O = 0	70			70			Ω
Common-Mode Rejection Ratio	CMRR	V _{CM} = ±11V	117	130		110	126		dB
Power-Supply Rejection Ratio	PSRR	V _S = ±4V to ±18V	110	130		106	126		dB
Gain-Bandwidth Product (Note 5)	GBP	f _o = 100kHz	5.0	8.0		5.0	8.0		MHz
Slew Rate (Note 5)	SR	R _L ≥ 2kΩ	1.7	2.5		1.7	2.5		V/μs
Power Dissipation	PD	V _O = 0	80	120		80	140		mW

Low-Noise, Precision Op Amp

MXL1007

ELECTRICAL CHARACTERISTICS

($V_S = \pm 15V$, $T_A = -55^\circ C$ to $+125^\circ C$, unless otherwise noted.)

PARAMETER	SYMBOL	CONDITIONS	MXL1007AM			MXL1007M			UNITS
			MIN	TYP	MAX	MIN	TYP	MAX	
Input Offset Voltage (Note 3)	V_{OS}		25	60		50	160	μV	
Average Offset-Voltage Drift (Note 8)	TCV_{OS}		0.2	0.6		0.3	1.0	$\mu V/^\circ C$	
Input Offset Current	I_{OS}		15	50		20	85	nA	
Input Bias Current	I_B		± 20	± 60		± 35	± 95	nA	
Input Voltage Range	I_{VR}		± 10.3	± 11.5		± 10.3	± 11.5	V	
Common-Mode Rejection Ratio	CMRR	$V_{CM} = \pm 10.3V$	112	126		104	120	dB	
Power-Supply Rejection Ratio	PSRR	$V_S = \pm 4.5V$ to $\pm 18V$	104	126		100	120	dB	
Large-Signal Voltage Gain	A_{VOL}	$R_L \geq 2k\Omega$, $V_O = \pm 10V$	3.0	14.0		2.0	14.0	$V/\mu V$	
		$R_L \geq 1k\Omega$, $V_O = \pm 10V$	2.0	10.0		1.5	10.0		
Maximum Output-Voltage Swing	V_{OUT}	$R_L \geq 2k\Omega$	± 12.5	± 13.5		± 12.0	± 13.5	V	
Power Dissipation	PD	$V_O = 0$	100	150		100	170	mW	

ELECTRICAL CHARACTERISTICS

($V_S = \pm 15V$, $T_A = 0^\circ C$ to $+70^\circ C$, unless otherwise noted.)

PARAMETER	SYMBOL	CONDITIONS	MXL1007AC			MXL1007C			UNITS
			MIN	TYP	MAX	MIN	TYP	MAX	
Input Offset Voltage (Note 3)	V_{OS}		20	50		35	110	μV	
Average Offset-Voltage Drift (Note 8)	TCV_{OS}		0.2	0.6		0.3	1.0	$\mu V/^\circ C$	
Input Offset Current	I_{OS}		10	40		15	70	nA	
Input Bias Current	I_B		± 14	± 45		± 20	± 75	nA	
Input Voltage Range	I_{VR}		± 10.5	± 11.8		± 10.5	± 11.8	V	
Common-Mode Rejection Ratio	CMRR	$V_{CM} = \pm 10.5V$	114	126		106	120	dB	
Power-Supply Rejection Ratio	PSRR	$V_S = \pm 4.5V$ to $\pm 18V$	106	126		102	120	dB	
Large-Signal Voltage Gain	A_{VOL}	$R_L \geq 2k\Omega$, $V_O = \pm 10V$	4.0	18.0		2.5	18.0	$V/\mu V$	
		$R_L \geq 1k\Omega$, $V_O = \pm 10V$	2.5	14.0		2.0	14.0		
Maximum Output-Voltage Swing	V_{OUT}	$R_L \geq 2k\Omega$	± 12.5	± 13.6		± 12.0	± 13.6	V	
Power Dissipation	PD	$V_O = 0$	90	144		90	160	mW	

Note 3: Input Offset Voltage measurements are performed by automatic test equipment approximately 0.5 sec after application of power.

Note 4: Long-Term Input Offset Voltage Stability refers to the average trend line of Offset Voltage vs. Time over extended periods after the first 30 days of operation. Excluding the initial hour of operation, changes in V_{OS} during the first 30 days are typically $2.5\mu V$.

Note 5: This parameter is guaranteed by design and is not tested.

Note 6: See the test circuit for 0.1Hz to 10Hz tester in the *Typical Operating Characteristics* section.

Note 7: See the test circuit for current noise measurement in the *Applications Information* section.

Note 8: The Average Input Offset Drift performance is within the specifications unnull or when nulled with a pot having a range of $8k\Omega$ to $20k\Omega$. AM and AC grades are sample tested to 0.1% AQL. C grade is guaranteed by design.

Low-Noise, Precision Op Amp

Typical Operating Characteristics

(TA = +25°C, unless otherwise noted)

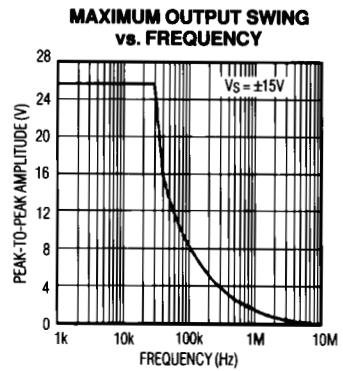
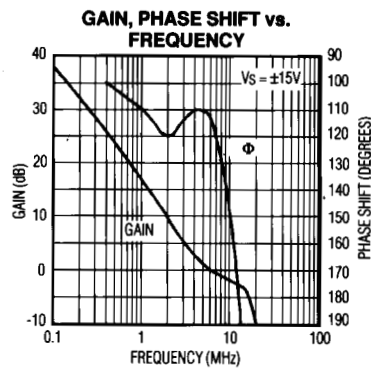
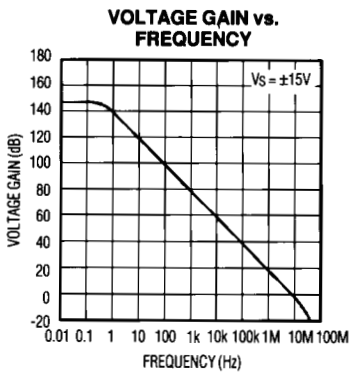
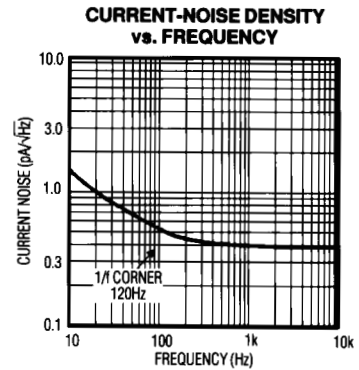
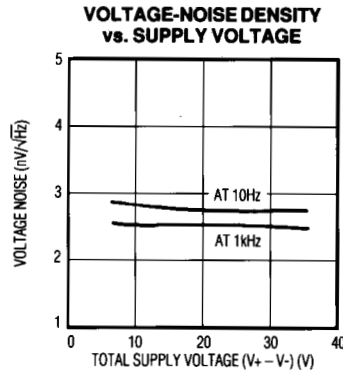
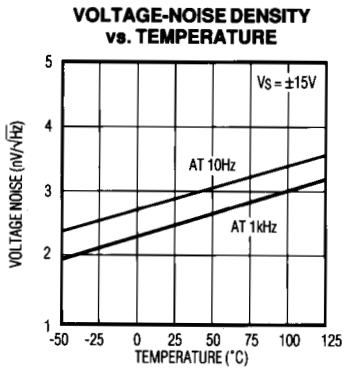
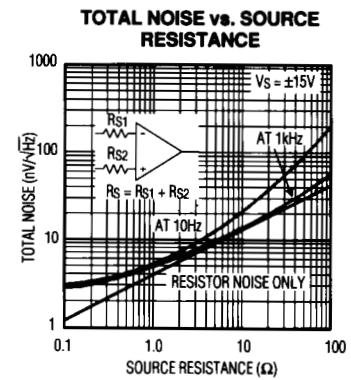
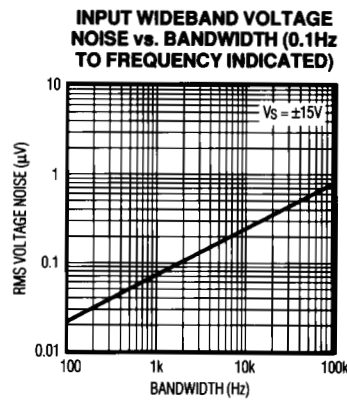
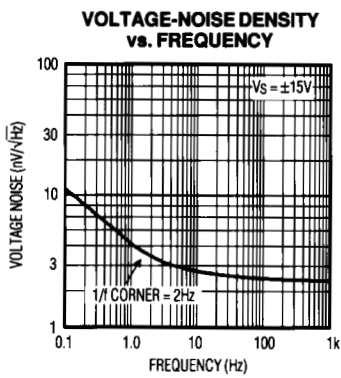

Low-Noise, Precision Op Amp

Typical Operating Characteristics (continued)

MAX9211

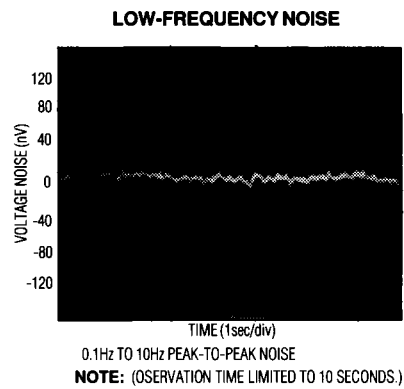
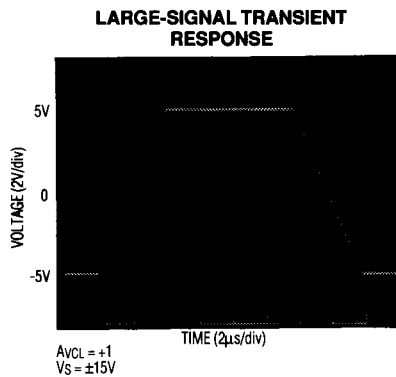
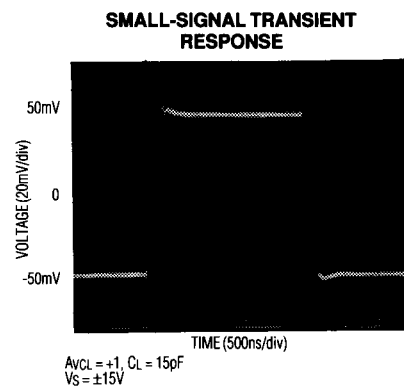
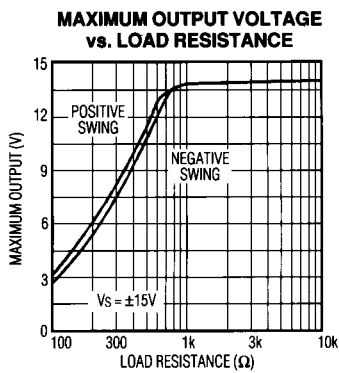

Low-Noise, Precision Op Amp

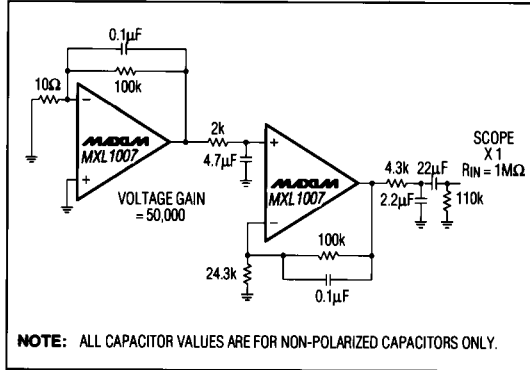

Figure 1. Voltage-Noise Test Circuit (0.1Hz to 10Hz)

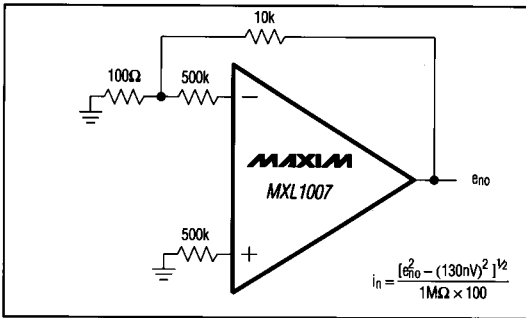

Figure 2. Current-Noise Test Circuit

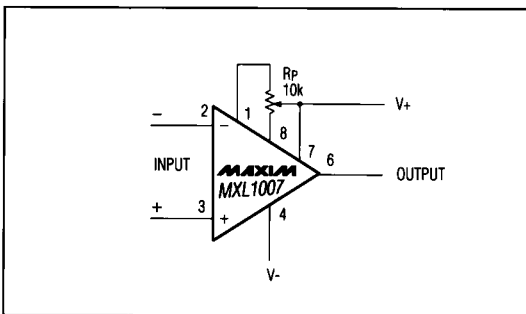
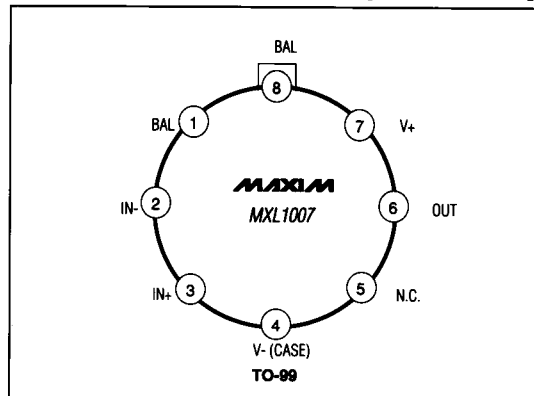
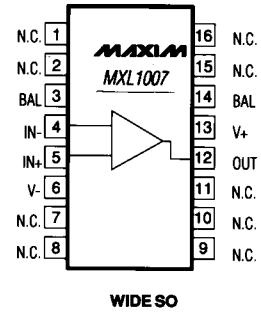

Figure 3. Offset Nulling Circuit

Pin Configurations (continued)



TOP VIEW



Low-Noise, Precision Op Amp

Package Information

MXL1007

**Plastic DIP
PLASTIC
DUAL-IN-LINE
PACKAGE
(0.300 in.)**

DIM	INCHES		MILLIMETERS	
	MIN	MAX	MIN	MAX
A	—	0.200	—	5.08
A1	0.015	—	0.38	—
A2	0.125	0.175	3.18	4.45
A3	0.055	0.080	1.40	2.03
B	0.016	0.022	0.41	0.56
B1	0.045	0.065	1.14	1.65
C	0.008	0.012	0.20	0.30
D1	0.005	0.080	0.13	2.03
E	0.300	0.325	7.62	8.26
E1	0.240	0.310	6.10	7.87
e	0.100	—	2.54	—
eA	0.300	—	7.62	—
eB	—	0.400	—	10.16
L	0.115	0.150	2.92	3.81

PKG.	DIM	PINS	INCHES		MILLIMETERS	
			MIN	MAX	MIN	MAX
P	D	8	0.348	0.390	8.84	9.91
P	D	14	0.735	0.765	18.67	19.43
P	D	16	0.745	0.765	18.92	19.43
P	D	18	0.885	0.915	22.48	23.24
P	D	20	1.015	1.045	25.78	26.54
N	D	24	1.14	1.265	28.96	32.13

21-0043A

**Narrow SO
SMALL-OUTLINE
PACKAGE
(0.150 in.)**

DIM	INCHES		MILLIMETERS	
	MIN	MAX	MIN	MAX
A	0.053	0.069	1.35	1.75
A1	0.004	0.010	0.10	0.25
B	0.014	0.019	0.35	0.49
C	0.007	0.010	0.19	0.25
E	0.150	0.157	3.80	4.00
e	0.050		1.27	
H	0.228	0.244	5.80	6.20
L	0.016	0.050	0.40	1.27

DIM	PINS	INCHES		MILLIMETERS	
		MIN	MAX	MIN	MAX
D	8	0.189	0.197	4.80	5.00
D	14	0.337	0.344	8.55	8.75
D	16	0.386	0.394	9.80	10.00

21-0041A

Package Information (continued)

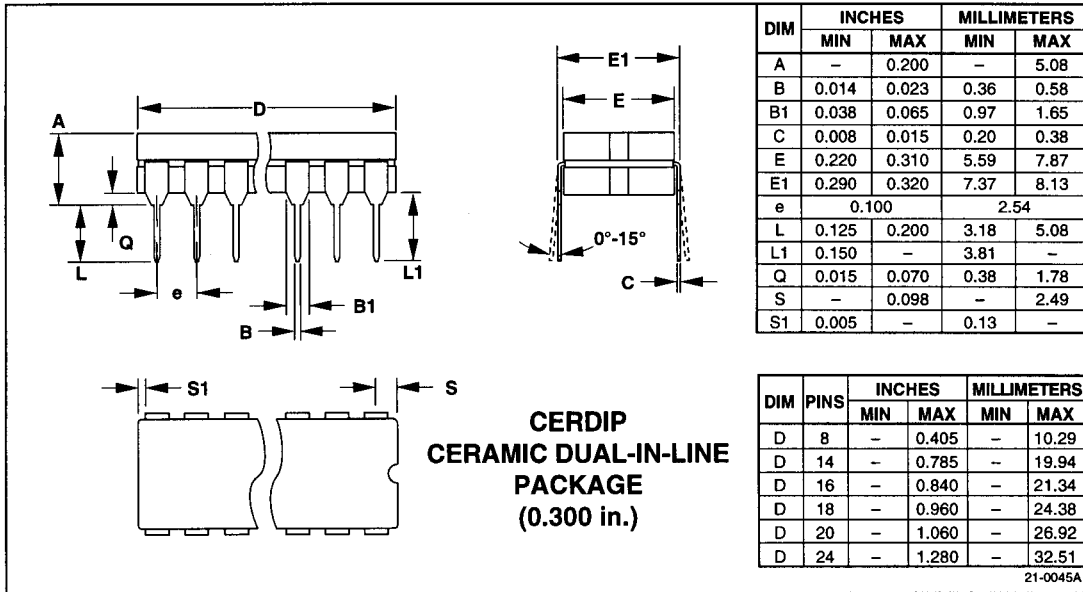

Maxim cannot assume responsibility for use of any circuitry other than circuitry entirely embodied in a Maxim product. No circuit patent licenses are implied. Maxim reserves the right to change the circuitry and specifications without notice at any time.

8 **Maxim Integrated Products, 120 San Gabriel Drive, Sunnyvale, CA 94086 (408) 737-7600**