



# LM2672 SIMPLE SWITCHER® Power Converter High Efficiency 1A Step-Down Voltage Regulator with Features

## General Description

The LM2672 series of regulators are monolithic integrated circuits built with a LDMOS process. These regulators provide all the active functions for a step-down (buck) switching regulator, capable of driving a 1A load current with excellent line and load regulation. These devices are available in fixed output voltages of 3.3V, 5.0V, 12V, and an adjustable output version.

Requiring a minimum number of external components, these regulators are simple to use and include patented internal frequency compensation (Patent Nos. 5,382,918 and 5,514,947), fixed frequency oscillator, external shutdown, soft-start, and frequency synchronization.

The LM2672 series operates at a switching frequency of 260 kHz, thus allowing smaller sized filter components than what would be needed with lower frequency switching regulators. Because of its very high efficiency (>90%), the copper traces on the printed circuit board are the only heat sinking needed.

A family of standard inductors for use with the LM2672 are available from several different manufacturers. This feature greatly simplifies the design of switch-mode power supplies using these advanced ICs. Also included in the datasheet are selector guides for diodes and capacitors designed to work in switch-mode power supplies.

Other features include a guaranteed  $\pm 1.5\%$  tolerance on output voltage within specified input voltages and output load conditions, and  $\pm 10\%$  on the oscillator frequency. External shutdown is included, featuring typically 50  $\mu\text{A}$  stand-by current. The output switch includes current limiting, as well as thermal shutdown for full protection under fault conditions.

To simplify the LM2672 buck regulator design procedure, there exists computer design software, **LM267X Made Simple** version 1.0.

## Features

- Efficiency up to 96%
- Available in SO-8 and 8-pin DIP packages
- Computer Design Software **LM267X Made Simple** version 1.0
- Simple and easy to design with
- Requires only 5 external components
- Uses readily available standard inductors
- 3.3V, 5.0V, 12V, and adjustable output versions
- Adjustable version output voltage range: 1.21V to 37V
- $\pm 1.5\%$  max output voltage tolerance over line and load conditions
- Guaranteed 1A output load current
- 0.25 $\Omega$  DMOS Output Switch
- Wide input voltage range: 8V to 40V
- 260 kHz fixed frequency internal oscillator
- TTL shutdown capability, low power standby mode
- Soft-start and frequency synchronization
- Thermal shutdown and current limit protection

## Typical Applications

- Simple High Efficiency (>90%) Step-Down (Buck) Regulator
- Efficient Pre-Regulator for Linear Regulators

## Typical Application (Fixed Output Voltage Versions)

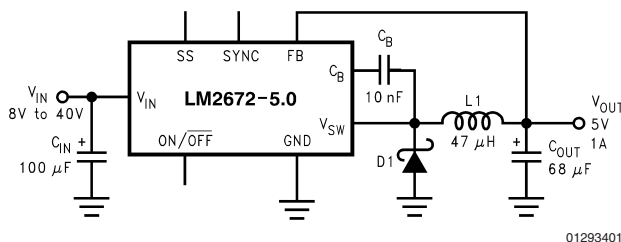

SIMPLE SWITCHER® is a registered trademark of National Semiconductor Corporation.  
Windows® is a registered trademark of Microsoft Corporation.

**Absolute Maximum Ratings** (Note 1)

If Military/Aerospace specified devices are required, please contact the National Semiconductor Sales Office/Distributors for availability and specifications.

Supply Voltage	45V
ON/OFF Pin Voltage	$-0.1V \leq V_{SH} \leq 6V$
Switch Voltage to Ground	-1V
Boost Pin Voltage	$V_{SW} + 8V$
Feedback Pin Voltage	$-0.3V \leq V_{FB} \leq 14V$
ESD Susceptibility	
Human Body Model (Note 2)	2 kV
Power Dissipation	Internally Limited

Storage Temperature Range	-65°C to +150°C
Lead Temperature	
M Package	
Vapor Phase (60s)	+215°C
Infrared (15s)	+220°C
N Package (Soldering, 10s)	+260°C
Maximum Junction Temperature	+150°C

**Operating Ratings**

Supply Voltage	6.5V to 40V
Temperature Range	$-40^{\circ}\text{C} \leq T_J \leq +125^{\circ}\text{C}$

**Electrical Characteristics** Specifications with standard type face are for  $T_J = 25^{\circ}\text{C}$ , and those in **bold type face** apply over full Operating Temperature Range.

**LM2672-3.3**

Symbol	Parameter	Conditions	Typical (Note 4)	Min (Note 5)	Max (Note 5)	Units
<b>SYSTEM PARAMETERS</b> Test Circuit <i>Figure 2</i> (Note 3)						
$V_{OUT}$	Output Voltage	$V_{IN} = 8V$ to 40V, $I_{LOAD} = 20$ mA to 1A	3.3	3.251/ <b>3.201</b>	3.350/ <b>3.399</b>	V
$V_{OUT}$	Output Voltage	$V_{IN} = 6.5V$ to 40V, $I_{LOAD} = 20$ mA to 500 mA	3.3	3.251/ <b>3.201</b>	3.350/ <b>3.399</b>	V
$\eta$	Efficiency	$V_{IN} = 12V$ , $I_{LOAD} = 1A$	86			%

**LM2672-5.0**

Symbol	Parameter	Conditions	Typical (Note 4)	Min (Note 5)	Max (Note 5)	Units
<b>SYSTEM PARAMETERS</b> Test Circuit <i>Figure 2</i> (Note 3)						
$V_{OUT}$	Output Voltage	$V_{IN} = 8V$ to 40V, $I_{LOAD} = 20$ mA to 1A	5.0	4.925/ <b>4.850</b>	5.075/ <b>5.150</b>	V
$V_{OUT}$	Output Voltage	$V_{IN} = 6.5V$ to 40V, $I_{LOAD} = 20$ mA to 500 mA	5.0	4.925/ <b>4.850</b>	5.075/ <b>5.150</b>	V
$\eta$	Efficiency	$V_{IN} = 12V$ , $I_{LOAD} = 1A$	90			%

**LM2672-12**

Symbol	Parameter	Conditions	Typical (Note 4)	Min (Note 5)	Max (Note 5)	Units
<b>SYSTEM PARAMETERS</b> Test Circuit <i>Figure 2</i> (Note 3)						
$V_{OUT}$	Output Voltage	$V_{IN} = 15V$ to 40V, $I_{LOAD} = 20$ mA to 1A	12	11.82/ <b>11.64</b>	12.18/ <b>12.36</b>	V
$\eta$	Efficiency	$V_{IN} = 24V$ , $I_{LOAD} = 1A$	94			%

**LM2672-ADJ**

Symbol	Parameter	Conditions	Typ (Note 4)	Min (Note 5)	Max (Note 5)	Units
<b>SYSTEM PARAMETERS</b> Test Circuit <i>Figure 3</i> (Note 3)						
$V_{FB}$	Feedback Voltage	$V_{IN} = 8V$ to 40V, $I_{LOAD} = 20$ mA to 1A  $V_{OUT}$ Programmed for 5V (see Circuit of <i>Figure 3</i> )	1.210	1.192/ <b>1.174</b>	1.228/ <b>1.246</b>	V
$V_{FB}$	Feedback Voltage	$V_{IN} = 6.5V$ to 40V, $I_{LOAD} = 20$ mA to 500 mA  $V_{OUT}$ Programmed for 5V (see Circuit of <i>Figure 3</i> )	1.210	1.192/ <b>1.174</b>	1.228/ <b>1.246</b>	V

## LM2672-ADJ (Continued)

Symbol	Parameter	Conditions	Typ (Note 4)	Min (Note 5)	Max (Note 5)	Units
$\eta$	Efficiency	$V_{IN} = 12V, I_{LOAD} = 1A$	90			%

## All Output Voltage Versions

## Electrical Characteristics

Specifications with standard type face are for  $T_J = 25^\circ C$ , and those in **bold type face** apply over **full Operating Temperature Range**. Unless otherwise specified,  $V_{IN} = 12V$  for the 3.3V, 5V, and Adjustable versions and  $V_{IN} = 24V$  for the 12V version, and  $I_{LOAD} = 100\text{ mA}$ .

Symbol	Parameters	Conditions	Typ	Min	Max	Units
<b>DEVICE PARAMETERS</b>						
$I_Q$	Quiescent Current	$V_{FEEDBACK} = 8V$ For 3.3V, 5.0V, and ADJ Versions	2.5		3.6	mA
		$V_{FEEDBACK} = 15V$ For 12V Versions	2.5			mA
$I_{STBY}$	Standby Quiescent Current	ON/OFF Pin = 0V	50		100/150	$\mu A$
$I_{CL}$	Current Limit		1.55	1.25/1.2	2.1/2.2	A
$I_L$	Output Leakage Current	$V_{IN} = 40V, ON/OFF\ Pin = 0V$ $V_{SWITCH} = 0V$	1		25	$\mu A$
		$V_{SWITCH} = -1V, ON/OFF\ Pin = 0V$	6		15	mA
$R_{DS(ON)}$	Switch On-Resistance	$I_{SWITCH} = 1A$	0.25		0.30/0.50	$\Omega$
$f_O$	Oscillator Frequency	Measured at Switch Pin	260	<b>225</b>	<b>275</b>	kHz
D	Maximum Duty Cycle		95			%
	Minimum Duty Cycle		0			%
$I_{BIAS}$	Feedback Bias Current	$V_{FEEDBACK} = 1.3V$ ADJ Version Only	85			nA
$V_{S/D}$	ON/OFF Pin Voltage Thresholds		1.4	<b>0.8</b>	<b>2.0</b>	V
$I_{S/D}$	ON/OFF Pin Current	ON/OFF Pin = 0V	20	<b>7</b>	<b>37</b>	$\mu A$
$F_{SYNC}$	Synchronization Frequency	$V_{SYNC} = 3.5V, 50\%$ duty cycle	400			kHz
$V_{SYNC}$	Synchronization Threshold Voltage		1.4			V
$V_{SS}$	Soft-Start Voltage		0.63	<b>0.53</b>	<b>0.73</b>	V
$I_{SS}$	Soft-Start Current		4.5	<b>1.5</b>	<b>6.9</b>	$\mu A$
$\theta_{JA}$	Thermal Resistance	N Package, Junction to Ambient (Note 6)	95			$^\circ C/W$
		M Package, Junction to Ambient (Note 6)	105			

**Note 1:** Absolute Maximum Ratings indicate limits beyond which damage to the device may occur. Operating Ratings indicate conditions for which the device is intended to be functional, but device parameter specifications may not be guaranteed under these conditions. For guaranteed specifications and test conditions, see the Electrical Characteristics.

**Note 2:** The human body model is a 100 pF capacitor discharged through a 1.5 k $\Omega$  resistor into each pin.

**Note 3:** External components such as the catch diode, inductor, input and output capacitors, and voltage programming resistors can affect switching regulator performance. When the LM2672 is used as shown in *Figure 2* and *Figure 3* test circuits, system performance will be as specified by the system parameters section of the Electrical Characteristics.

**Note 4:** Typical numbers are at 25 $^\circ C$  and represent the most likely norm.

**Note 5:** All limits guaranteed at room temperature (standard type face) and at **temperature extremes (bold type face)**. All room temperature limits are 100% production tested. All limits at **temperature extremes** are guaranteed via correlation using standard Statistical Quality Control (SQC) methods. All limits are used to calculate Average Outgoing Quality Level (AOQL).

**Note 6:** Junction to ambient thermal resistance with approximately 1 square inch of printed circuit board copper surrounding the leads. Additional copper area will lower thermal resistance further. See Application Information section in the application note accompanying this datasheet and the thermal model in **LM267X Made Simple** version 1.0 software.

## Connection Diagram

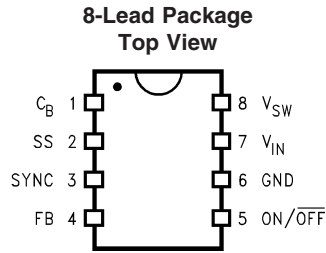

01293402

**For Surface Mount Package  
Order Number  
LM2672M-3.3, LM2672M-5.0,  
LM2672M-12 or LM2672M-ADJ  
See NSC Package Number M08A**

**For DIP Package  
Order Number  
LM2672N-3.3, LM2672N-5.0,  
LM2672N-12 or LM2672N-ADJ  
See NSC Package Number N08E**

## Typical Performance Characteristics

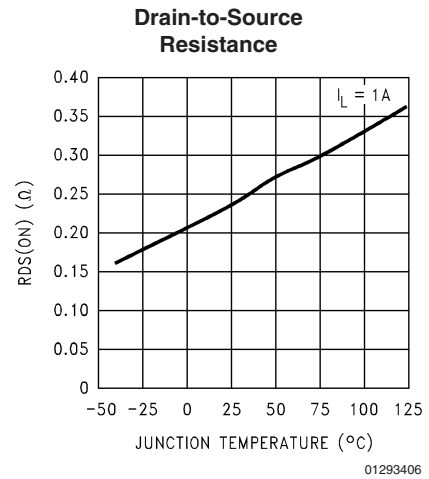
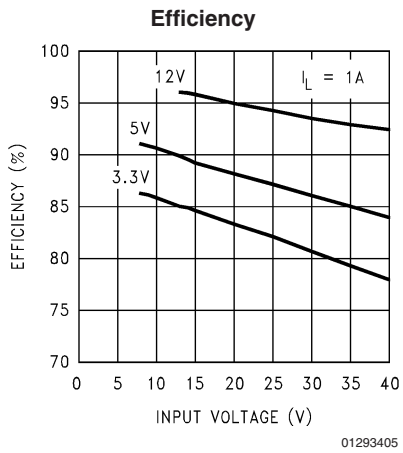
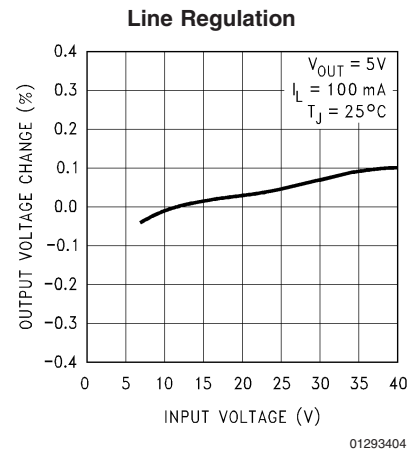
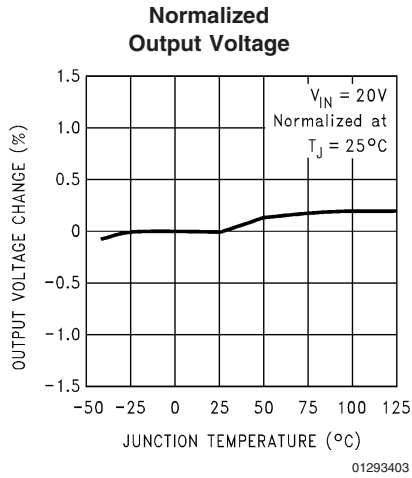

Typical Performance Characteristics (Continued)

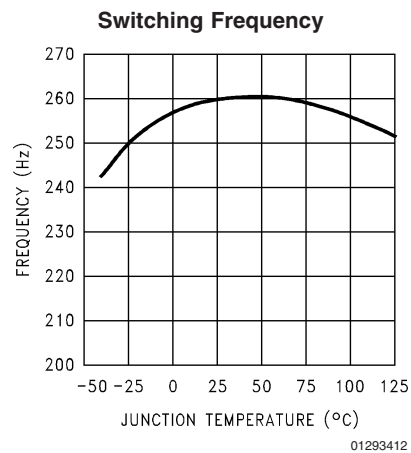
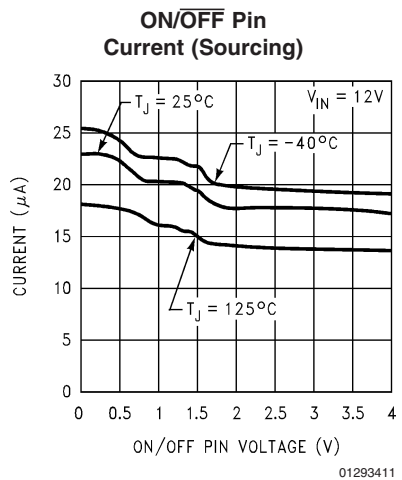
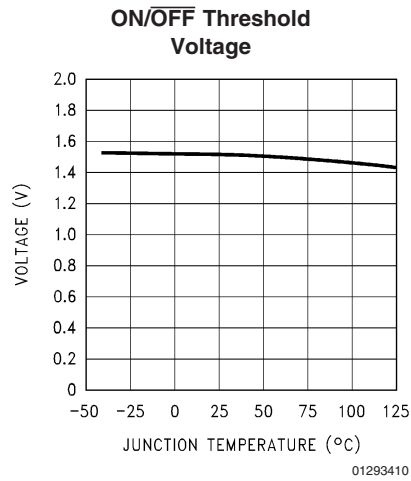
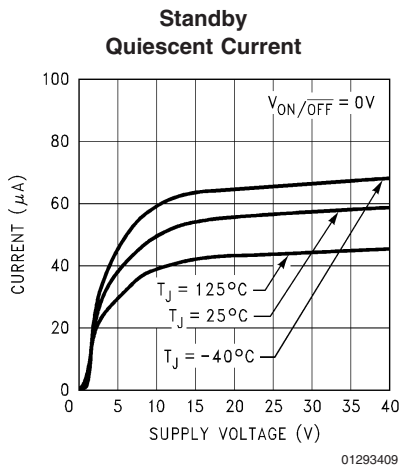
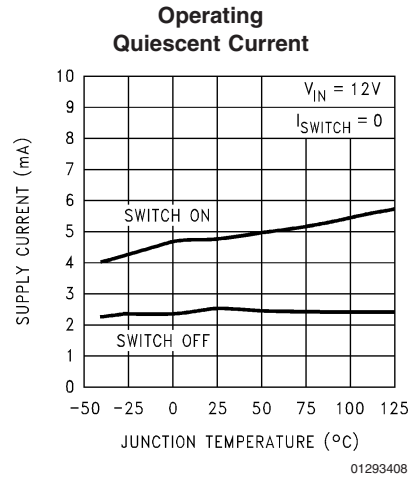
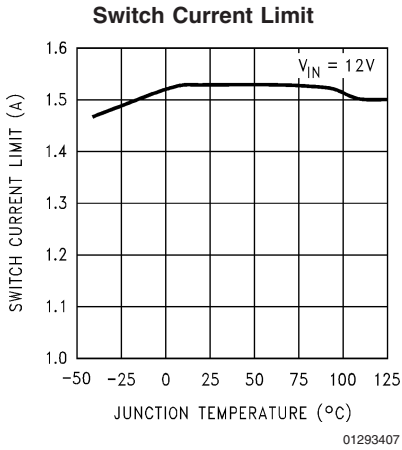

# Typical Performance Characteristics (Continued)

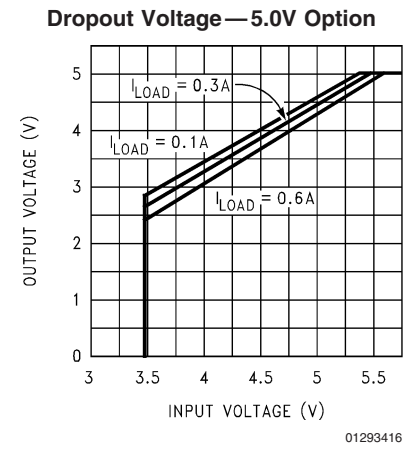
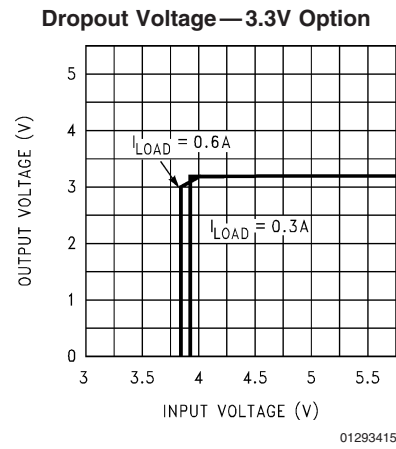
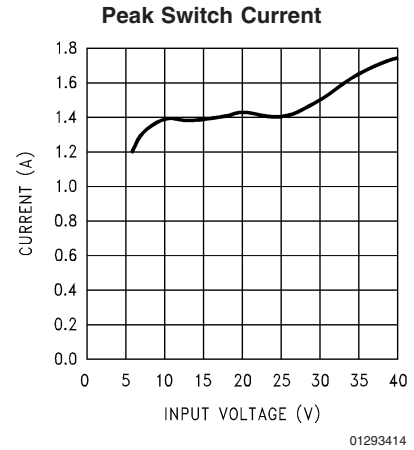
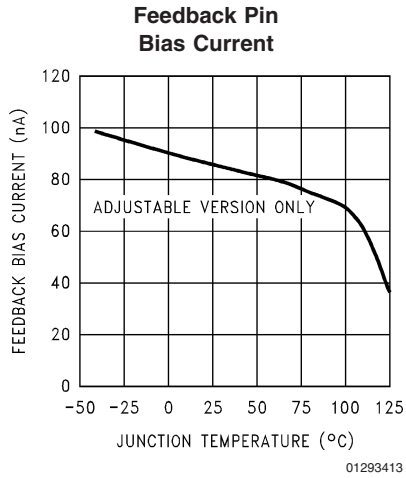

# Block Diagram

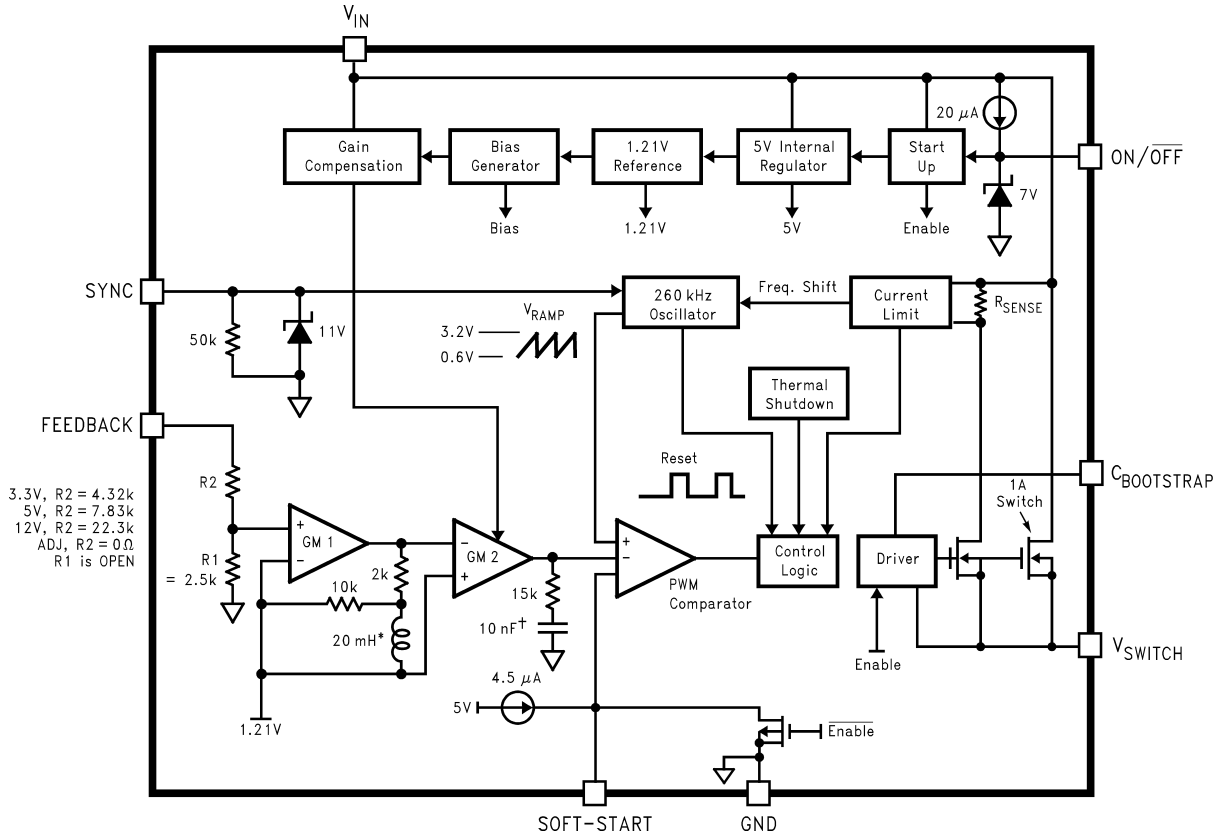

\* Patent Number 5,514,947  
 † Patent Number 5,382,918

01293417

FIGURE 1.

# Typical Performance Characteristics

(Circuit of Figure 2)

## Continuous Mode Switching Waveforms

$V_{IN} = 20V$ ,  $V_{OUT} = 5V$ ,  $I_{LOAD} = 1A$   
 $L = 47 \mu H$ ,  $C_{OUT} = 68 \mu F$ ,  $C_{OUT}ESR = 50 m\Omega$

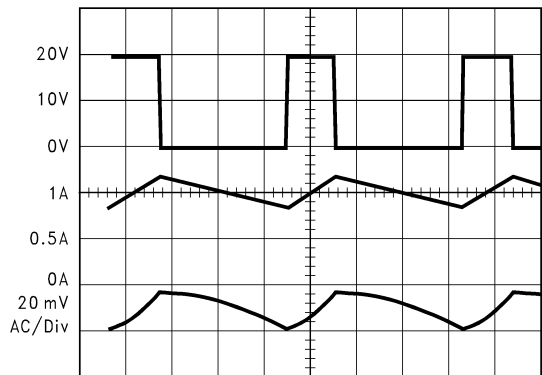

01293418

A:  $V_{SW}$  Pin Voltage, 10 V/div.  
 B: Inductor Current, 0.5 A/div  
 C: Output Ripple Voltage, 20 mV/div AC-Coupled

**Horizontal Time Base: 1  $\mu s$ /div**

## Discontinuous Mode Switching Waveforms

$V_{IN} = 20V$ ,  $V_{OUT} = 5V$ ,  $I_{LOAD} = 300 mA$   
 $L = 15 \mu H$ ,  $C_{OUT} = 68 \mu F$  (2x),  $C_{OUT}ESR = 25 m\Omega$

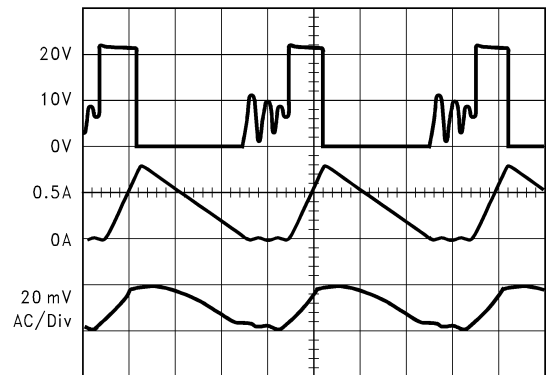

01293419

A:  $V_{SW}$  Pin Voltage, 10 V/div.  
 B: Inductor Current, 0.5 A/div  
 C: Output Ripple Voltage, 20 mV/div AC-Coupled

**Horizontal Time Base: 1  $\mu s$ /div**

## Load Transient Response for Continuous Mode

$V_{IN} = 20V$ ,  $V_{OUT} = 5V$ ,  $I_{LOAD} = 1A$   
 $L = 47 \mu H$ ,  $C_{OUT} = 68 \mu F$ ,  $C_{OUT}ESR = 50 m\Omega$

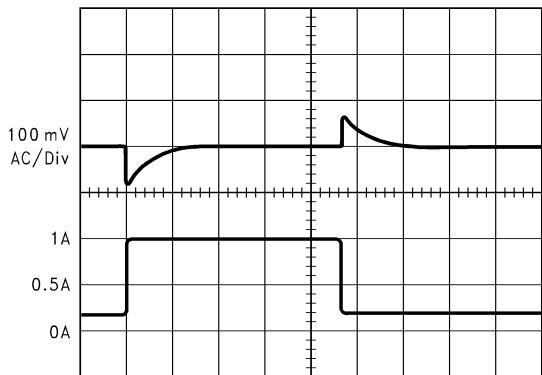

01293420

A: Output Voltage, 100 mV/div, AC-Coupled  
 B: Load Current: 200 mA to 1A Load Pulse

**Horizontal Time Base: 50  $\mu s$ /div**

## Load Transient Response for Discontinuous Mode

$V_{IN} = 20V$ ,  $V_{OUT} = 5V$ ,  
 $L = 47 \mu H$ ,  $C_{OUT} = 68 \mu F$ ,  $C_{OUT}ESR = 50 m\Omega$

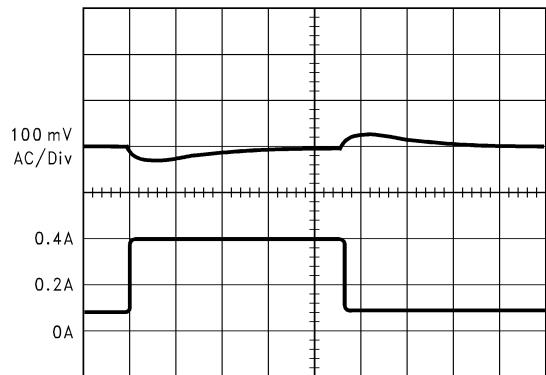

01293421

A: Output Voltage, 100 mV/div, AC-Coupled  
 B: Load Current: 100 mA to 300 mA Load Pulse

**Horizontal Time Base: 200  $\mu s$ /div**



## Test Circuit and Layout Guidelines

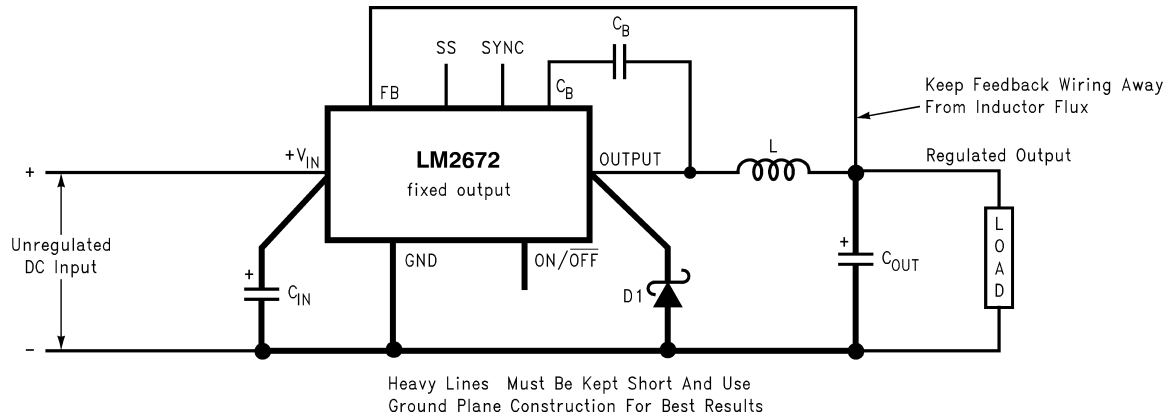

01293422

$C_{IN}$  - 22  $\mu$ F, 50V Tantalum, Sprague "199D Series"  
 $C_{OUT}$  - 47  $\mu$ F, 25V Tantalum, Sprague "595D Series"  
 D1 - 3.3A, 50V Schottky Rectifier, IR 30WQ05F  
 L1 - 68  $\mu$ H Sumida #RCR110D-680L  
 $C_B$  - 0.01  $\mu$ F, 50V Ceramic

**FIGURE 2. Standard Test Circuits and Layout Guides  
 Fixed Output Voltage Versions**

## Test Circuit and Layout Guidelines (Continued)

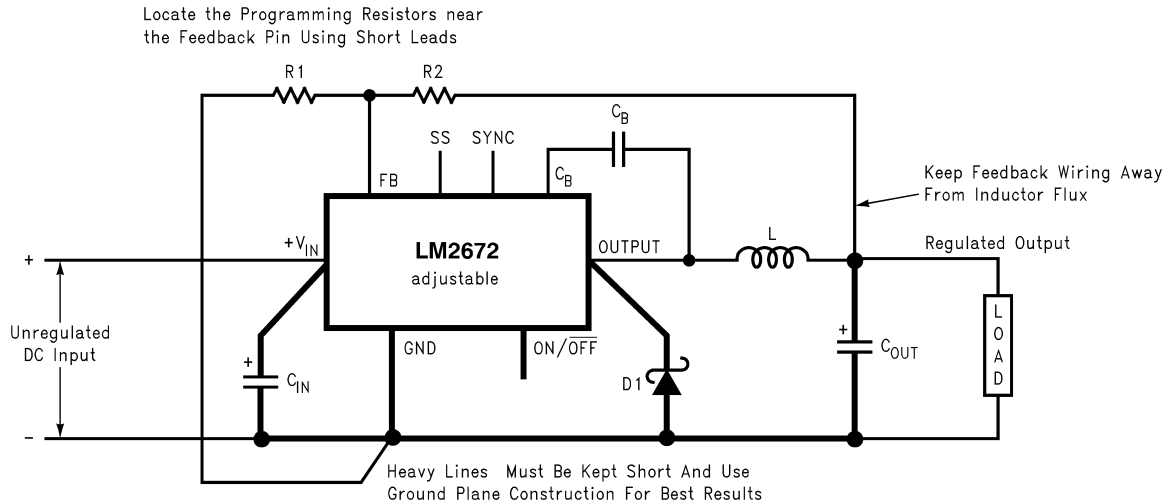

01293423

$C_{IN}$  - 22  $\mu$ F, 50V Tantalum, Sprague "199D Series"  
 $C_{OUT}$  - 47  $\mu$ F, 25V Tantalum, Sprague "595D Series"  
 D1 - 3.3A, 50V Schottky Rectifier, IR 30WQ05F  
 L1 - 68  $\mu$ H Sumida #RCR110D-680L  
 R1 - 1.5 k $\Omega$ , 1%  
 $C_B$  - 0.01  $\mu$ F, 50V Ceramic  
 For a 5V output, select R2 to be 4.75 k $\Omega$ , 1%

$$V_{OUT} = V_{REF} \left( 1 + \frac{R_2}{R_1} \right)$$

where  $V_{REF} = 1.21V$

$$R_2 = R_1 \left( \frac{V_{OUT}}{V_{REF}} - 1 \right)$$

Use a 1% resistor for best stability.

**FIGURE 3. Standard Test Circuits and Layout Guides  
Adjustable Output Voltage Versions**

## LM2672 Series Buck Regulator Design Procedure (Fixed Output)

### PROCEDURE (Fixed Output Voltage Version)

To simplify the buck regulator design procedure, National Semiconductor is making available computer design software to be used with the SIMPLE SWITCHER line of switching regulators. **LM267X Made Simple** version 1.0 is available on Windows® 3.1, NT, or 95 operating systems.

#### Given:

$V_{OUT}$  = Regulated Output Voltage (3.3V, 5V, or 12V)  
 $V_{IN(max)}$  = Maximum DC Input Voltage  
 $I_{LOAD(max)}$  = Maximum Load Current

### EXAMPLE (Fixed Output Voltage Version)

#### Given:

$V_{OUT} = 5V$   
 $V_{IN(max)} = 12V$   
 $I_{LOAD(max)} = 1A$

## LM2672 Series Buck Regulator Design Procedure (Fixed Output) (Continued)

PROCEDURE (Fixed Output Voltage Version)	EXAMPLE (Fixed Output Voltage Version)
<p><b>1. Inductor Selection (L1)</b></p> <p><b>A.</b> Select the correct inductor value selection guide from <i>Figure 4</i> and <i>Figure 5</i> or <i>Figure 6</i> (output voltages of 3.3V, 5V, or 12V respectively). For all other voltages, see the design procedure for the adjustable version.</p> <p><b>B.</b> From the inductor value selection guide, identify the inductance region intersected by the Maximum Input Voltage line and the Maximum Load Current line. Each region is identified by an inductance value and an inductor code (LXX).</p> <p><b>C.</b> Select an appropriate inductor from the four manufacturer's part numbers listed in <i>Figure 8</i>. Each manufacturer makes a different style of inductor to allow flexibility in meeting various design requirements. Listed below are some of the differentiating characteristics of each manufacturer's inductors:</p> <p><i>Schott</i>: ferrite EP core inductors; these have very low leakage magnetic fields to reduce electro-magnetic interference (EMI) and are the lowest power loss inductors</p> <p><i>Renco</i>: ferrite stick core inductors; benefits are typically lowest cost inductors and can withstand E•T and transient peak currents above rated value. Be aware that these inductors have an external magnetic field which may generate more EMI than other types of inductors.</p> <p><i>Pulse</i>: powdered iron toroid core inductors; these can also be low cost and can withstand larger than normal E•T and transient peak currents. Toroid inductors have low EMI.</p> <p><i>Coilcraft</i>: ferrite drum core inductors; these are the smallest physical size inductors, available only as SMT components. Be aware that these inductors also generate EMI—but less than stick inductors.</p> <p>Complete specifications for these inductors are available from the respective manufacturers. A table listing the manufacturers' phone numbers is located in <i>Figure 9</i>.</p> <p><b>2. Output Capacitor Selection (C<sub>OUT</sub>)</b></p> <p><b>A.</b> Select an output capacitor from the output capacitor table in <i>Figure 10</i>. Using the output voltage and the inductance value found in the inductor selection guide, step 1, locate the appropriate capacitor value and voltage rating.</p> <p>The capacitor list contains through-hole electrolytic capacitors from four different capacitor manufacturers and surface mount tantalum capacitors from two different capacitor manufacturers. It is recommended that both the manufacturers and the manufacturer's series that are listed in the table be used. A table listing the manufacturers' phone numbers is located in <i>Figure 11</i>.</p>	<p><b>1. Inductor Selection (L1)</b></p> <p><b>A.</b> Use the inductor selection guide for the 5V version shown in <i>Figure 5</i>.</p> <p><b>B.</b> From the inductor value selection guide shown in <i>Figure 5</i>, the inductance region intersected by the 12V horizontal line and the 1A vertical line is 33 <math>\mu</math>H, and the inductor code is L23.</p> <p><b>C.</b> The inductance value required is 33 <math>\mu</math>H. From the table in <i>Figure 8</i>, go to the L23 line and choose an inductor part number from any of the four manufacturers shown. (In most instances, both through hole and surface mount inductors are available.)</p> <p><b>2. Output Capacitor Selection (C<sub>OUT</sub>)</b></p> <p><b>A.</b> Use the 5.0V section in the output capacitor table in <i>Figure 10</i>. Choose a capacitor value and voltage rating from the line that contains the inductance value of 33 <math>\mu</math>H. The capacitance and voltage rating values corresponding to the 33 <math>\mu</math>H inductor are the:</p> <p>Surface Mount:</p> <p>68 <math>\mu</math>F/10V Sprague 594D Series. 100 <math>\mu</math>F/10V AVX TPS Series.</p> <p>Through Hole:</p> <p>68 <math>\mu</math>F/10V Sanyo OS-CON SA Series. 220 <math>\mu</math>F/35V Sanyo MV-GX Series. 220 <math>\mu</math>F/35V Nichicon PL Series. 220 <math>\mu</math>F/35V Panasonic HFQ Series.</p>

## LM2672 Series Buck Regulator Design Procedure (Fixed Output) (Continued)

PROCEDURE (Fixed Output Voltage Version)	EXAMPLE (Fixed Output Voltage Version)
<p><b>3. Catch Diode Selection (D1)</b></p> <p><b>A.</b> In normal operation, the average current of the catch diode is the load current times the catch diode duty cycle, 1-D (D is the switch duty cycle, which is approximately the output voltage divided by the input voltage). The largest value of the catch diode average current occurs at the maximum load current and maximum input voltage (minimum D). For normal operation, the catch diode current rating must be at least 1.3 times greater than its maximum average current. However, if the power supply design must withstand a continuous output short, the diode should have a current rating equal to the maximum current limit of the LM2672. The most stressful condition for this diode is a shorted output condition.</p> <p><b>B.</b> The reverse voltage rating of the diode should be at least 1.25 times the maximum input voltage.</p> <p><b>C.</b> Because of their fast switching speed and low forward voltage drop, Schottky diodes provide the best performance and efficiency. This Schottky diode must be located close to the LM2672 using short leads and short printed circuit traces.</p> <p><b>4. Input Capacitor (C<sub>IN</sub>)</b></p> <p>A low ESR aluminum or tantalum bypass capacitor is needed between the input pin and ground to prevent large voltage transients from appearing at the input. This capacitor should be located close to the IC using short leads. In addition, the RMS current rating of the input capacitor should be selected to be at least ½ the DC load current. The capacitor manufacturer data sheet must be checked to assure that this current rating is not exceeded. The curves shown in <i>Figure 14</i> show typical RMS current ratings for several different aluminum electrolytic capacitor values. A parallel connection of two or more capacitors may be required to increase the total minimum RMS current rating to suit the application requirements.</p> <p>For an aluminum electrolytic capacitor, the voltage rating should be at least 1.25 times the maximum input voltage. Caution must be exercised if solid tantalum capacitors are used. The tantalum capacitor voltage rating should be twice the maximum input voltage. The tables in <i>Figure 15</i> show the recommended application voltage for AVX TPS and Sprague 594D tantalum capacitors. It is also recommended that they be surge current tested by the manufacturer. The TPS series available from AVX, and the 593D and 594D series from Sprague are all surge current tested. Another approach to minimize the surge current stresses on the input capacitor is to add a small inductor in series with the input supply line.</p> <p>Use caution when using ceramic capacitors for input bypassing, because it may cause severe ringing at the V<sub>IN</sub> pin.</p> <p><b>5. Boost Capacitor (C<sub>B</sub>)</b></p> <p>This capacitor develops the necessary voltage to turn the switch gate on fully. All applications should use a 0.01 μF, 50V ceramic capacitor.</p> <p><b>6. Soft-Start Capacitor (C<sub>SS</sub> - optional)</b></p> <p>This capacitor controls the rate at which the device starts up. The formula for the soft-start capacitor C<sub>SS</sub> is:</p>	<p><b>3. Catch Diode Selection (D1)</b></p> <p><b>A.</b> Refer to the table shown in <i>Figure 12</i>. In this example, a 1A, 20V Schottky diode will provide the best performance. If the circuit must withstand a continuous shorted output, a higher current Schottky diode is recommended.</p> <p><b>4. Input Capacitor (C<sub>IN</sub>)</b></p> <p>The important parameters for the input capacitor are the input voltage rating and the RMS current rating. With a maximum input voltage of 12V, an aluminum electrolytic capacitor with a voltage rating greater than 15V (1.25 x V<sub>IN</sub>) would be needed. The next higher capacitor voltage rating is 16V.</p> <p>The RMS current rating requirement for the input capacitor in a buck regulator is approximately ½ the DC load current. In this example, with a 1A load, a capacitor with a RMS current rating of at least 500 mA is needed. The curves shown in <i>Figure 14</i> can be used to select an appropriate input capacitor. From the curves, locate the 16V line and note which capacitor values have RMS current ratings greater than 500 mA.</p> <p>For a through hole design, a 330 μF/16V electrolytic capacitor (Panasonic HFQ series, Nichicon PL, Sanyo MV-GX series or equivalent) would be adequate. Other types or other manufacturers' capacitors can be used provided the RMS ripple current ratings are adequate. Additionally, for a complete surface mount design, electrolytic capacitors such as the Sanyo CV-C or CV-BS and the Nichicon WF or UR and the NIC Components NACZ series could be considered.</p> <p>For surface mount designs, solid tantalum capacitors can be used, but caution must be exercised with regard to the capacitor surge current rating and voltage rating. In this example, checking <i>Figure 15</i>, and the Sprague 594D series datasheet, a Sprague 594D 15 μF, 25V capacitor is adequate.</p> <p><b>5. Boost Capacitor (C<sub>B</sub>)</b></p> <p>For this application, and all applications, use a 0.01 μF, 50V ceramic capacitor.</p> <p><b>6. Soft-Start Capacitor (C<sub>SS</sub> - optional)</b></p> <p>For this application, selecting a start-up time of 10 ms and using the formula for C<sub>SS</sub> results in a value of:</p>

# LM2672 Series Buck Regulator Design Procedure (Fixed Output) (Continued)

## PROCEDURE (Fixed Output Voltage Version)

$$C_{SS} \approx (I_{SS} \cdot t_{SS}) / [V_{SSTH} + 2.6V \cdot (\frac{V_{OUT} + V_{SCHOTTKY}}{V_{IN}})]$$

where:

- $I_{SS}$  = Soft-Start Current :4.5  $\mu$ A typical.
- $t_{SS}$  = Soft-Start Time :Selected.
- $V_{SSTH}$  = Soft-Start Threshold Voltage :0.63V typical.
- $V_{OUT}$  = Output Voltage :Selected.
- $V_{SCHOTTKY}$  = Schottky Diode Voltage Drop :0.4V typical.
- $V_{IN}$  = Input Voltage :Selected.

If this feature is not desired, leave this pin open.

### 7. Frequency Synchronization (optional)

The LM2672 (oscillator) can be synchronized to run with an external oscillator, using the sync pin (pin 3). By doing so, the LM2672 can be operated at higher frequencies than the standard frequency of 260 kHz. This allows for a reduction in the size of the inductor and output capacitor. As shown in the drawing below, a signal applied to a RC filter at the sync pin causes the device to synchronize to the frequency of that signal. For a signal with a peak-to-peak amplitude of 3V or greater, a 1 k $\Omega$  resistor and a 100 pF capacitor are suitable values.

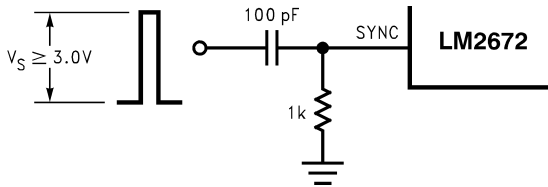

### INDUCTOR VALUE SELECTION GUIDES (For Continuous Mode Operation)

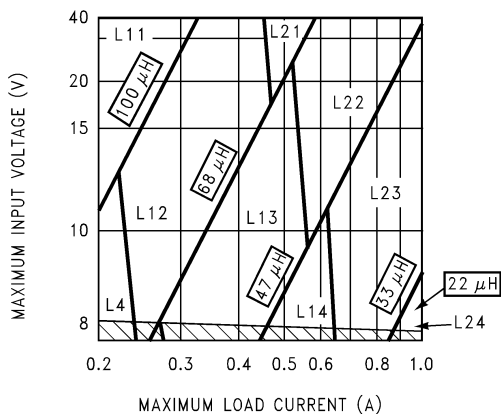

FIGURE 4. LM2672-3.3

01293429

## EXAMPLE (Fixed Output Voltage Version)

$$C_{SS} \approx (4.5 \mu A \cdot 10 \text{ ms}) / [0.63V + 2.6V \cdot (\frac{5V + 0.4V}{12V})]$$

$$= 25 \text{ nF} \approx 0.022 \mu F.$$

### 7. Frequency Synchronization (optional)

For all applications, use a 1 k $\Omega$  resistor and a 100 pF capacitor for the RC filter.

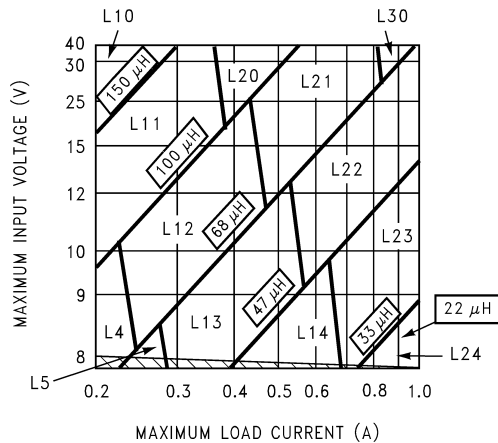

FIGURE 5. LM2672-5.0

01293430

# LM2672 Series Buck Regulator Design Procedure (Fixed Output)

(Continued)

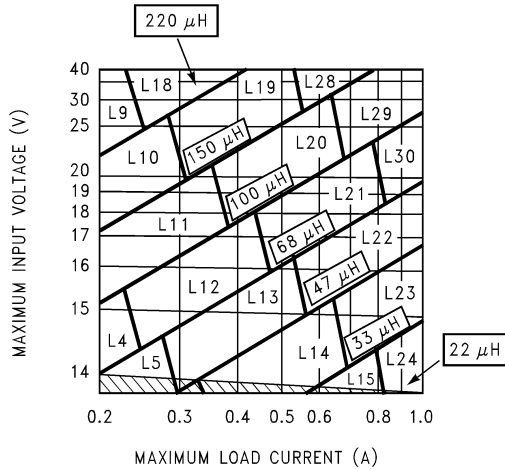

FIGURE 6. LM2672-12

01293431

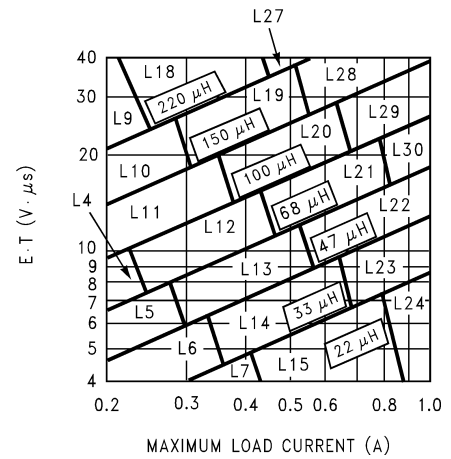

FIGURE 7. LM2672-ADJ

01293432

Ind. Ref. Desg.	Inductance (μH)	Current (A)	Schott		Renco		Pulse Engineering		Coilcraft
			Through Hole	Surface Mount	Through Hole	Surface Mount	Through Hole	Surface Mount	Surface Mount
L4	68	0.32	67143940	67144310	RL-1284-68-43	RL1500-68	PE-53804	PE-53804-S	DO1608-683
L5	47	0.37	67148310	67148420	RL-1284-47-43	RL1500-47	PE-53805	PE-53805-S	DO1608-473
L6	33	0.44	67148320	67148430	RL-1284-33-43	RL1500-33	PE-53806	PE-53806-S	DO1608-333
L7	22	0.52	67148330	67148440	RL-1284-22-43	RL1500-22	PE-53807	PE-53807-S	DO1608-223
L9	220	0.32	67143960	67144330	RL-5470-3	RL1500-220	PE-53809	PE-53809-S	DO3308-224
L10	150	0.39	67143970	67144340	RL-5470-4	RL1500-150	PE-53810	PE-53810-S	DO3308-154
L11	100	0.48	67143980	67144350	RL-5470-5	RL1500-100	PE-53811	PE-53811-S	DO3308-104
L12	68	0.58	67143990	67144360	RL-5470-6	RL1500-68	PE-53812	PE-53812-S	DO3308-683
L13	47	0.70	67144000	67144380	RL-5470-7	RL1500-47	PE-53813	PE-53813-S	DO3308-473
L14	33	0.83	67148340	67148450	RL-1284-33-43	RL1500-33	PE-53814	PE-53814-S	DO3308-333
L15	22	0.99	67148350	67148460	RL-1284-22-43	RL1500-22	PE-53815	PE-53815-S	DO3308-223
L18	220	0.55	67144040	67144420	RL-5471-2	RL1500-220	PE-53818	PE-53818-S	DO3316-224
L19	150	0.66	67144050	67144430	RL-5471-3	RL1500-150	PE-53819	PE-53819-S	DO3316-154
L20	100	0.82	67144060	67144440	RL-5471-4	RL1500-100	PE-53820	PE-53820-S	DO3316-104
L21	68	0.99	67144070	67144450	RL-5471-5	RL1500-68	PE-53821	PE-53821-S	DO3316-683
L22	47	1.17	67144080	67144460	RL-5471-6	—	PE-53822	PE-53822-S	DO3316-473
L23	33	1.40	67144090	67144470	RL-5471-7	—	PE-53823	PE-53823-S	DO3316-333
L24	22	1.70	67148370	67148480	RL-1283-22-43	—	PE-53824	PE-53824-S	DO3316-223
L27	220	1.00	67144110	67144490	RL-5471-2	—	PE-53827	PE-53827-S	DO5022P-224
L28	150	1.20	67144120	67144500	RL-5471-3	—	PE-53828	PE-53828-S	DO5022P-154
L29	100	1.47	67144130	67144510	RL-5471-4	—	PE-53829	PE-53829-S	DO5022P-104
L30	68	1.78	67144140	67144520	RL-5471-5	—	PE-53830	PE-53830-S	DO5022P-683

FIGURE 8. Inductor Manufacturers' Part Numbers

## LM2672 Series Buck Regulator Design Procedure (Fixed Output) (Continued)

<b>Coilcraft Inc.</b>	Phone	(800) 322-2645
	FAX	(708) 639-1469
<b>Coilcraft Inc., Europe</b>	Phone	+44 1236 730 595
	FAX	+44 1236 730 627
<b>Pulse Engineering Inc.</b>	Phone	(619) 674-8100
	FAX	(619) 674-8262
<b>Pulse Engineering Inc., Europe</b>	Phone	+353 93 24 107
	FAX	+353 93 24 459
<b>Renco Electronics Inc.</b>	Phone	(800) 645-5828
	FAX	(516) 586-5562
<b>Schott Corp.</b>	Phone	(612) 475-1173
	FAX	(612) 475-1786

FIGURE 9. Inductor Manufacturers' Phone Numbers

Output Voltage (V)	Inductance ( $\mu$ H)	Output Capacitor					
		Surface Mount		Through Hole			
		Sprague 594D Series ( $\mu$ F/V)	AVX TPS Series ( $\mu$ F/V)	Sanyo OS-CON SA Series ( $\mu$ F/V)	Sanyo MV-GX Series ( $\mu$ F/V)	Nichicon PL Series ( $\mu$ F/V)	Panasonic HFQ Series ( $\mu$ F/V)
3.3	22	120/6.3	100/10	100/10	330/35	330/35	330/35
	33	120/6.3	100/10	68/10	220/35	220/35	220/35
	47	68/10	100/10	68/10	150/35	150/35	150/35
	68	120/6.3	100/10	100/10	120/35	120/35	120/35
	100	120/6.3	100/10	100/10	120/35	120/35	120/35
	150	120/6.3	100/10	100/10	120/35	120/35	120/35
5.0	22	100/16	100/10	100/10	330/35	330/35	330/35
	33	68/10	100/10	68/10	220/35	220/35	220/35
	47	68/10	100/10	68/10	150/35	150/35	150/35
	68	100/16	100/10	100/10	120/35	120/35	120/35
	100	100/16	100/10	100/10	120/35	120/35	120/35
	150	100/16	100/10	100/10	120/35	120/35	120/35
12	22	120/20	(2x) 68/20	68/20	330/35	330/35	330/35
	33	68/25	68/20	68/20	220/35	220/35	220/35
	47	47/20	68/20	47/20	150/35	150/35	150/35
	68	47/20	68/20	47/20	120/35	120/35	120/35
	100	47/20	68/20	47/20	120/35	120/35	120/35
	150	47/20	68/20	47/20	120/35	120/35	120/35
	220	47/20	68/20	47/20	120/35	120/35	120/35

FIGURE 10. Output Capacitor Table

## LM2672 Series Buck Regulator Design Procedure (Fixed Output) (Continued)

<b>Nichicon Corp.</b>	Phone	(847) 843-7500
	FAX	(847) 843-2798
<b>Panasonic</b>	Phone	(714) 373-7857
	FAX	(714) 373-7102
<b>AVX Corp.</b>	Phone	(803) 448-9411
	FAX	(803) 448-1943
<b>Sprague/Vishay</b>	Phone	(207) 324-4140
	FAX	(207) 324-7223
<b>Sanyo Corp.</b>	Phone	(619) 661-6322
	FAX	(619) 661-1055

FIGURE 11. Capacitor Manufacturers' Phone Numbers

$V_R$	1A Diodes		3A Diodes	
	Surface Mount	Through Hole	Surface Mount	Through Hole
20V	SK12	1N5817	SK32	1N5820
	B120	SR102		SR302
30V	SK13	1N5818	SK33	1N5821
	B130	11DQ03	30WQ03F	31DQ03
	MBRS130	SR103		
40V	SK14	1N5819	SK34	1N5822
	B140	11DQ04	30BQ040	MBR340
	MBRS140	SR104	30WQ04F	31DQ04
	10BQ040		MBRS340	SR304
	10MQ040		MBRD340	
50V	SK15	MBR150	SK35	MBR350
	B150	11DQ05	30WQ05F	31DQ05
	10BQ050	SR105		SR305

FIGURE 12. Schottky Diode Selection Table

<b>International Rectifier Corp.</b>	Phone	(310) 322-3331
	FAX	(310) 322-3332
<b>Motorola, Inc.</b>	Phone	(800) 521-6274
	FAX	(602) 244-6609
<b>General Instruments Corp.</b>	Phone	(516) 847-3000
	FAX	(516) 847-3236
<b>Diodes, Inc.</b>	Phone	(805) 446-4800
	FAX	(805) 446-4850

FIGURE 13. Diode Manufacturers' Phone Numbers



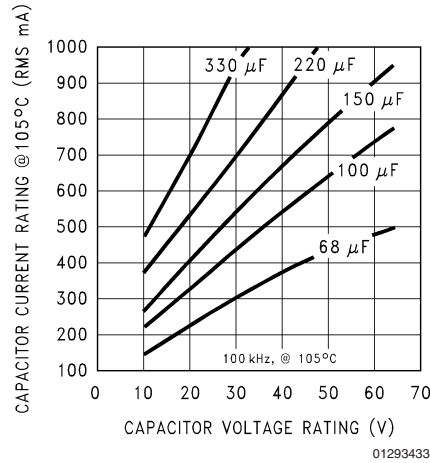

FIGURE 14. RMS Current Ratings for Low ESR Electrolytic Capacitors (Typical)

AVX TPS

Recommended Application Voltage	Voltage Rating
<b>+85°C Rating</b>	
3.3	6.3
5	10
10	20
12	25
15	35

Sprague 594D

Recommended Application Voltage	Voltage Rating
<b>+85°C Rating</b>	
2.5	4
3.3	6.3
5	10
8	16
12	20
18	25
24	35
29	50

FIGURE 15. Recommended Application Voltage for AVX TPS and Sprague 594D Tantalum Chip Capacitors Derated for 85°C.

## LM2672 Series Buck Regulator Design Procedure (Adjustable Output)

PROCEDURE (Adjustable Output Voltage Version)	EXAMPLE (Adjustable Output Voltage Version)
<p>To simplify the buck regulator design procedure, National Semiconductor is making available computer design software to be used with the SIMPLE SWITCHER line of switching regulators. <b>LM267X Made Simple</b> version 1.0 is available on Windows 3.1, NT, or 95 operating systems.</p> <p><b>Given:</b></p> <p><math>V_{OUT}</math> = Regulated Output Voltage  <math>V_{IN(max)}</math> = Maximum Input Voltage  <math>I_{LOAD(max)}</math> = Maximum Load Current  <math>F</math> = Switching Frequency (Fixed at a nominal 260 kHz).</p> <p><b>1. Programming Output Voltage</b> (Selecting <math>R_1</math> and <math>R_2</math>, as shown in Figure 3)            Use the following formula to select the appropriate resistor values.</p> $V_{OUT} = V_{REF} \left( 1 + \frac{R_2}{R_1} \right)$ <p>where <math>V_{REF} = 1.21V</math></p> <p>Select a value for <math>R_1</math> between 240<math>\Omega</math> and 1.5 k<math>\Omega</math>. The lower resistor values minimize noise pickup in the sensitive feedback pin. (For the lowest temperature coefficient and the best stability with time, use 1% metal film resistors.)</p> $R_2 = R_1 \left( \frac{V_{OUT}}{V_{REF}} - 1 \right)$ <p><b>2. Inductor Selection (L1)</b></p> <p><b>A.</b> Calculate the inductor Volt • microsecond constant <math>E \cdot T</math> (<math>V \cdot \mu s</math>), from the following formula:</p> $E \cdot T = (V_{IN(MAX)} - V_{OUT} - V_{SAT}) \cdot \frac{V_{OUT} + V_D}{V_{IN(MAX)} - V_{SAT} + V_D} \cdot \frac{1000}{260} (V \cdot \mu s)$ <p>where <math>V_{SAT}</math>=internal switch saturation voltage=0.25V and <math>V_D</math> = diode forward voltage drop = 0.5V</p> <p><b>B.</b> Use the <math>E \cdot T</math> value from the previous formula and match it with the <math>E \cdot T</math> number on the vertical axis of the Inductor Value Selection Guide shown in Figure 7.</p> <p><b>C.</b> On the horizontal axis, select the maximum load current.</p> <p><b>D.</b> Identify the inductance region intersected by the <math>E \cdot T</math> value and the Maximum Load Current value. Each region is identified by an inductance value and an inductor code (LXX).</p> <p><b>E.</b> Select an appropriate inductor from the four manufacturer's part numbers listed in Figure 8. For information on the different types of inductors, see the inductor selection in the fixed output voltage design procedure.</p> <p><b>3. Output Capacitor Selection (<math>C_{OUT}</math>)</b></p> <p><b>A.</b> Select an output capacitor from the capacitor code selection guide in Figure 16. Using the inductance value found in the inductor selection guide, step 1, locate the appropriate capacitor code corresponding to the desired output voltage.</p>	<p><b>Given:</b></p> <p><math>V_{OUT} = 20V</math>  <math>V_{IN(max)} = 28V</math>  <math>I_{LOAD(max)} = 1A</math>  <math>F</math> = Switching Frequency (Fixed at a nominal 260 kHz).</p> <p><b>1. Programming Output Voltage</b> (Selecting <math>R_1</math> and <math>R_2</math>, as shown in Figure 3)            Select <math>R_1</math> to be 1 k<math>\Omega</math>, 1%. Solve for <math>R_2</math>.</p> $R_2 = R_1 \left( \frac{V_{OUT}}{V_{REF}} - 1 \right) = 1 k\Omega \left( \frac{20V}{1.23V} - 1 \right)$ <p><math>R_2 = 1 k\Omega (16.53 - 1) = 15.53 k\Omega</math>, closest 1% value is 15.4 k<math>\Omega</math>.  <math>R_2 = 15.4 k\Omega</math>.</p> <p><b>2. Inductor Selection (L1)</b></p> <p><b>A.</b> Calculate the inductor Volt • microsecond constant (<math>E \cdot T</math>),</p> $E \cdot T = (28 - 20 - 0.25) \cdot \frac{20 + 0.5}{28 - 0.25 + 0.5} \cdot \frac{1000}{260} (V \cdot \mu s)$ $E \cdot T = (7.75) \cdot \frac{20.5}{28.25} \cdot 3.85 (V \cdot \mu s) = 21.6 (V \cdot \mu s)$ <p><b>B.</b> <math>E \cdot T = 21.6 (V \cdot \mu s)</math></p> <p><b>C.</b> <math>I_{LOAD(max)} = 1A</math></p> <p><b>D.</b> From the inductor value selection guide shown in Figure 7, the inductance region intersected by the 21.6 (<math>V \cdot \mu s</math>) horizontal line and the 1A vertical line is 68 <math>\mu H</math>, and the inductor code is L30.</p> <p><b>E.</b> From the table in Figure 8, locate line L30, and select an inductor part number from the list of manufacturers' part numbers.</p> <p><b>3. Output Capacitor Selection (<math>C_{OUT}</math>)</b></p> <p><b>A.</b> Use the appropriate row of the capacitor code selection guide, in Figure 16. For this example, use the 15–20V row. The capacitor code corresponding to an inductance of 68 <math>\mu H</math> is C20.</p>

## LM2672 Series Buck Regulator Design Procedure (Adjustable Output)

(Continued)

PROCEDURE (Adjustable Output Voltage Version)	EXAMPLE (Adjustable Output Voltage Version)
<p><b>B.</b> Select an appropriate capacitor value and voltage rating, using the capacitor code, from the output capacitor selection table in <i>Figure 17</i>. There are two solid tantalum (surface mount) capacitor manufacturers and four electrolytic (through hole) capacitor manufacturers to choose from. It is recommended that both the manufacturers and the manufacturer's series that are listed in the table be used. A table listing the manufacturers' phone numbers is located in <i>Figure 11</i>.</p> <p><b>4. Catch Diode Selection (D1)</b></p> <p><b>A.</b> In normal operation, the average current of the catch diode is the load current times the catch diode duty cycle, 1-D (D is the switch duty cycle, which is approximately <math>V_{OUT}/V_{IN}</math>). The largest value of the catch diode average current occurs at the maximum input voltage (minimum D). For normal operation, the catch diode current rating must be at least 1.3 times greater than its maximum average current. However, if the power supply design must withstand a continuous output short, the diode should have a current rating greater than the maximum current limit of the LM2672. The most stressful condition for this diode is a shorted output condition.</p> <p><b>B.</b> The reverse voltage rating of the diode should be at least 1.25 times the maximum input voltage.</p> <p><b>C.</b> Because of their fast switching speed and low forward voltage drop, Schottky diodes provide the best performance and efficiency. The Schottky diode must be located close to the LM2672 using short leads and short printed circuit traces.</p>	<p><b>B.</b> From the output capacitor selection table in <i>Figure 17</i>, choose a capacitor value (and voltage rating) that intersects the capacitor code(s) selected in section A, C20. The capacitance and voltage rating values corresponding to the capacitor code C20 are the:</p> <p>Surface Mount:  33 <math>\mu</math>F/25V Sprague 594D Series.  33 <math>\mu</math>F/25V AVX TPS Series.</p> <p>Through Hole:  33 <math>\mu</math>F/25V Sanyo OS-CON SC Series.  120 <math>\mu</math>F/35V Sanyo MV-GX Series.  120 <math>\mu</math>F/35V Nichicon PL Series.  120 <math>\mu</math>F/35V Panasonic HFQ Series.</p> <p>Other manufacturers or other types of capacitors may also be used, provided the capacitor specifications (especially the 100 kHz ESR) closely match the characteristics of the capacitors listed in the output capacitor table. Refer to the capacitor manufacturers' data sheet for this information.</p> <p><b>4. Catch Diode Selection (D1)</b></p> <p><b>A.</b> Refer to the table shown in <i>Figure 12</i>. Schottky diodes provide the best performance, and in this example a 1A, 40V Schottky diode would be a good choice. If the circuit must withstand a continuous shorted output, a higher current (at least 2.2A) Schottky diode is recommended.</p>

## LM2672 Series Buck Regulator Design Procedure (Adjustable Output)

(Continued)

PROCEDURE (Adjustable Output Voltage Version)	EXAMPLE (Adjustable Output Voltage Version)
<p><b>5. Input Capacitor (<math>C_{IN}</math>)</b></p> <p>A low ESR aluminum or tantalum bypass capacitor is needed between the input pin and ground to prevent large voltage transients from appearing at the input. This capacitor should be located close to the IC using short leads. In addition, the RMS current rating of the input capacitor should be selected to be at least <math>\frac{1}{2}</math> the DC load current. The capacitor manufacturer data sheet must be checked to assure that this current rating is not exceeded. The curves shown in <i>Figure 14</i> show typical RMS current ratings for several different aluminum electrolytic capacitor values. A parallel connection of two or more capacitors may be required to increase the total minimum RMS current rating to suit the application requirements.</p> <p>For an aluminum electrolytic capacitor, the voltage rating should be at least 1.25 times the maximum input voltage. Caution must be exercised if solid tantalum capacitors are used. The tantalum capacitor voltage rating should be twice the maximum input voltage. The tables in <i>Figure 15</i> show the recommended application voltage for AVX TPS and Sprague 594D tantalum capacitors. It is also recommended that they be surge current tested by the manufacturer. The TPS series available from AVX, and the 593D and 594D series from Sprague are all surge current tested. Another approach to minimize the surge current stresses on the input capacitor is to add a small inductor in series with the input supply line.</p> <p>Use caution when using ceramic capacitors for input bypassing, because it may cause severe ringing at the <math>V_{IN}</math> pin.</p> <p><b>6. Boost Capacitor (<math>C_B</math>)</b></p> <p>This capacitor develops the necessary voltage to turn the switch gate on fully. All applications should use a 0.01 <math>\mu</math>F, 50V ceramic capacitor.</p> <p>If the soft-start and frequency synchronization features are desired, look at steps 6 and 7 in the fixed output design procedure.</p>	<p><b>5. Input Capacitor (<math>C_{IN}</math>)</b></p> <p>The important parameters for the input capacitor are the input voltage rating and the RMS current rating. With a maximum input voltage of 28V, an aluminum electrolytic capacitor with a voltage rating of at least 35V (<math>1.25 \times V_{IN}</math>) would be needed. The RMS current rating requirement for the input capacitor in a buck regulator is approximately <math>\frac{1}{2}</math> the DC load current. In this example, with a 1A load, a capacitor with a RMS current rating of at least 500 mA is needed. The curves shown in <i>Figure 14</i> can be used to select an appropriate input capacitor. From the curves, locate the 35V line and note which capacitor values have RMS current ratings greater than 500 mA.</p> <p>For a through hole design, a 330 <math>\mu</math>F/35V electrolytic capacitor (Panasonic HFQ series, Nichicon PL, Sanyo MV-GX series or equivalent) would be adequate. Other types or other manufacturers' capacitors can be used provided the RMS ripple current ratings are adequate. Additionally, for a complete surface mount design, electrolytic capacitors such as the Sanyo CV-C or CV-BS and the Nichicon WF or UR and the NIC Components NACZ series could be considered.</p> <p>For surface mount designs, solid tantalum capacitors can be used, but caution must be exercised with regard to the capacitor surge current rating and voltage rating. In this example, checking <i>Figure 15</i>, and the Sprague 594D series datasheet, a Sprague 594D 15 <math>\mu</math>F, 50V capacitor is adequate.</p> <p><b>6. Boost Capacitor (<math>C_B</math>)</b></p> <p>For this application, and all applications, use a 0.01 <math>\mu</math>F, 50V ceramic capacitor.</p>

Case Style (Note 7)	Output Voltage (V)	Inductance ( $\mu$ H)						
		22	33	47	68	100	150	220
SM and TH	1.21–2.50	—	—	—	—	C1	C2	C3
SM and TH	2.50–3.75	—	—	—	C1	C2	C3	C3
SM and TH	3.75–5.0	—	—	C4	C5	C6	C6	C6
SM and TH	5.0–6.25	—	C4	C7	C6	C6	C6	C6
SM and TH	6.25–7.5	C8	C4	C7	C6	C6	C6	C6
SM and TH	7.5–10.0	C9	C10	C11	C12	C13	C13	C13
SM and TH	10.0–12.5	C14	C11	C12	C12	C13	C13	C13
SM and TH	12.5–15.0	C15	C16	C17	C17	C17	C17	C17
SM and TH	15.0–20.0	C18	C19	C20	C20	C20	C20	C20
SM and TH	20.0–30.0	C21	C22	C22	C22	C22	C22	C22
TH	30.0–37.0	C23	C24	C24	C25	C25	C25	C25

Note 7: SM - Surface Mount, TH - Through Hole

FIGURE 16. Capacitor Code Selection Guide

## LM2672 Series Buck Regulator Design Procedure (Adjustable Output)

(Continued)

Cap. Ref. Desg. #	Output Capacitor					
	Surface Mount		Through Hole			
	Sprague 594D Series ( $\mu\text{F/V}$ )	AVX TPS Series ( $\mu\text{F/V}$ )	Sanyo OS-CON SA Series ( $\mu\text{F/V}$ )	Sanyo MV-GX Series ( $\mu\text{F/V}$ )	Nichicon PL Series ( $\mu\text{F/V}$ )	Panasonic HFQ Series ( $\mu\text{F/V}$ )
C1	120/6.3	100/10	100/10	220/35	220/35	220/35
C2	120/6.3	100/10	100/10	150/35	150/35	150/35
C3	120/6.3	100/10	100/35	120/35	120/35	120/35
C4	68/10	100/10	68/10	220/35	220/35	220/35
C5	100/16	100/10	100/10	150/35	150/35	150/35
C6	100/16	100/10	100/10	120/35	120/35	120/35
C7	68/10	100/10	68/10	150/35	150/35	150/35
C8	100/16	100/10	100/10	330/35	330/35	330/35
C9	100/16	100/16	100/16	330/35	330/35	330/35
C10	100/16	100/16	68/16	220/35	220/35	220/35
C11	100/16	100/16	68/16	150/35	150/35	150/35
C12	100/16	100/16	68/16	120/35	120/35	120/35
C13	100/16	100/16	100/16	120/35	120/35	120/35
C14	100/16	100/16	100/16	220/35	220/35	220/35
C15	47/20	68/20	47/20	220/35	220/35	220/35
C16	47/20	68/20	47/20	150/35	150/35	150/35
C17	47/20	68/20	47/20	120/35	120/35	120/35
C18	68/25	(2x) 33/25	47/25 (Note 8)	220/35	220/35	220/35
C19	33/25	33/25	33/25 (Note 8)	150/35	150/35	150/35
C20	33/25	33/25	33/25 (Note 8)	120/35	120/35	120/35
C21	33/35	(2x) 22/25	(Note 9)	150/35	150/35	150/35
C22	33/35	22/35	(Note 9)	120/35	120/35	120/35
C23	(Note 9)	(Note 9)	(Note 9)	220/50	100/50	120/50
C24	(Note 9)	(Note 9)	(Note 9)	150/50	100/50	120/50
C25	(Note 9)	(Note 9)	(Note 9)	150/50	82/50	82/50

**Note 8:** The SC series of Os-Con capacitors (others are SA series)

**Note 9:** The voltage ratings of the surface mount tantalum chip and Os-Con capacitors are too low to work at these voltages.

**FIGURE 17. Output Capacitor Selection Table**

## Application Information

### TYPICAL SURFACE MOUNT PC BOARD LAYOUT, FIXED OUTPUT (4X SIZE)

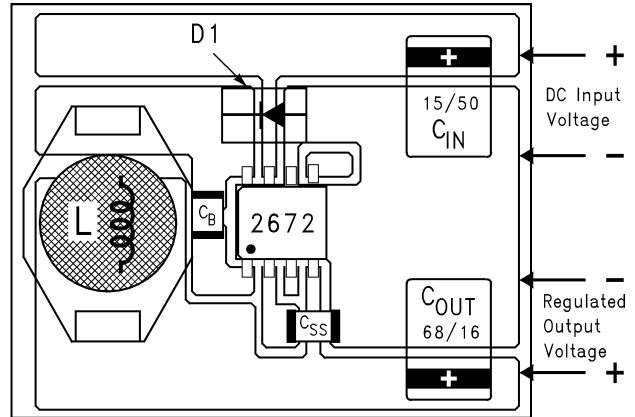
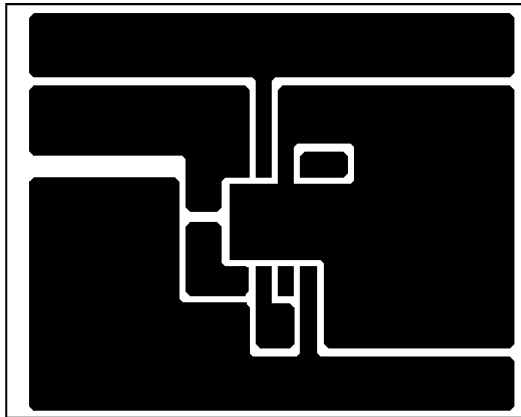

01293439

- $C_{IN}$  - 15  $\mu$ F, 50V, Solid Tantalum Sprague, "594D series"  
 $C_{OUT}$  - 68  $\mu$ F, 16V, Solid Tantalum Sprague, "594D series"  
 D1 - 1A, 40V Schottky Rectifier, Surface Mount  
 L1 - 33  $\mu$ H, L23, Coilcraft DO3316  
 $C_B$  - 0.01  $\mu$ F, 50V, Ceramic

### TYPICAL SURFACE MOUNT PC BOARD LAYOUT, ADJUSTABLE OUTPUT (4X SIZE)

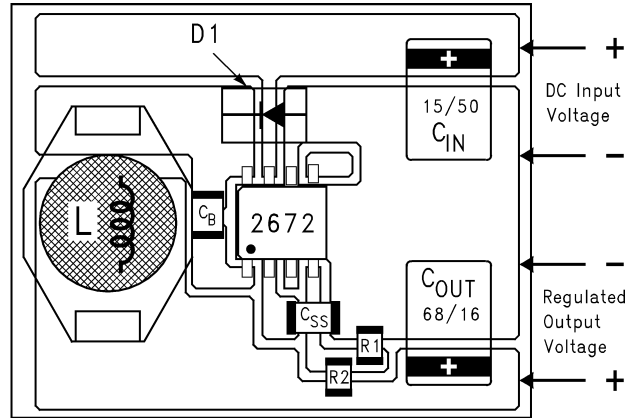
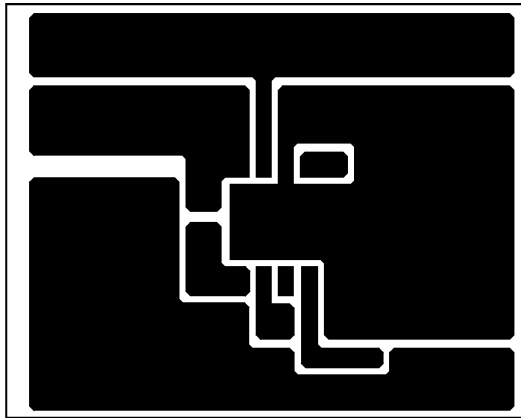

01293440

- $C_{IN}$  - 15  $\mu$ F, 50V, Solid Tantalum Sprague, "594D series"  
 $C_{OUT}$  - 33  $\mu$ F, 25V, Solid Tantalum Sprague, "594D series"  
 D1 - 1A, 40V Schottky Rectifier, Surface Mount  
 L1 - 68  $\mu$ H, L30, Coilcraft DO3316  
 $C_B$  - 0.01  $\mu$ F, 50V, Ceramic  
 R1 - 1k, 1%  
 R2 - Use formula in Design Procedure

FIGURE 18. PC Board Layout

Layout is very important in switching regulator designs. Rapidly switching currents associated with wiring inductance can generate voltage transients which can cause problems. For minimal inductance and ground loops, the wires indicated by **heavy lines** (in *Figure 2* and *Figure 3*) should be wide printed circuit traces and should be kept as short as

**possible.** For best results, external components should be located as close to the switcher IC as possible using ground plane construction or single point grounding.

If **open core inductors** are used, special care must be taken as to the location and positioning of this type of inductor. Allowing the inductor flux to intersect sensitive feedback, IC ground path, and  $C_{OUT}$  wiring can cause problems.

**Application Information** (Continued)

When using the adjustable version, special care must be taken as to the location of the feedback resistors and the

associated wiring. Physically locate both resistors near the IC, and route the wiring away from the inductor, especially an open core type of inductor.

# Physical Dimensions inches (millimeters)

unless otherwise noted

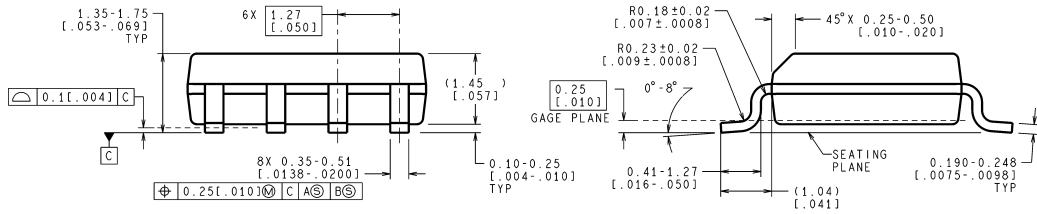
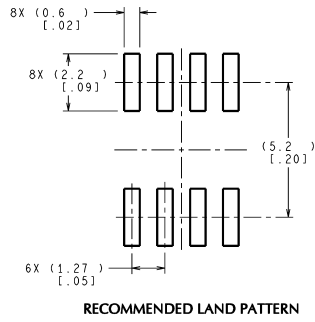
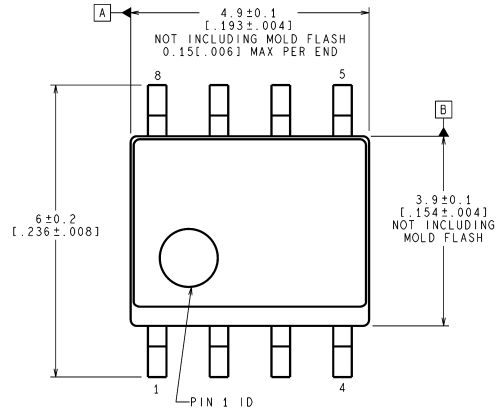

CONTROLLING DIMENSION IS MILLIMETER  
 VALUES IN [ ] ARE INCHES  
 DIMENSIONS IN ( ) FOR REFERENCE ONLY

M08A (Rev K)

**8-Lead (0.150" Wide) Molded Small Outline Package, JEDEC**  
**Order Number LM2672M-3.3, LM2672M-5.0,**  
**LM2672M-12 or LM2672M-ADJ**  
**NS Package Number M08A**



**Physical Dimensions** inches (millimeters) unless otherwise noted (Continued)

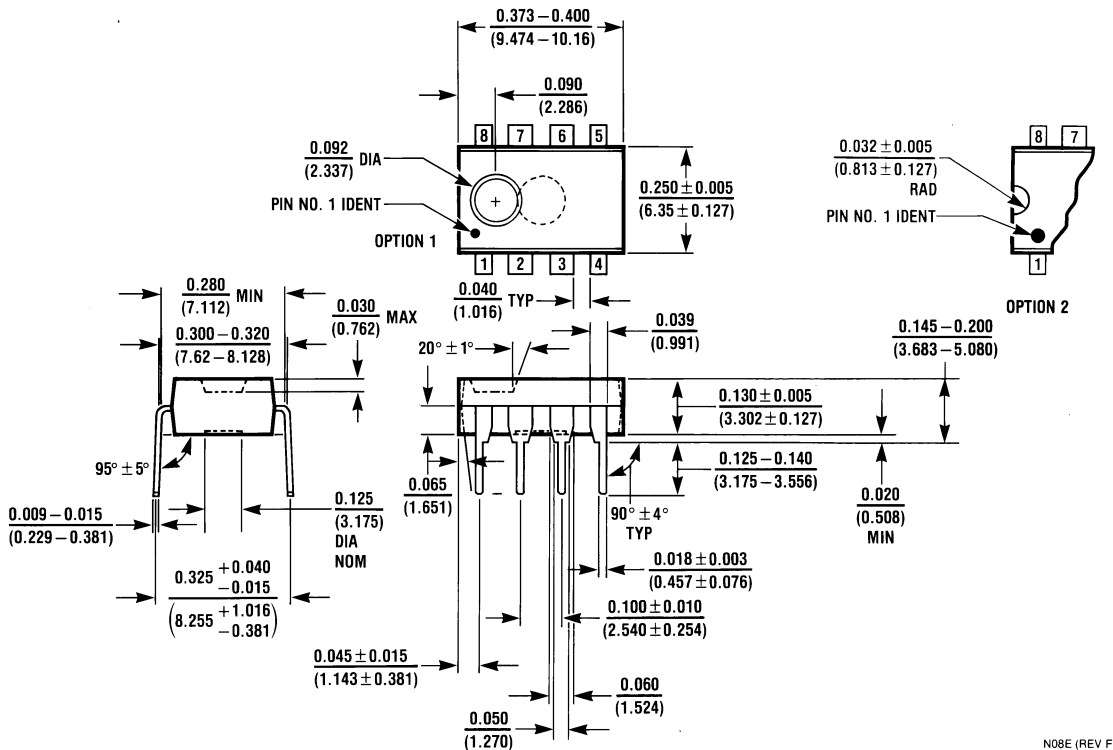

**8-Lead (0.300" Wide) Molded Dual-In-Line Package**  
**Order Number LM2672N-3.3, LM2672N-5.0,**  
**LM2672N-12 or LM2672N-ADJ**  
**NS Package Number N08E**

National does not assume any responsibility for use of any circuitry described, no circuit patent licenses are implied and National reserves the right at any time without notice to change said circuitry and specifications.

For the most current product information visit us at [www.national.com](http://www.national.com).

**LIFE SUPPORT POLICY**

NATIONAL'S PRODUCTS ARE NOT AUTHORIZED FOR USE AS CRITICAL COMPONENTS IN LIFE SUPPORT DEVICES OR SYSTEMS WITHOUT THE EXPRESS WRITTEN APPROVAL OF THE PRESIDENT AND GENERAL COUNSEL OF NATIONAL SEMICONDUCTOR CORPORATION. As used herein:

1. Life support devices or systems are devices or systems which, (a) are intended for surgical implant into the body, or (b) support or sustain life, and whose failure to perform when properly used in accordance with instructions for use provided in the labeling, can be reasonably expected to result in a significant injury to the user.
2. A critical component is any component of a life support device or system whose failure to perform can be reasonably expected to cause the failure of the life support device or system, or to affect its safety or effectiveness.

**BANNED SUBSTANCE COMPLIANCE**

National Semiconductor manufactures products and uses packing materials that meet the provisions of the Customer Products Stewardship Specification (CSP-9-111C2) and the Banned Substances and Materials of Interest Specification (CSP-9-111S2) and contain no "Banned Substances" as defined in CSP-9-111S2.



**National Semiconductor**  
**Americas Customer**  
**Support Center**  
 Email: [new.feedback@nsc.com](mailto:new.feedback@nsc.com)  
 Tel: 1-800-272-9959

**National Semiconductor**  
**Europe Customer Support Center**  
 Fax: +49 (0) 180-530 85 86  
 Email: [europe.support@nsc.com](mailto:europe.support@nsc.com)  
 Deutsch Tel: +49 (0) 69 9508 6208  
 English Tel: +44 (0) 870 24 0 2171  
 Français Tel: +33 (0) 1 41 91 8790

**National Semiconductor**  
**Asia Pacific Customer**  
**Support Center**  
 Email: [ap.support@nsc.com](mailto:ap.support@nsc.com)

**National Semiconductor**  
**Japan Customer Support Center**  
 Fax: 81-3-5639-7507  
 Email: [jpn.feedback@nsc.com](mailto:jpn.feedback@nsc.com)  
 Tel: 81-3-5639-7560

Copyright © Each Manufacturing Company.

All Datasheets cannot be modified without permission.

This datasheet has been download from :

[www.AllDataSheet.com](http://www.AllDataSheet.com)

100% Free DataSheet Search Site.

Free Download.

No Register.

Fast Search System.

[www.AllDataSheet.com](http://www.AllDataSheet.com)