

Silicon Power Rectifier S/R42 Series

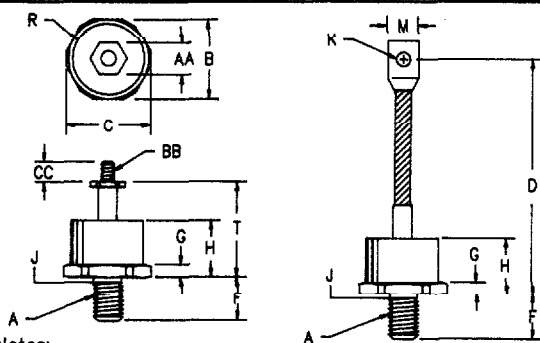

- Notes:
 1. 3/8-24 UNF-3A
 2. Full threads within 2 1/2 threads
 3. Standard polarity: Stud is Cathode
 Reverse polarity: Stud is Anode

Dim.	Inches		Millimeter		Notes
	Minimum	Maximum	Minimum	Maximum	
A	---	---	---	---	1
B	1.050	1.060	26.67	26.92	
C	---	1.166	---	29.61	
D	4.30	4.70	109.22	119.38	
F	.610	.640	15.49	16.25	
G	.213	.233	5.41	5.66	
H	---	.745	---	18.92	
J	.344	.373	8.74	9.47	2
K	.276	.286	7.01	7.26	
M	.465	.515	11.81	13.08	
R	---	.850	---	21.59	Die
T	1.426	---	36.22	---	
AA	.427	.437	10.84	11.09	
BB	---	---	---	---	3
CC	.407	---	10.33	---	

D0205AA (D08)

Microsemi Catalog Number	JEDEC Numbers	Peak Reverse Voltage
*S4210	1N412B, 1N1397, 1N2427, 1N2437, 1N3140,	100V
	1N3288, 1N4878	
*S4220	1N413B, 1N1399, 1N2429, 1N2439, 1N3142,	200V
	1N3289, 1N3972	
*S4230	1N1400, 1N2431, 1N2441, 1N3290	300V
*S4240	1N1401, 1N2433, 1N2443, 1N3921, 1N3973	400V
*S4250	1N1402, 1N2434, 1N2444, 1N3292	500V
*S4260	1N1403, 1N2435, 1N2445, 1N3293, 1N3974	600V
*S4280	1N3294, 1N3975	800V
*S42100	1N3295	1000V
*S42120	1N3296	1200V
*S42140		1400V
*S42160		1600V

*Change S to R in part number for Reverse Polarity
 Add the suffix TS to the end of the part number if a Top Stud is desired

- Soft recovery
- Glass Passivated Die
- 2000 Amps Surge Rating
- Glass to metal construction
- VRRM to 1600V
- Excellent reliability

Electrical Characteristics

Average forward current	$I_F(AV)$ 125 Amps	$T_C = 146^\circ C$, Half Sine Wave, $R_{\theta JC} = 0.40^\circ C/W$
Maximum surge current	I_{FSM} 2000 Amps	8.3ms, half sine, $T_J = 200^\circ C$
Max $I^2 t$ for fusing	$I^2 t$ 16800 $A^2 s$	
Max peak forward voltage	V_{FM} 1.2 Volts	$I_{FM} = 200A; T_J = 25^\circ C$
Max peak reverse current	I_{RM} 200 μA	$V_{RRM}, T_J = 25^\circ C$
Max peak reverse current	I_{RM} 5.0 mA	$V_{RRM}, T_J = 150^\circ C$
Max Recommended Operating Frequency	7.5kHz	

*Pulse test: Pulse width 300 μsec . Duty cycle 2%

Thermal and Mechanical Characteristics

Storage temperature range	ISTG	$-65^\circ C$ to $200^\circ C$
Operating junction temp range	T_J	$-65^\circ C$ to $200^\circ C$
Maximum thermal resistance	$R_{\theta JC}$	0.40 $^\circ C/W$ Junction to Case
Typical thermal resistance	$R_{\theta JC}$	0.35 $^\circ C/W$ Junction to Case
Mounting torque		100 Inch pounds maximum
Weight		2.75 ounces (78 grams) typical

Microsemi Corp.
Colorado

S/R42

Figure 1
Typical Forward Characteristics

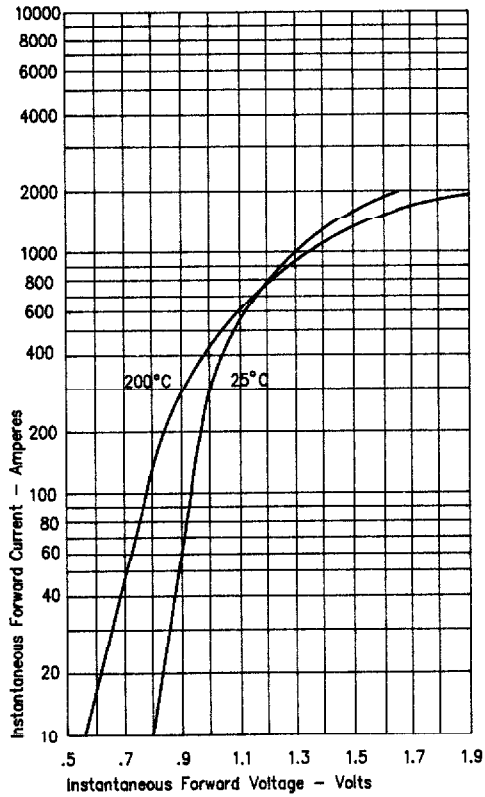

Figure 3
Forward Current Derating

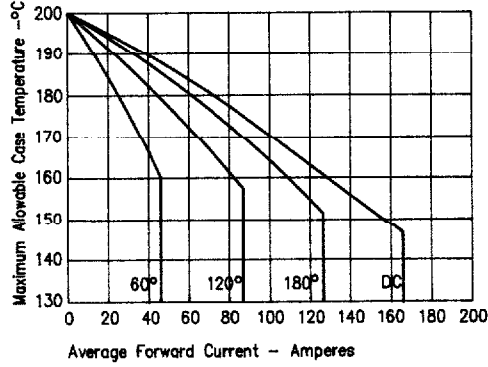

Figure 4
Maximum Forward Power Dissipation

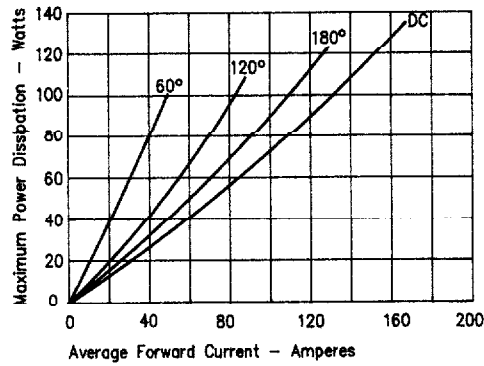

Figure 2
Typical Reverse Characteristics

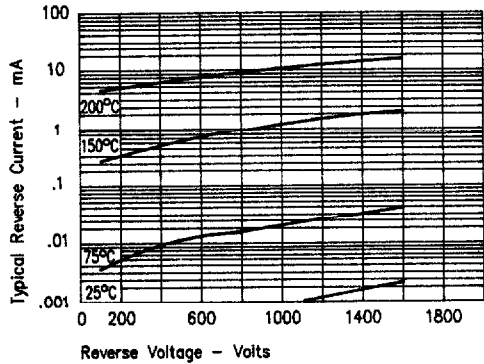
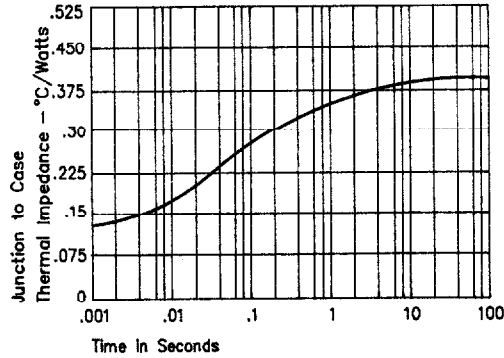
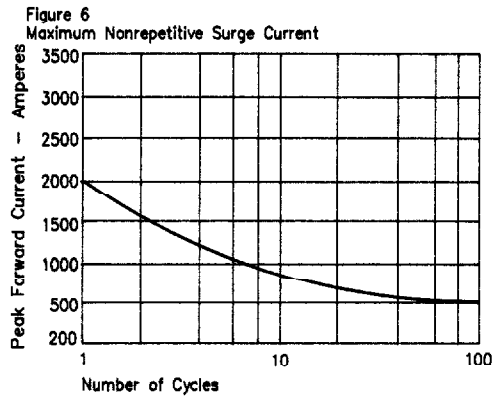

Figure 5
Transient Thermal Impedance



S/R42

|



Copyright © Each Manufacturing Company.

All Datasheets cannot be modified without permission.

This datasheet has been download from :

www.AllDataSheet.com

100% Free DataSheet Search Site.

Free Download.

No Register.

Fast Search System.

www.AllDataSheet.com