

1.25 Amp, Planar

FEATURES

- Available as Either "JAN" or Standard Types
- Operating D.C. Current Range: 5 to 1250mA
- Pulse Currents: to 30A
- Voltage Ratings: to 200V
- Maximum Trigger Current: 0.2mA
- Maximum Trigger Voltage: 0.8V
- All Leads Isolated from Case
- Maximum θ_{J-C} : 20°C/W

DESCRIPTION

These are premium PNP controlled switches intended for use in applications requiring a high degree of reliability assurance. The JAN types are specified under MIL-S-19500/198, and are included in MIL-STD-701 as recommended types for military usage.

This series is useful in a wide variety of applications including: safety, arming and detonating circuits; timing and programming circuits; protective and warning circuits; driving relays; driving indicator lamps, encoding and decoding circuits; replacing relays, thyatron, and megamps; servo motor control; pulse generation; plus many others.

8

ABSOLUTE MAXIMUM RATINGS

	2N1870A JAN2N1870A	2N1871A JAN2N1871A	2N1872A JAN2N1872A	2N1873A —	2N1874A JAN2N1874A
Repetitive Peak Off-State Voltage, V_{DRM}	30V	60V	100V	150V	200V
Repetitive Peak Reverse Voltage, V_{RRM}	30V	60V	100V	150V	200V
D.C. On-State Current, I_T					
100°C Ambient			250mA		
100°C Case			1.25A		
Repetitive Peak On-State Current, I_{TRM}			up to 30A		
Peak One Cycle Surge (Non-Rep.) On-State Current, I_{TSM}			15A		
Peak Gate Current, I_{GM}			250mA		
Average Gate Current, $I_{C(AV)}$			25mA		
Reverse Gate Voltage, V_{GR}			5V		
Thermal Resistance, Junction to Case, $R\theta_{J-C}$			20°C/W		
Operating and Storage Temperature Range			-65°C to +150°C		

MECHANICAL SPECIFICATIONS

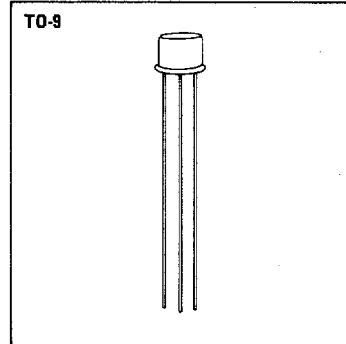
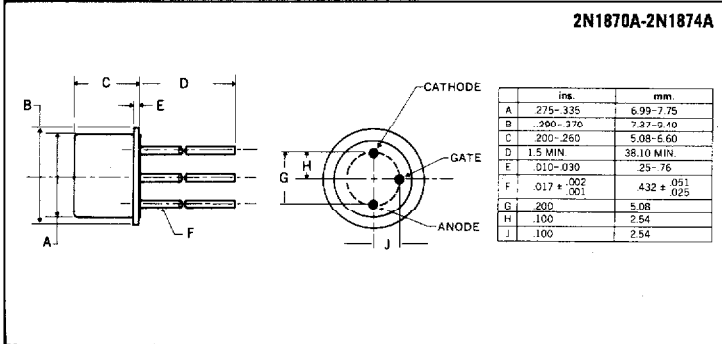

Microsemi Corp.
Watertown
The diode experts

ELECTRICAL SPECIFICATIONS (at 25°C unless noted)†

Test	Symbol	Min.	Typical	Max.	Units	Test Conditions
Subgroup 1 (Visual and Mechanical)						
Subgroup 2 (25°C Tests)						
Off-State Current	I_{DRM}	—	0.5	10	μA	$R_{GK} = 1K, V_{DRM} = + \text{Rating}$
Reverse Current	I_{RRM}	—	0.5	10	μA	$R_{GK} = 1K, V_{RRM} = - \text{Rating}$
Gate Trigger Voltage	V_{GT}	0.4	0.55	0.8	V	$R_{GS} = 100 \text{ ohms}, V_D = 5V$
Gate Trigger Current	I_{GT}	—	30	200	μA	$R_{GS} > 10K \text{ ohms}, V_D = 5V$
On-State Voltage	V_{TM}	—	1.8	2.5	V	$I_{TM} = 2A \text{ (pulse test)}$
Off-State Voltage — Critical of Rise	dv_c/dt	100	—	—	V/ μs	<i>Specified test circuit</i>
Reverse Gate Current	I_{GR}	—	0.5	10	μA	$V_{GRM} = 5V, \text{ anode open}$
Holding Current	I_H	0.3	—	5.0	mA	$I_G = -150\mu A, V_D = 5V$
Subgroup 3 (125°C Tests)						
High Temp. Off-State Current	I_{DRM}	—	15	100	μA	$R_{GK} = 1K, V_{DRM} = + \text{Rating}$
High Temp. Reverse Current	I_{RRM}	—	15	100	μA	$R_{GK} = 1K, V_{RRM} = - \text{Rating}$
High Temp. Gate Non-Trigger Voltage	V_{GD}	0.2	—	—	V	$R_{GS} = 100 \text{ ohms}, V_D = 5V$
High Temp. Holding Current	I_H	0.2	—	—	mA	$I_G = -150\mu A, V_D = 5V$
Subgroup 4 (-65°C Tests)						
Low Temp. Gate Trigger Voltage	V_{GT}	—	—	1.0	V	$R_{GK} = 100 \text{ ohms}, V_D = 5V$
Low Temp. Gate Trigger Current	I_{GT}	—	—	500	μA	$R_{GK} > 10K \text{ ohms}, V_D = 5V$
Low Temp. Holding Current	I_H	—	—	15	mA	$I_G = -150\mu A, V_D = 5V$

†All values in this table are JEDEC registered.

Note: Voltage ratings apply over the full operating temperature range, provided the gate is connected to the cathode through a resistor, 1 K or smaller, or other adequate gate bias is used.

Triggering and Bias Stabilization

1. Gate Trigger Current

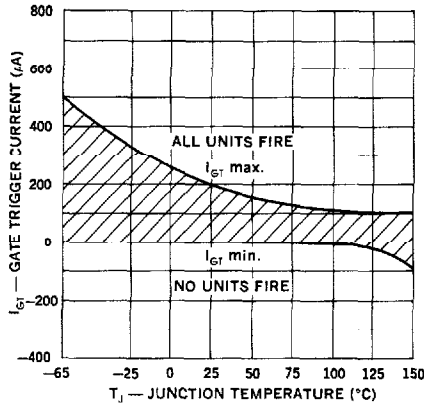

2. Gate Trigger Voltage

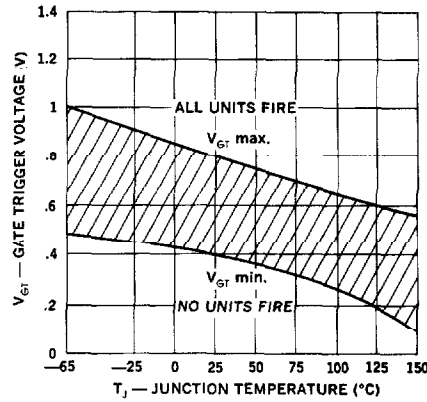

ELECTRICAL SPECIFICATIONS (at 25°C unless noted)†

Test	Symbol	Min.	Typical	Max.	Units	Test Conditions
Subgroup 1 (Visual and Mechanical)						
Subgroup 2 (25°C Tests)						
Off-State Current	I_{DRM}	—	0.5	10	μA	$R_{GK} = 1K, V_{DRM} = + \text{Rating}$
Reverse Current	I_{RRM}	—	0.5	10	μA	$R_{GK} = 1K, V_{RRM} = - \text{Rating}$
Gate Trigger Voltage	V_{GT}	0.4	0.55	0.8	V	$R_{GK} = 100 \text{ ohms}, V_D = 5V$
Gate Trigger Current	I_{GT}	—	30	200	μA	$R_{GS} > 10K \text{ ohms}, V_D = 5V$
On-State Voltage	V_{TM}	—	1.8	2.5	V	$I_{TM} = 2A \text{ (pulse test)}$
Off-State Voltage — Critical of Rise	dv_V/dt	100	—	—	V/ μs	Specified test circuit
Reverse Gate Current	I_{GR}	—	0.5	10	μA	$V_{GRM} = 5V, \text{ anode open}$
Holding Current	I_H	0.3	—	5.0	mA	$I_G = -150\mu A, V_D = 5V$
Subgroup 3 (125°C Tests)						
High Temp. Off-State Current	I_{DRM}	—	15	100	μA	$R_{GK} = 1K, V_{DRM} = + \text{Rating}$
High Temp. Reverse Current	I_{RRM}	—	15	100	μA	$R_{GK} = 1K, V_{RRM} = - \text{Rating}$
High Temp. Gate Non-Trigger Voltage	V_{GD}	0.2	—	—	V	$R_{GS} = 100 \text{ ohms}, V_D = 5V$
High Temp. Holding Current	I_H	0.2	—	—	mA	$I_G = -150\mu A, V_D = 5V$
Subgroup 4 (-65°C Tests)						
Low Temp. Gate Trigger Voltage	V_{GT}	—	—	1.0	V	$R_{GK} = 100 \text{ ohms}, V_D = 5V$
Low Temp. Gate Trigger Current	I_{GT}	—	—	500	μA	$R_{GK} > 10K \text{ ohms}, V_D = 5V$
Low Temp. Holding Current	I_H	—	—	15	mA	$I_G = -150\mu A, V_{AA} = 5V$

†All values in this table are JEDEC registered.

Note: Voltage ratings apply over the full operating temperature range, provided the gate is connected to the cathode through a resistor, 1 K or smaller, or other adequate gate bias is used.

Triggering and Bias Stabilization

1. Gate Trigger Current

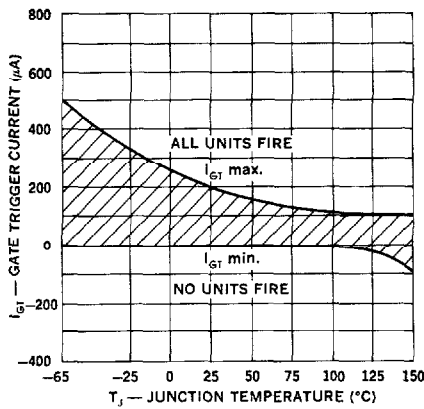

2. Gate Trigger Voltage

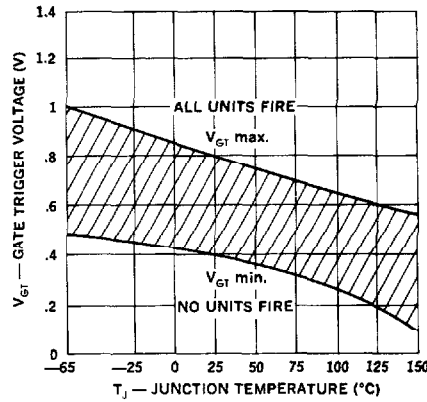

Holding Current

1. Max. Holding Current (Current Bias)

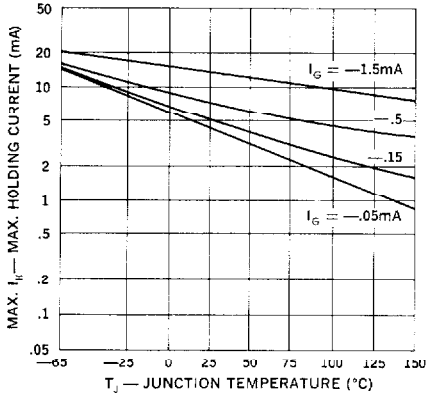

2. Max. Holding Current (Resistor Bias)

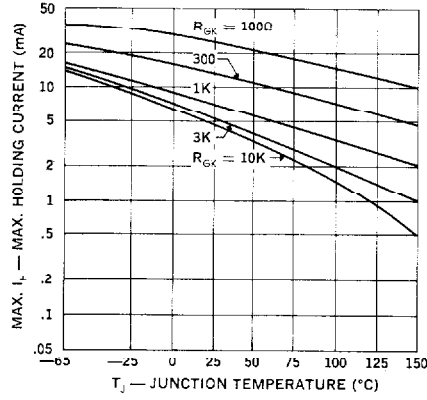

8

3. Min. Holding Current (Current Bias)

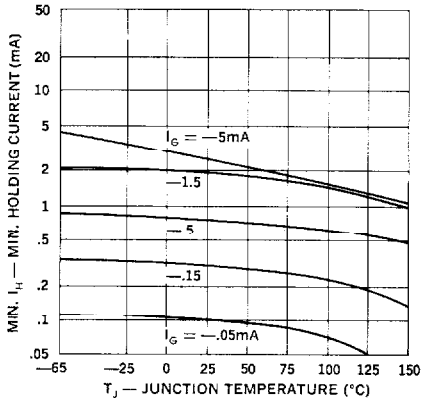

4. Min. Holding Current (Resistor Bias)

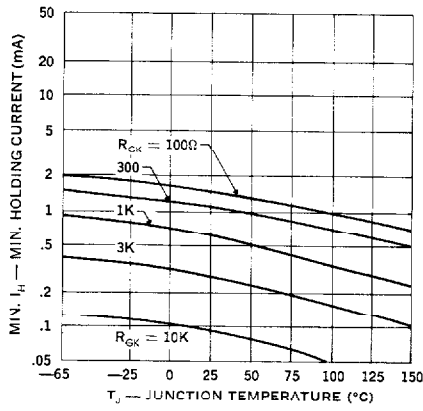

Current Ratings — Thermal Design

1. On-State Current vs. Voltage

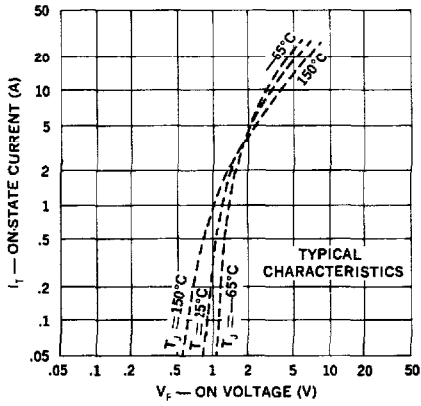

2. Peak Current vs. Case Temperature

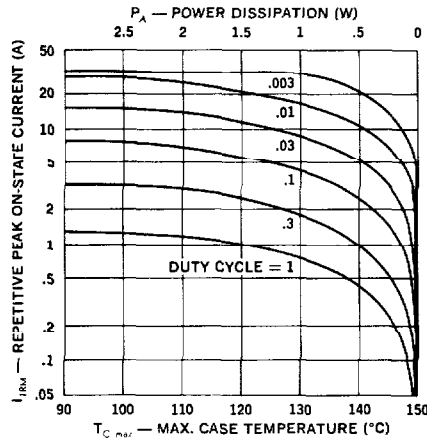

3. Peak Current vs. Ambient Temperature

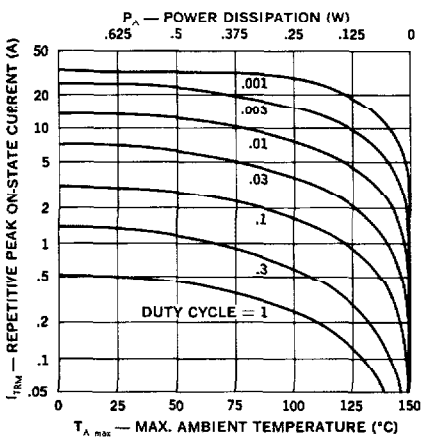

4. Surge Current vs. Time

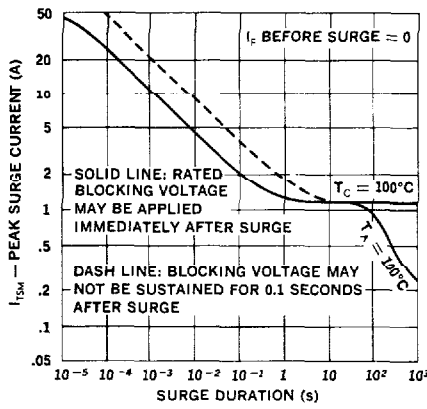

5. Average Current vs. Case Temperature

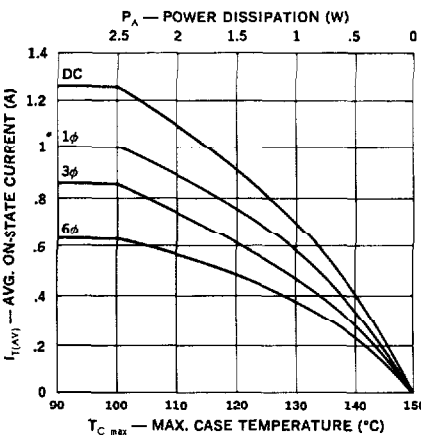

6. Average Current vs. Ambient Temperature

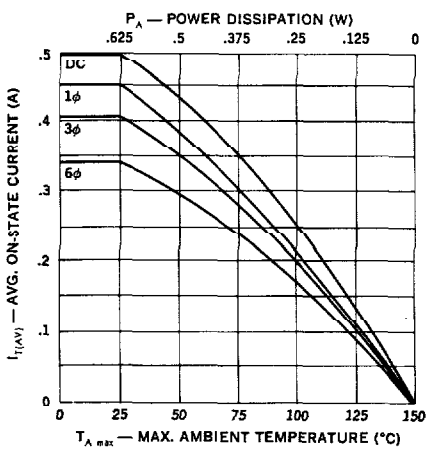

Copyright © Each Manufacturing Company.

All Datasheets cannot be modified without permission.

This datasheet has been download from :

www.AllDataSheet.com

100% Free DataSheet Search Site.

Free Download.

No Register.

Fast Search System.

www.AllDataSheet.com