

**FAIRCHILD**

A Schlumberger Company

**2N6755/2N6756 T-39-11**  
**N-Channel Power MOSFETs,**  
**14 A, 60 V/100 V**

Power And Discrete Division

**Description**

These devices are n-channel, enhancement mode, power MOSFETs designed especially for high power, high speed applications, such as switching power supplies, UPS, AC and DC motor controls, relay and solenoid drivers and high energy pulse circuits.

- $V_{GS}$  Rated at  $\pm 20$  V
- Silicon Gate for Fast Switching Speeds
- $I_{DSS}$ ,  $R_{DS(on)}$ , Specified at Elevated Temperature
- Rugged
- Low Drive Requirements
- Ease of Paralleling

TO-204AA

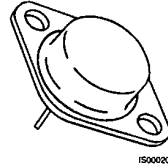

2N6755  
2N6756

2

**Maximum Ratings**

Symbol	Characteristic	Rating 2N6756	Rating 2N6755	Unit
$V_{DSS}$	Drain to Source Voltage	100	60	V
$V_{DGR}$	Drain to Gate Voltage $R_{GS} = 1 M\Omega$	100	60	V
$V_{GS}$	Gate to Source Voltage	$\pm 20$	$\pm 20$	V
$T_J, T_{stg}$	Operating Junction and Storage Temperatures	-55 to +150	-55 to +150	$^{\circ}C$
$T_L$	Maximum Lead Temperature for Soldering Purposes, 1/16" From Case for 10 s	300	300	$^{\circ}C$

**Maximum On-State Characteristics**

$R_{DS(on)}$	Static Drain-to-Source On Resistance	0.18	0.25	$\Omega$
$I_D$	Drain Current Continuous at $T_C = 25^{\circ}C$ Continuous at $T_C = 100^{\circ}C$	14 9	12 8	A
$I_{DM}$	Pulsed	$30^2$	$25^2$	

**Maximum Thermal Characteristics**

$R_{\theta JC}$	Thermal Resistance, Junction to Case	1.67	1.67	$^{\circ}C/W$
$P_D$	Total Power Dissipation at $T_C = 25^{\circ}C$	75	75	W
	Linear Derating Factor	0.6	0.6	W/ $^{\circ}C$

**Notes**

All values are JEDEC registered except as noted. For information concerning connection diagram and package outline, refer to Section 7.

84 DE 3469674 0027791 1

2N6755/2N6756

T-39-11

**Electrical Characteristics** ( $T_C = 25^\circ\text{C}$  unless otherwise noted)

Symbol	Characteristic	Min	Max	Unit	Test Conditions
<b>Off Characteristics</b>					
$V_{(BR)DSS}$	Drain Source Breakdown Voltage 2N6756 2N6755			V	$V_{GS} = 0\text{ V}$ , $I_D = 1\text{ mA}$
		100 <sup>2</sup>			
		60 <sup>2</sup>			
$I_{DSS}$	Zero Gate Voltage Drain Current		1	mA	$V_{DS} = \text{Rated } V_{DSS}$ , $V_{GS} = 0\text{ V}$ $V_{DS} = \text{Rated } V_{DSS}$ , $V_{GS} = 0\text{ V}$ , $T_C = 125^\circ\text{C}$
			4		
$I_{GSS}$	Gate-Body Leakage Current		$\pm 100$	nA	$V_{GS} = \pm 20\text{ V}$ , $V_{DS} = 0\text{ V}$
<b>On Characteristics</b>					
$V_{GS(th)}$	Gate Threshold Voltage	2.0	4.0	V	$I_D = 1\text{ mA}$ , $V_{DS} = V_{GS}$
$R_{DS(on)}$	Static Drain-Source On-Resistance <sup>1</sup> 2N6756 2N6755		0.18	$\Omega$	$V_{GS} = 10\text{ V}$ $I_D = 9\text{ A}$ $I_D = 8\text{ A}$
			0.25		
	2N6756 2N6755		0.33	$\Omega$	$V_{GS} = 10\text{ V}$ , $T_C = 125^\circ\text{C}$ $I_D = 9\text{ mA}$ $I_D = 8\text{ A}$
			0.45		
$V_{DS(on)}$	Drain-Source On-Voltage <sup>1</sup> 2N6756 2N6755		2.52	V	$V_{GS} = 10\text{ V}$ ; $I_D = 14\text{ A}$ $V_{GS} = 10\text{ V}$ ; $I_D = 12\text{ A}$
			3.0		
$g_{fs}$	Forward Transconductance <sup>1</sup>	4.0	12	S ( $\Omega$ )	$V_{DS} = 10\text{ V}$ , $I_D = 9\text{ A}$
<b>Dynamic Characteristics</b>					
$C_{iss}$	Input Capacitance	350	800	pF	$V_{DS} = 25\text{ V}$ , $V_{GS} = 0\text{ V}$ $f = 1.0\text{ MHz}$
$C_{oss}$	Output Capacitance	150	500	pF	
$C_{rss}$	Reverse Transfer Capacitance	50	150	pF	
<b>Switching Characteristics</b> ( $T_C = 25^\circ\text{C}$ , Figures 9, 10)					
$t_{d(on)}$	Turn-On Delay Time		30	ns	$V_{DD} = 36\text{ V}$ , $I_D = 9\text{ A}$ $V_{GS} = 10\text{ V}$ , $R_{GEN} = 15\ \Omega$ $R_{GS} = 15\ \Omega$
$t_r$	Rise Time		75	ns	
$t_{d(off)}$	Turn-Off Delay Time		40	ns	
$t_f$	Fall Time		45	ns	
$Q_g$	Total Gate Charge		30 <sup>2</sup>	nC	$V_{GS} = 10\text{ V}$ , $I_D = 18\text{ A}$ $V_{DD} = 55\text{ V}$

**Electrical Characteristics (Cont.)** ( $T_C = 25^\circ\text{C}$  unless otherwise noted)

Symbol	Characteristic	Min	Typ	Max	Unit	Test Conditions
<b>Source-Drain Diode Characteristics</b>						
$I_S$	Continuous Source Current 2N6756 2N6755			14 12	A	
$I_{SM}$	Pulsed Source Current 2N6756 2N6755			$30^2$ $25^2$	A	
$V_{SD}$	Diode Forward Voltage 2N6756 2N6755	0.90		1.8	V	$I_S = 14\text{ A}; V_{GS} = 0\text{ V}$
		0.85		1.7	V	$I_S = 12\text{ A}; V_{GS} = 0\text{ V}$
$t_{rr}$	Reverse Recovery Time		$300^2$		ns	$V_{GS} = 0\text{ V}, T_J = 150^\circ\text{C}$ $I_F = I_{SM}, dI_F/dt = 100\text{ A}/\mu\text{S}$
$Q_{RR}$	Reverse Recovery Charge		$4.0^2$		$\mu\text{C}$	$V_{GS} = 0\text{ V}, T_J = 150^\circ\text{C}$ $I_F = I_{SM}, dI_F/dt = 100\text{ A}$

**Notes**

1. Pulse test: Pulse width  $\leq 300\ \mu\text{s}$ , Duty cycle  $\leq 1\%$
2. Non-JEDEC registered value.

**Typical Performance Curves**

**Figure 1 Output Characteristics**

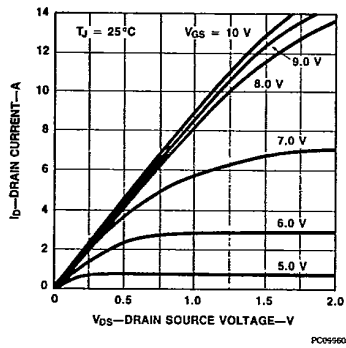

**Figure 2 Static Drain to Source Resistance vs Drain Current**

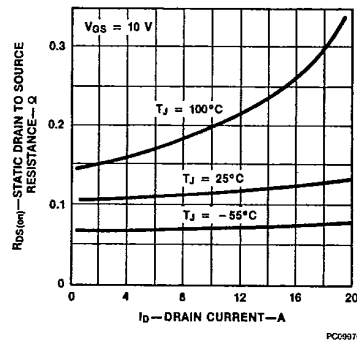

Typical Performance Curves (Cont.)

Figure 3 Transfer Characteristics

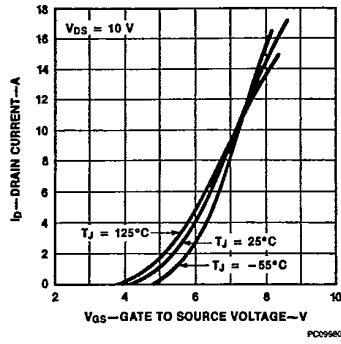

Figure 4 Temperature Variation of Gate to Source Threshold Voltage

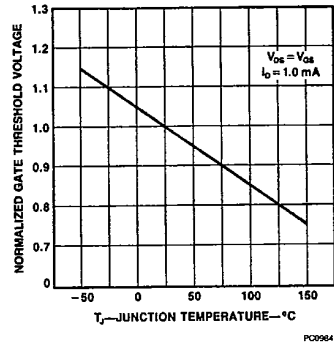

Figure 5 Capacitance vs Drain to Source Voltage

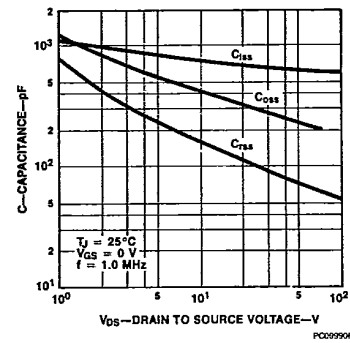

Figure 6 Gate to Source Voltage vs Total Gate Charge

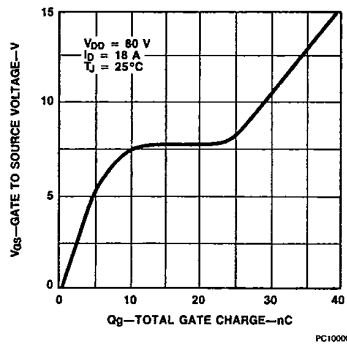

Figure 7 Forward Biased Safe Operating Area

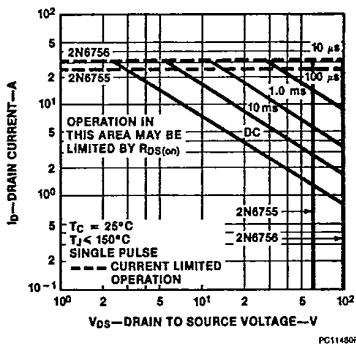
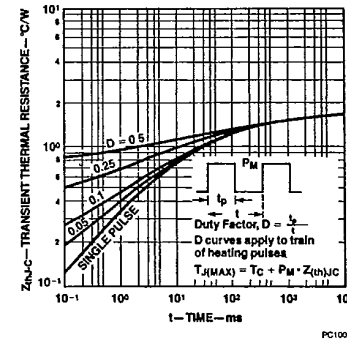
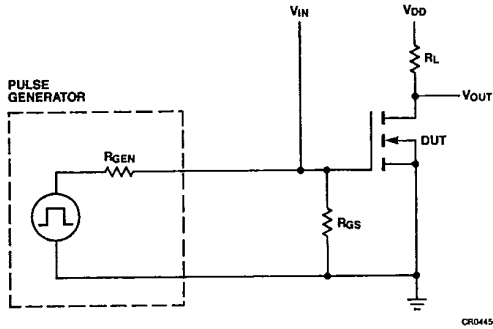

Figure 8 Transient Thermal Resistance vs Time



Typical Electrical Characteristics

Figure 9 Switching Test Circuit



CR04450F

Figure 10 Switching Waveforms

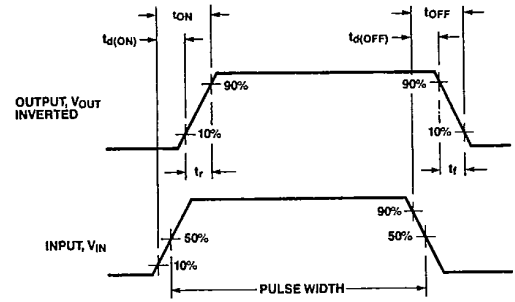

WF00600F

2

Copyright © Each Manufacturing Company.

All Datasheets cannot be modified without permission.

This datasheet has been download from :

[www.AllDataSheet.com](http://www.AllDataSheet.com)

100% Free DataSheet Search Site.

Free Download.

No Register.

Fast Search System.

[www.AllDataSheet.com](http://www.AllDataSheet.com)