

FAIRCHILD

A Schlumberger Company

2N6761/2N6762
N-Channel Power MOSFETs,
4.5 A, 450 V/500 V

T-39-11

Power And Discrete Division

Description

These devices are n-channel, enhancement mode, power MOSFETs designed especially for high voltage, high speed applications, such as off-line switching power supplies, UPS, AC and DC motor controls, relay and solenoid drivers.

TO-204AA

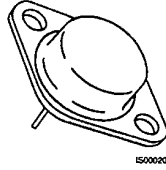

IS00020F

- V_{GS} Rated at ± 20 V
- Silicon Gate for Fast Switching Speeds
- I_{DSS} , $R_{DS(on)}$, SOA and $V_{GS(th)}$ Specified at Elevated Temperature
- Rugged

2N6761
 2N6762

Maximum Ratings

Symbol	Characteristic	Rating 2N6762	Rating 2N6761	Unit
V_{DSS}	Drain to Source Voltage	500	450	V
V_{DGR}	Drain to Gate Voltage $R_{GS} = 1.0 \text{ M}\Omega$	500	450	V
V_{GS}	Gate to Source Voltage	± 20	± 20	V
T_J, T_{stg}	Operating Junction and Storage Temperatures	-55 to +150	-55 to +150	$^{\circ}\text{C}$
T_L	Maximum Lead Temperature for Soldering Purposes, 1/16" From Case for 10 s	300	300	$^{\circ}\text{C}$

Maximum On-State Characteristics

$R_{DS(on)}$	Static Drain-to-Source On Resistance	1.5	2.0	Ω
I_D	Drain Current Continuous at $T_C = 25^{\circ}\text{C}$	4.5	4.0	A
	Continuous at $T_C = 100^{\circ}\text{C}$	3.0	2.5	
I_{DM}	Pulsed	7.0^2	6.0^2	

Maximum Thermal Characteristics

$R_{\theta JC}$	Thermal Resistance, Junction to Case	1.67	1.67	$^{\circ}\text{C}/\text{W}$
P_D	Total Power Dissipation at $T_C = 25^{\circ}\text{C}$	75	75	W
	at $T_C = 100^{\circ}\text{C}$	30	30	
	Linear Derating Factor	0.6	0.6	$\text{W}/^{\circ}\text{C}$

Notes

All values are JEDEC registered except as noted. For information concerning connection diagram and package outline, refer to Section 7.

Electrical Characteristics ($T_C = 25^\circ\text{C}$ unless otherwise noted)

Symbol	Characteristic	Min	Max	Unit	Test Conditions
Off Characteristics					
$V_{(BR)DSS}$	Drain Source Breakdown Voltage ¹ 2N6762 2N6761			V	$V_{GS} = 0\text{ V}, I_D = 4\text{ mA}$
		500 ²			
		450 ²			
I_{DSS}	Zero Gate Voltage Drain Current		1	mA	$V_{DS} = \text{Rated } V_{DSS}, V_{GS} = 0\text{ V}$ $V_{DS} = 0.8 \times \text{Rated } V_{DSS}, V_{GS} = 0\text{ V}, T_C = 125^\circ\text{C}$
			4		
I_{GSS}	Gate-Body Leakage Current		± 100	nA	$V_{GS} = \pm 20\text{ V}, V_{DS} = 0\text{ V}$
On Characteristics					
$V_{GS(th)}$	Gate Threshold Voltage	2.0	4.0	V	$I_D = 1.0\text{ mA}, V_{DS} = V_{GS}$
$R_{DS(on)}$	Static Drain-Source On-Resistance ¹ 2N6762 2N6761 2N6762 2N6761			Ω	$V_{GS} = 10\text{ V}$ $I_D = 3.0\text{ A}$ $I_D = 2.5\text{ A}$ $I_D = 3.0\text{ A}, T_C = 125^\circ\text{C}$ $I_D = 2.5\text{ A}, T_C = 125^\circ\text{C}$
			1.5		
			2.0		
			3.3		
			4.4		
$V_{DS(on)}$	Drain-Source On-Voltage ¹ 2N6762 2N6761		7.7	V	$V_{GS} = 10\text{ V}$ $I_D = 4.5\text{ A}$ $I_D = 4.0\text{ A}$
			8.0		
g_{fs}	Forward Transconductance ¹	2.5	7.5	S (Ω)	$V_{DS} = 15\text{ V}, I_D = 3.0\text{ A}$
Dynamic Characteristics					
C_{iss}	Input Capacitance	350	800	pF	$V_{DS} = 25\text{ V}, V_{GS} = 0\text{ V}$ $f = 1.0\text{ MHz}$
C_{dss}	Output Capacitance	25	200	pF	
C_{res}	Reverse Transfer Capacitance	15	60	pF	
Switching Characteristics ($T_C = 25^\circ\text{C}$, Figures 9, 10)					
$t_{d(on)}$	Turn-On Delay Time		30	ns	$V_{DD} = 225\text{ V}, I_D = 3.0\text{ A}$ $V_{GS} = 10\text{ V}, R_{GEN} = \Omega$ $R_{GS} = 15\ \Omega$
t_r	Rise Time		30	ns	
$t_{d(off)}$	Turn-Off Delay Time		55	ns	
t_f	Fall Time		30	ns	
Q_g	Total Gate Charge		30 ²	nC	$V_{GS} = 10\text{ V}, I_D = 7.0\text{ A}$ $V_{DD} = 180\text{ V}$

Electrical Characteristics (Cont.) ($T_C = 25^\circ\text{C}$ unless otherwise noted)

Symbol	Characteristic	Min	Typ	Max	Unit	Test Conditions
Source-Drain Diode Characteristics						
I_S	Continuous Source Current 2N6762 2N6761			4.5 4.0	A	
I_{SM}	Pulsed Source Current 2N6762 2N6761			7.0 6.0	A	
V_{SD}	Diode Forward Voltage 2N6762 2N6761	0.7 0.65		1.4 1.3	V	$V_{GS} = 0\text{ V}$ $I_S = 4.5\text{ A}$ $I_S = 4.0\text{ A}$
t_{rr}	Reverse Recovery Time		520^2		ns	$V_{GS} = 0\text{ V}$, $T_J = 150^\circ\text{C}$ $I_F = I_{SM}$, $dI_F/dt = 100\text{ A}/\mu\text{S}$
Q_{RR}	Reverse Recovery Charge		7.0^2		μC	$V_{GS} = 0\text{ V}$, $T_J = 150^\circ\text{C}$ $I_F = I_{SM}$, $dI_F/dt = 100\text{ A}/\mu\text{S}$

Notes

1. Pulse test: Pulse width $\leq 300\ \mu\text{s}$, Duty cycle $\leq 1\%$
2. Non-JEDEC registered value.

Typical Performance Curves

Figure 1 Output Characteristics

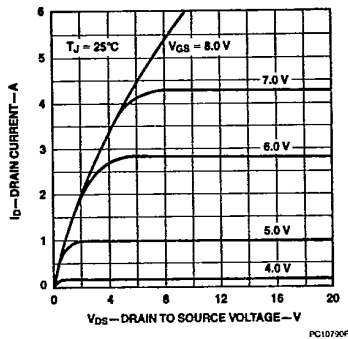
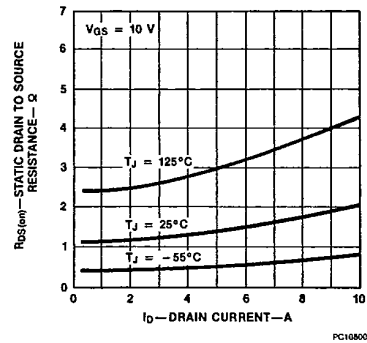

Figure 2 Static Drain to Source Resistance vs Drain Current



2N6761/2N6762

T-39-11

Typical Performance Curves (Cont.)

Figure 3 Transfer Characteristics

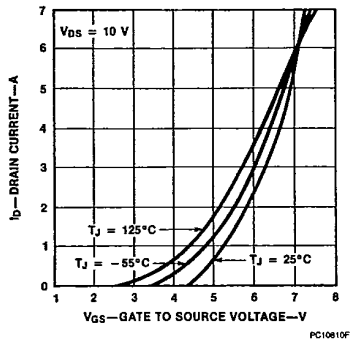

Figure 4 Temperature Variation of Gate to Source Threshold Voltage

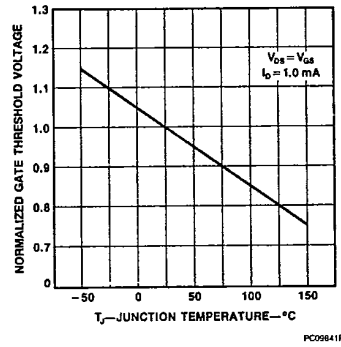

Figure 5 Capacitance vs Drain to Source Voltage

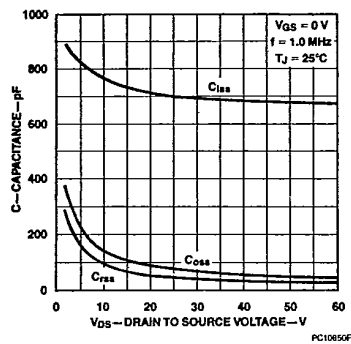

Figure 6 Gate to Source Voltage vs Total Gate Charge

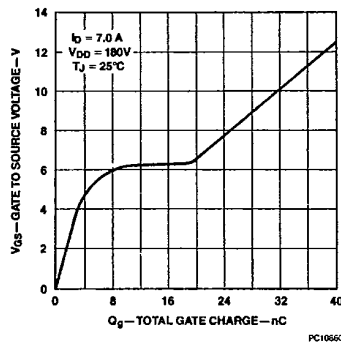

Figure 7 Forward Biased Safe Operating Area

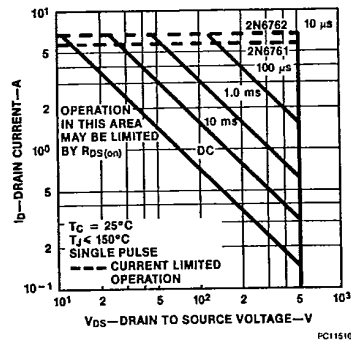
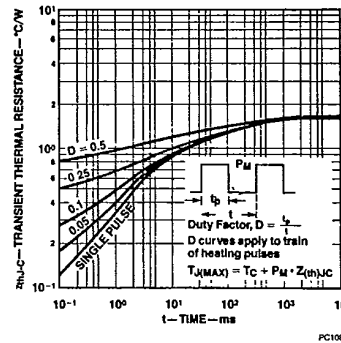

Figure 8 Transient Thermal Resistance vs Time



Typical Electrical Characteristics

Figure 9 Switching Test Circuit

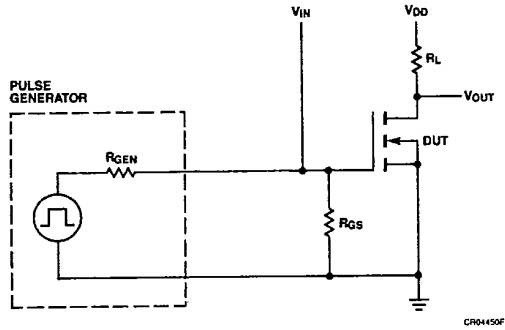
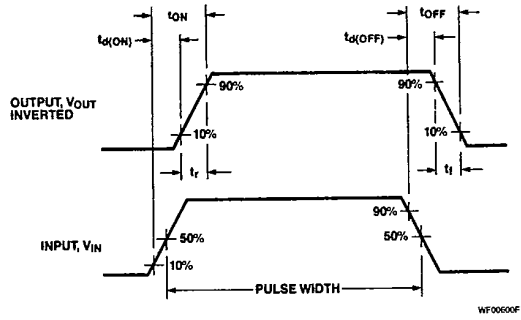

Figure 10 Switching Waveforms



Copyright © Each Manufacturing Company.

All Datasheets cannot be modified without permission.

This datasheet has been download from :

www.AllDataSheet.com

100% Free DataSheet Search Site.

Free Download.

No Register.

Fast Search System.

www.AllDataSheet.com