



A Schlumberger Company

**2N6769/2N6770**  
**N-Channel Power MOSFETs,**  
**12 A, 450 V/500 V**

Power And Discrete Division

T-39-13

**Description**

These devices are n-channel, enhancement mode, power MOSFETs designed especially for high voltage, high speed applications, such as off-line switching power supplies, UPS, AC and DC motor controls, relay and solenoid drivers.

- $V_{GS}$  Rated at  $\pm 20$  V
- Silicon Gate for Fast Switching Speeds
- $I_{DSS}$ ,  $V_{DS(on)}$ , SOA and  $V_{GS(th)}$  Specified at Elevated Temperature
- Rugged

TO-204AA

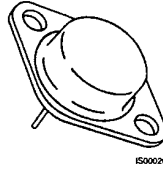

2N6769  
2N6770

**Maximum Ratings**

Symbol	Characteristic	Rating 2N6770	Rating 2N6769	Unit
$V_{DSS}$	Drain to Source Voltage	500	450	V
$V_{DGR}$	Drain to Gate Voltage $R_{GS} = 1.0 \text{ M}\Omega$	500	450	V
$V_{GS}$	Gate to Source Voltage	$\pm 20$	$\pm 20$	V
$T_J, T_{slg}$	Operating Junction and Storage Temperatures	-55 to +150	-55 to +150	$^{\circ}\text{C}$
$T_L$	Maximum Lead Temperature for Soldering Purposes, 1/16" From Case for 10 s	300	300	$^{\circ}\text{C}$

**Maximum On-State Characteristics**

$R_{DS(on)}$	Static Drain-to-Source On Resistance	0.4	0.5	$\Omega$
$I_D$	Drain Current Continuous at $T_C = 25^{\circ}\text{C}$ Continuous at $T_C = 100^{\circ}\text{C}$	12 4.75	11 7.0	A
$I_{DM}$	Pulsed	$25^2$	$20^2$	

**Maximum Thermal Characteristics**

$R_{\theta JC}$	Thermal Resistance, Junction to Case	0.83	0.83	$^{\circ}\text{C}/\text{W}$
$P_D$	Total Power Dissipation at $T_C = 25^{\circ}\text{C}$ at $T_C = 100^{\circ}\text{C}$	150 60	150 60	W
	Linear Derating Factor	1.2	1.2	$\text{W}/^{\circ}\text{C}$

**Notes**

All values are JEDEC registered except as noted. For information concerning connection diagram and package outline, refer to Section 7.

**Electrical Characteristics** ( $T_C = 25^\circ\text{C}$  unless otherwise noted)

Symbol	Characteristic	Min	Max	Unit	Test Conditions
<b>Off Characteristics</b>					
$V_{(BR)DSS}$	Drain Source Breakdown Voltage <sup>1</sup>			V	$V_{GS} = 0\text{ V}, I_D = 4\text{ mA}$
	2N6770	500 <sup>2</sup>			
	2N6769	450 <sup>2</sup>			
$I_{DSS}$	Zero Gate Voltage Drain Current		1	mA	$V_{DS} = \text{Rated } V_{DSS}, V_{GS} = 0\text{ V}$ $V_{GS} = 0\text{ V}, T_C = 125^\circ\text{C}$
			4		
$I_{GSS}$	Gate-Body Leakage Current		$\pm 100$	nA	$V_{GS} = \pm 20\text{ V}, V_{DS} = 0\text{ V}$
<b>On Characteristics</b>					
$V_{GS(th)}$	Gate Threshold Voltage	2.0	4.0	V	$I_D = 1\text{ mA}, V_{DS} = V_{GS}$
$R_{DS(on)}$	Static Drain-Source On-Resistance <sup>1</sup>			$\Omega$	$V_{GS} = 10\text{ V}$ $I_D = 7.75\text{ A}$ $I_D = 7.0\text{ A}$ $I_D = 7.75\text{ A}, T_C = 125^\circ\text{C}$ $I_D = 7.0\text{ A}, T_C = 125^\circ\text{C}$
		2N6770	0.4		
		2N6769	0.5		
		2N6770	0.88		
	2N6769	1.10			
$V_{DS(on)}$	Drain-Source On-Voltage <sup>1</sup>			V	$V_{GS} = 10\text{ V}$ $I_D = 12\text{ A}$ $I_D = 11\text{ A}$
		2N6770	6.0		
	2N6769	6.0			
$g_{fs}$	Forward Transconductance	8.0	24	S ( $\Omega$ )	$V_{DS} = 15\text{ V}, I_D = 7.75\text{ A}$
<b>Dynamic Characteristics</b>					
$C_{iss}$	Input Capacitance	1000	3000	pF	$V_{DS} = 25\text{ V}, V_{GS} = 0\text{ V}$ $f = 1.0\text{ MHz}$
$C_{dss}$	Output Capacitance	200	600	pF	
$C_{rss}$	Reverse Transfer Capacitance	50	200	pF	
<b>Switching Characteristics</b> ( $T_C = 25^\circ\text{C}$ , Figures 9, 10)					
$t_{d(on)}$	Turn-On Delay Time		35	ns	$V_{DD} = 210\text{ V}, I_D = 7.75\text{ A}$ $V_{GS} = 10\text{ V}, R_{GEN} = 4.7\ \Omega$ $R_{GS} = 4.7\ \Omega$
$t_r$	Rise Time		50	ns	
$t_{d(off)}$	Turn-Off Delay Time		150	ns	
$t_f$	Fall Time		70	ns	
$Q_g$	Total Gate Charge		120 <sup>2</sup>	nC	$V_{GS} = 10\text{ V}, I_D = 16\text{ A}$ $V_{DD} = 400\text{ V}$

2

2N6769/2N6770

T-39-13

Electrical Characteristics (Cont.) ( $T_C = 25^\circ\text{C}$  unless otherwise noted)

Symbol	Characteristic	Min	Typ	Max	Unit	Test Conditions
<b>Source-Drain Diode Characteristics</b>						
$I_S$	Continuous Source Current 2N6770 2N6769			$12^2$ $11^2$	A	
$I_{SM}$	Pulsed Source Current 2N6770 2N6769			$25^2$ $20^2$	A	
$V_{SD}$	Diode Forward Voltage 2N6770 2N6769	0.80		1.6	V	$V_{GS} = 0\text{ V}$ $I_S = 12\text{ A}$
		0.75		1.5		$I_S = 11\text{ A}$
$t_{rr}$	Reverse Recovery Time		$1300^2$		ns	$V_{GS} = 0\text{ V}$ , $T_J = 150^\circ\text{C}$ $I_F = I_{SM}$ , $dI_F/dt = 100\text{ A}/\mu\text{s}$
$Q_{RR}$	Reverse Recovery Charge		$7.4^2$		$\mu\text{C}$	$V_{GS} = 0\text{ V}$ , $T_J = 150^\circ\text{C}$ $I_F = I_{SM}$ , $dI_F/dt = 100\text{ A}/\mu\text{s}$

Notes

1. Pulse test: Pulse width  $\leq 300\ \mu\text{s}$ , Duty cycle  $\leq 1\%$
2. Non-JEDEC registered value.

Typical Performance Curves

Figure 1 Output Characteristics

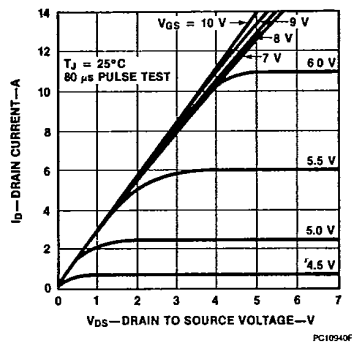
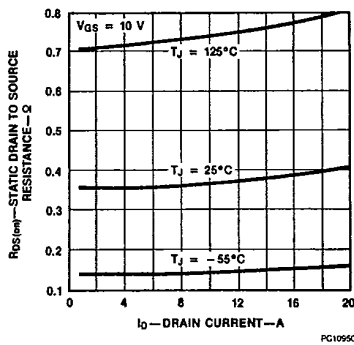

Figure 2 Static Drain to Source Resistance vs Drain Current



Typical Performance Curves (Cont.)

Figure 3 Transfer Characteristics

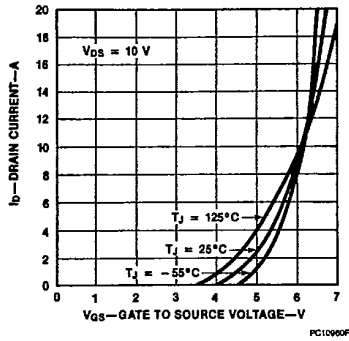

Figure 4 Temperature Variation of Gate to Source Threshold Voltage

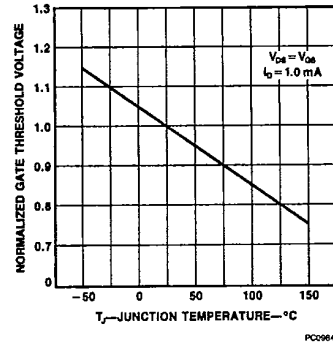

Figure 5 Capacitance vs Drain to Source Voltage

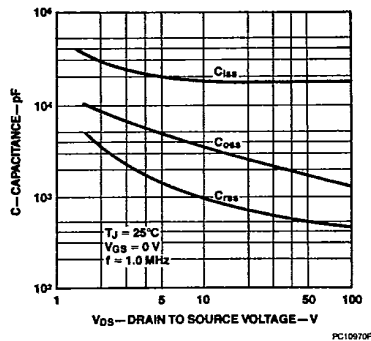

Figure 6 Gate to Source Voltage vs Total Gate Charge

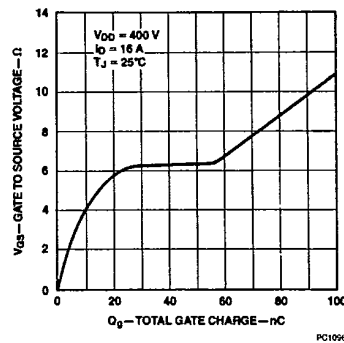

Figure 7 Forward Biased Safe Operating Area

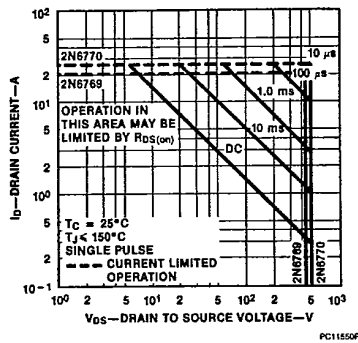
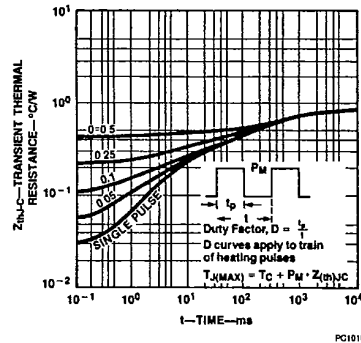

Figure 8 Transient Thermal Resistance vs Time



Typical Electrical Characteristics

Figure 9 Switching Test Circuit

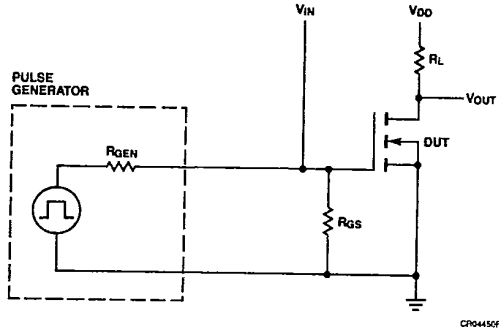
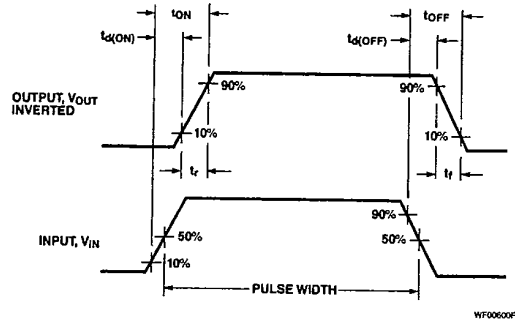

Figure 10 Switching Waveforms



Copyright © Each Manufacturing Company.

All Datasheets cannot be modified without permission.

This datasheet has been download from :

[www.AllDataSheet.com](http://www.AllDataSheet.com)

100% Free DataSheet Search Site.

Free Download.

No Register.

Fast Search System.

[www.AllDataSheet.com](http://www.AllDataSheet.com)