



STP3NC50

N-CHANNEL 500V - 3Ω - 2.8A TO-220

PowerMesh™II MOSFET

TYPE	V _{DSS}	R _{DS(on)}	I _D
STP3NC50	500 V	< 4 Ω	2.8 A

- TYPICAL R_{DS(on)} = 3 Ω
- EXTREMELY HIGH dv/dt CAPABILITY
- 100% AVALANCHE TESTED
- NEW HIGH VOLTAGE BENCHMARK
- GATE CHARGE MINIMIZED

DESCRIPTION

The PowerMESH™II is the evolution of the first generation of MESH OVERLAY™. The layout refinements introduced greatly improve the Ron*area figure of merit while keeping the device at the leading edge for what concerns switching speed, gate charge and ruggedness.

APPLICATIONS

- HIGH CURRENT, HIGH SPEED SWITCHING
- SWITCH MODE POWER SUPPLIES (SMPS)
- DC-AC CONVERTERS FOR WELDING EQUIPMENT AND UNINTERRUPTIBLE POWER SUPPLIES AND MOTOR DRIVER

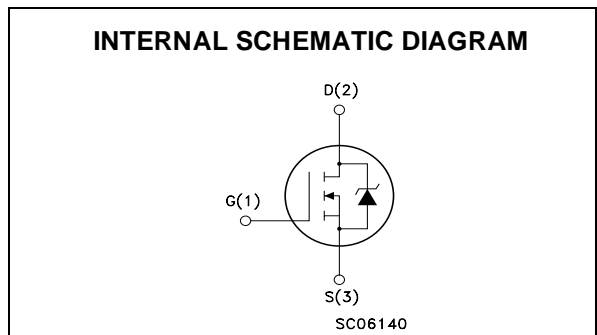
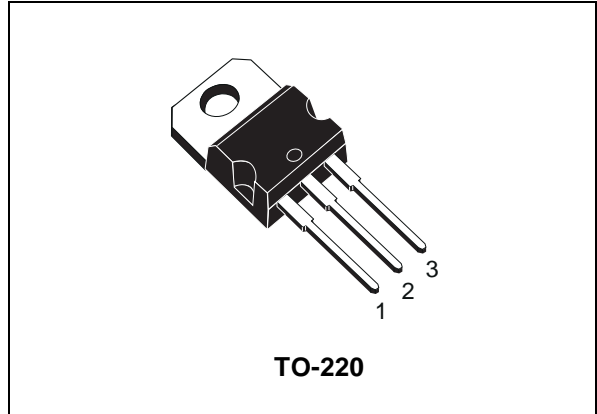

ABSOLUTE MAXIMUM RATINGS

Symbol	Parameter	Value	Unit
V _{DS}	Drain-source Voltage (V _{GS} = 0)	500	V
V _{DGR}	Drain-gate Voltage (R _{GS} = 20 kΩ)	500	V
V _{GS}	Gate- source Voltage	±30	V
I _D	Drain Current (continuous) at T _C = 25°C	2.8	A
I _D	Drain Current (continuous) at T _C = 100°C	1.8	A
I _{DM} (1)	Drain Current (pulsed)	11.2	A
P _{TOT}	Total Dissipation at T _C = 25°C	75	W
	Derating Factor	0.6	W/°C
dv/dt	Peak Diode Recovery voltage slope	3	V/ns
T _{stg}	Storage Temperature	-60 to 150	°C
T _j	Max. Operating Junction Temperature	150	°C

(*)Pulse width limited by safe operating area

(1)I_{SD} ≤ 2.8A, di/dt ≤ 100A/μs, V_{DD} ≤ V_{(BR)DSS}, T_j ≤ T_{JMAX}

STP3NC50

THERMAL DATA

Rthj-case	Thermal Resistance Junction-case Max	1.67	°C/W
Rthj-amb	Thermal Resistance Junction-ambient Max	62.5	°C/W
T _I	Maximum Lead Temperature For Soldering Purpose	300	°C

AVALANCHE CHARACTERISTICS

Symbol	Parameter	Max Value	Unit
I _{AR}	Avalanche Current, Repetitive or Not-Repetitive (pulse width limited by T _j max)	2.8	A
E _{AS}	Single Pulse Avalanche Energy (starting T _j = 25 °C, I _D = I _{AR} , V _{DD} = 50 V)	110	mJ

ELECTRICAL CHARACTERISTICS (TCASE = 25 °C UNLESS OTHERWISE SPECIFIED)

OFF

Symbol	Parameter	Test Conditions	Min.	Typ.	Max.	Unit
V _{(BR)DSS}	Drain-source Breakdown Voltage	I _D = 250 μA, V _{GS} = 0	500			V
I _{DSS}	Zero Gate Voltage Drain Current (V _{GS} = 0)	V _{DS} = Max Rating V _{DS} = Max Rating, T _C = 125 °C			1 50	μA μA
I _{GSS}	Gate-body Leakage Current (V _{DS} = 0)	V _{GS} = ±30V			±100	nA

ON (1)

Symbol	Parameter	Test Conditions	Min.	Typ.	Max.	Unit
V _{GS(th)}	Gate Threshold Voltage	V _{DS} = V _{GS} , I _D = 250μA	2	3	4	V
R _{DS(on)}	Static Drain-source On Resistance	V _{GS} = 10V, I _D = 1.4 A		3	4	Ω

DYNAMIC

Symbol	Parameter	Test Conditions	Min.	Typ.	Max.	Unit
g _{fs} (1)	Forward Transconductance	V _{DS} > I _{D(on)} × R _{DS(on)max} , I _D = 1.4A		2		S
C _{iss}	Input Capacitance	V _{DS} = 25V, f = 1 MHz, V _{GS} = 0		260		pF
C _{OSS}	Output Capacitance			45		pF
C _{rss}	Reverse Transfer Capacitance			5		pF

ELECTRICAL CHARACTERISTICS (CONTINUED)

SWITCHING ON

Symbol	Parameter	Test Conditions	Min.	Typ.	Max.	Unit
$t_{d(on)}$ t_r	Turn-on Delay Time Rise Time	$V_{DD} = 250V, I_D = 1.4 A$ $R_G = 4.7\Omega, V_{GS} = 10V$ (see test circuit, Figure 3)		10 10		ns ns
Q_g Q_{gs} Q_{gd}	Total Gate Charge Gate-Source Charge Gate-Drain Charge	$V_{DD} = 400V, I_D = 2.8 A,$ $V_{GS} = 10V$		10 2.5 4.5	13.5	nC nC nC

SWITCHING OFF

Symbol	Parameter	Test Conditions	Min.	Typ.	Max.	Unit
$t_{r(Voff)}$ t_f t_c	Off-voltage Rise Time Fall Time Cross-over Time	$V_{DD} = 400V, I_D = 2.8 A,$ $R_G = 4.7\Omega, V_{GS} = 10V$ (see test circuit, Figure 5)		10 8 20		ns ns ns

SOURCE DRAIN DIODE

Symbol	Parameter	Test Conditions	Min.	Typ.	Max.	Unit
I_{SD}	Source-drain Current				2.8	A
$I_{SDM(2)}$	Source-drain Current (pulsed)				11.2	A
$V_{SD(1)}$	Forward On Voltage	$I_{SD} = 2.8 A, V_{GS} = 0$			1.6	V
t_{rr} Q_{rr} I_{RRM}	Reverse Recovery Time Reverse Recovery Charge Reverse Recovery Current	$I_{SD} = 2.8A, di/dt = 100A/\mu s,$ $V_{DD} = 100V, T_j = 150^\circ C$ (see test circuit, Figure 5)		380 2200 11.5		ns nC A

Note: 1. Pulsed: Pulse duration = 300 μs , duty cycle 1.5 %.
2. Pulse width limited by safe operating area.

Safe Operating Area

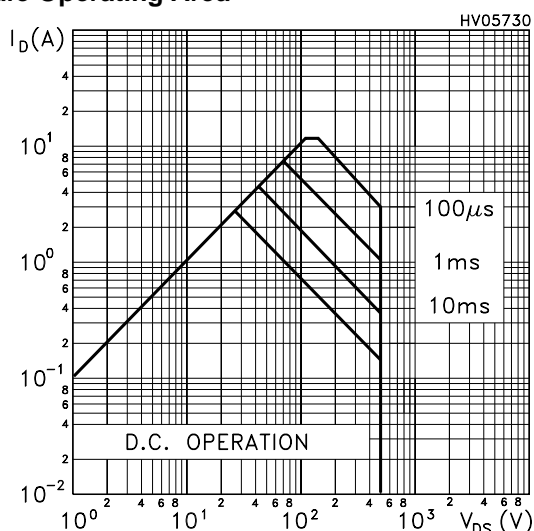

Thermal Impedence

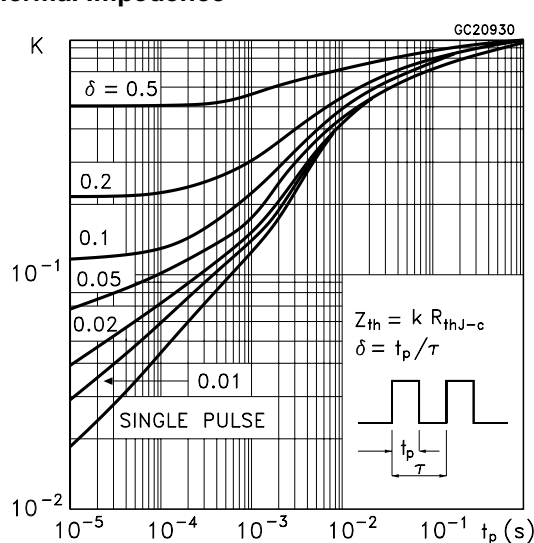

Output Characteristics

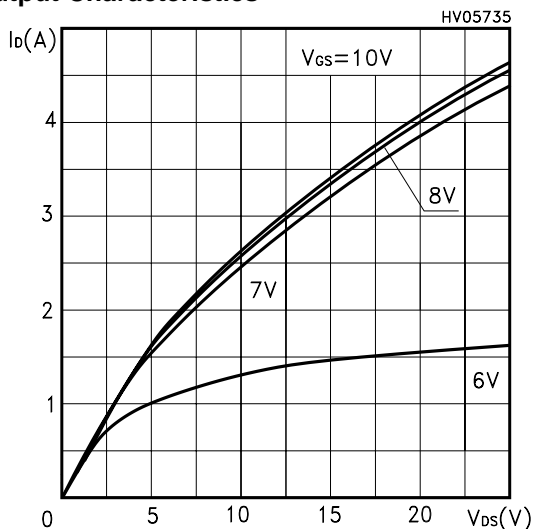

Transfer Characteristics

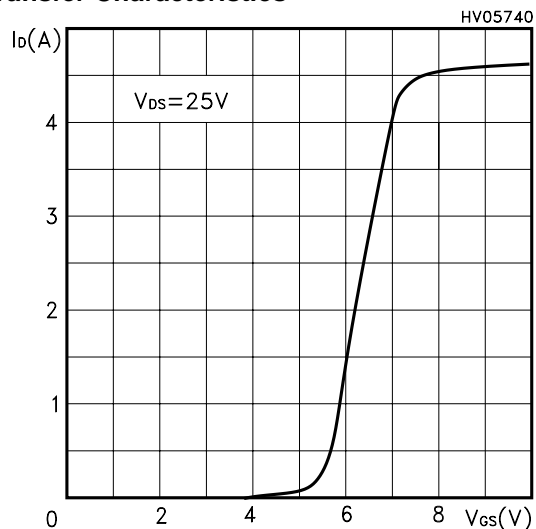

Transconductance

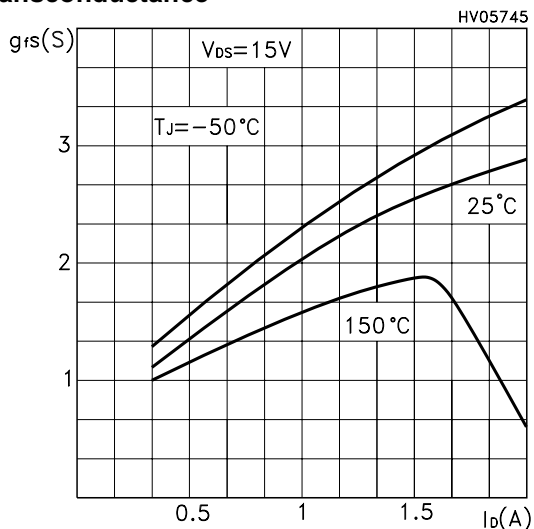

Static Drain-source On Resistance

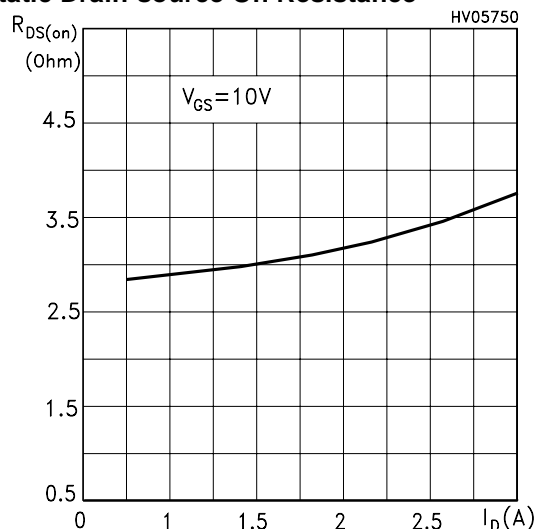

Gate Charge vs Gate-source Voltage

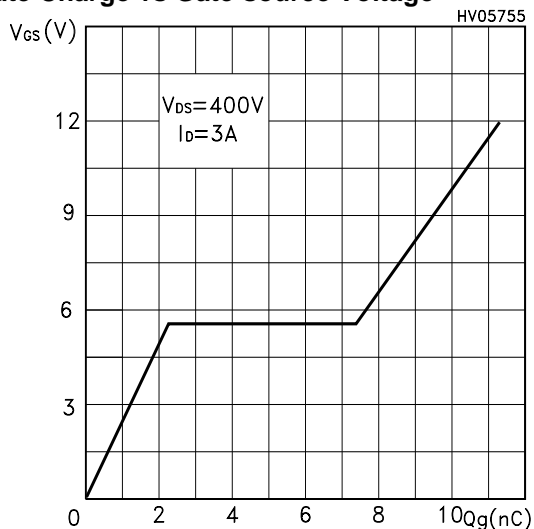

Capacitance Variations

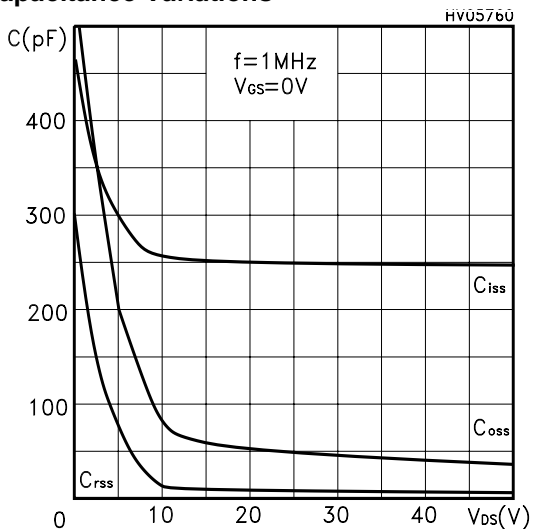

Normalized Gate Threshold Voltage vs Temperature

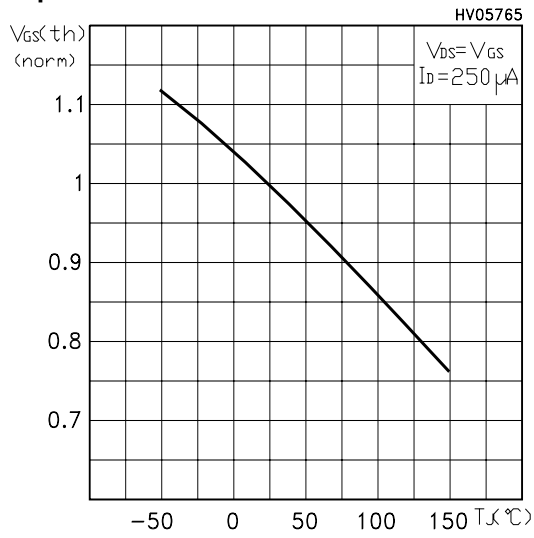

Normalized On Resistance vs Temperature

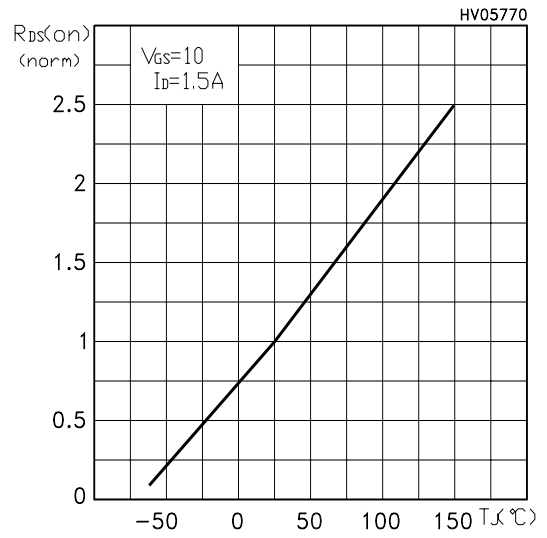

Source-drain Diode Forward Characteristics

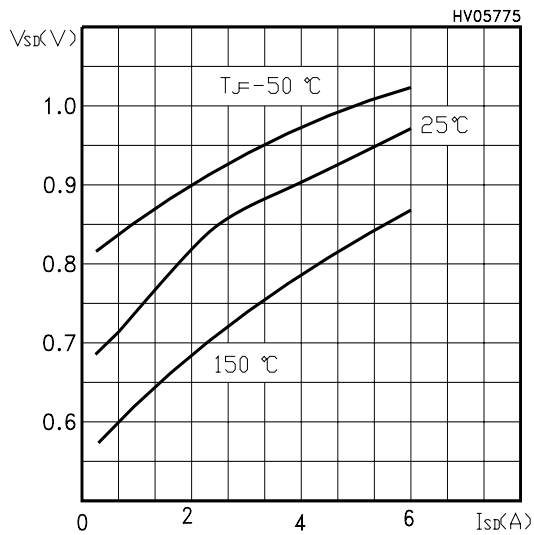

Fig. 1: Unclamped Inductive Load Test Circuit



Fig. 2: Unclamped Inductive Waveform



Fig. 3: Switching Times Test Circuit For Resistive Load



Fig. 4: Gate Charge test Circuit

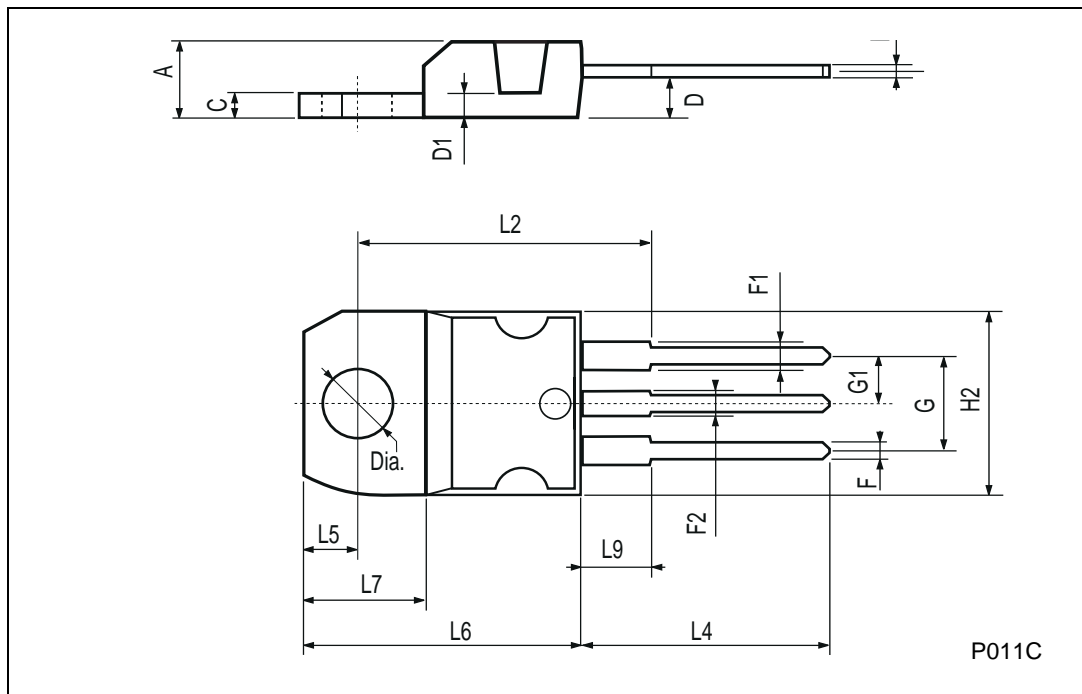

Fig. 5: Test Circuit For Inductive Load Switching And Diode Recovery Times



TO-220 MECHANICAL DATA

DIM.	mm			inch		
	MIN.	TYP.	MAX.	MIN.	TYP.	MAX.
A	4.40		4.60	0.173		0.181
C	1.23		1.32	0.048		0.051
D	2.40		2.72	0.094		0.107
D1		1.27			0.050	
E	0.49		0.70	0.019		0.027
F	0.61		0.88	0.024		0.034
F1	1.14		1.70	0.044		0.067
F2	1.14		1.70	0.044		0.067
G	4.95		5.15	0.194		0.203
G1	2.4		2.7	0.094		0.106
H2	10.0		10.40	0.393		0.409
L2		16.4			0.645	
L4	13.0		14.0	0.511		0.551
L5	2.65		2.95	0.104		0.116
L6	15.25		15.75	0.600		0.620
L7	6.2		6.6	0.244		0.260
L9	3.5		3.93	0.137		0.154
DIA.	3.75		3.85	0.147		0.151



Information furnished is believed to be accurate and reliable. However, STMicroelectronics assumes no responsibility for the consequences of use of such information nor for any infringement of patents or other rights of third parties which may result from its use. No license is granted by implication or otherwise under any patent or patent rights of STMicroelectronics. Specification mentioned in this publication are subject to change without notice. This publication supersedes and replaces all information previously supplied. STMicroelectronics products are not authorized for use as critical components in life support devices or systems without express written approval of STMicroelectronics.

The ST logo is a trademark of STMicroelectronics

© 2001 STMicroelectronics – Printed in Italy – All Rights Reserved
STMicroelectronics GROUP OF COMPANIES

Australia - Brazil - China - Finland - France - Germany - Hong Kong - India - Italy - Japan - Malaysia - Malta - Morocco -
Singapore - Spain - Sweden - Switzerland - United Kingdom - U.S.A.

<http://www.st.com>

Copyright © Each Manufacturing Company.

All Datasheets cannot be modified without permission.

This datasheet has been download from :

www.AllDataSheet.com

100% Free DataSheet Search Site.

Free Download.

No Register.

Fast Search System.

www.AllDataSheet.com