



May 1996

NDP7061 / NDB7061 N-Channel Enhancement Mode Field Effect Transistor

General Description

These N-Channel enhancement mode power field effect transistors are produced using Fairchild's proprietary, high cell density, DMOS technology. This very high density process is especially tailored to minimize on-state resistance, provide superior switching performance, and withstand high energy pulses in the avalanche and commutation modes. These devices are particularly suited for low voltage applications such as automotive, DC/DC converters, PWM motor controls, and other battery powered circuits where fast switching, low in-line power loss, and resistance to transients are needed.

Features

- 64A, 60V. $R_{DS(ON)} = 0.016\Omega @ V_{GS}=10V$.
- Critical DC electrical parameters specified at elevated temperature.
- Rugged internal source-drain diode can eliminate the need for an external Zener diode transient suppressor.
- 175°C maximum junction temperature rating.
- High density cell design for extremely low $R_{DS(ON)}$.
- TO-220 and TO-263 (D²PAK) package for both through hole and surface mount applications.

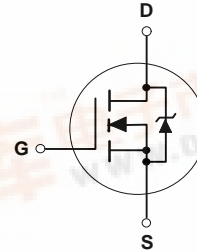
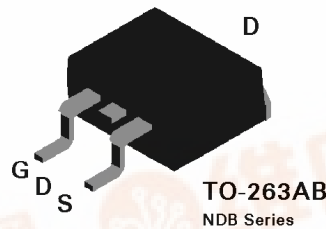
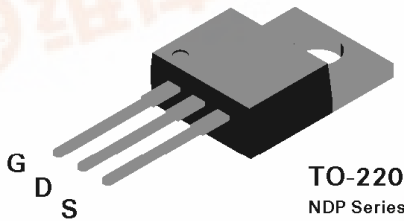

Absolute Maximum Ratings T_c = 25°C unless otherwise noted

| Symbol | Parameter | NDP7061 | NDB7061 | Units |
|-----------------------------------|--|------------|---------|-------|
| V _{DSS} | Drain-Source Voltage | 60 | | V |
| V _{DGR} | Drain-Gate Voltage (R _{GS} ≤ 1 MΩ) | 60 | | V |
| V _{GSS} | Gate-Source Voltage - Continuous | ± 20 | | V |
| | - Nonrepetitive (t _p < 50 μs) | ± 40 | | |
| I _D | Drain Current - Continuous | 64 | | A |
| | - Pulsed | 190 | | |
| P _D | Maximum Power Dissipation @ T _c = 25°C Derate above 25°C | 130 | | W |
| | | 0.87 | | |
| T _J , T _{STG} | Operating and Storage Temperature Range | -65 to 175 | | °C |
| T _L | Maximum lead temperature for soldering purposes, 1/8" from case for 5 seconds | 275 | | °C |

Electrical Characteristics ($T_c = 25^\circ\text{C}$ unless otherwise noted)

| Symbol | Parameter | Conditions | Min | Typ | Max | Units |
|-----------|--|---|-----|-----|-----|-------|
| W_{DSS} | Single Pulse Drain-Source Avalanche Energy | $V_{DD} = 30\text{ V}, I_D = 64\text{ A}$ | | | 500 | mJ |
| I_{AR} | Maximum Drain-Source Avalanche Current | | | | 64 | A |

OFF CHARACTERISTICS

| | | | | | | |
|------------|---------------------------------|---|----|--|------|---------------|
| BV_{DSS} | Drain-Source Breakdown Voltage | $V_{GS} = 0\text{ V}, I_D = 250\ \mu\text{A}$ | 60 | | | V |
| I_{DSS} | Zero Gate Voltage Drain Current | $V_{DS} = 48\text{ V}, V_{GS} = 0\text{ V}$ | | | 10 | μA |
| | | $T_J = 125^\circ\text{C}$ | | | 1 | mA |
| I_{GSSF} | Gate - Body Leakage, Forward | $V_{GS} = 20\text{ V}, V_{DS} = 0\text{ V}$ | | | 100 | nA |
| I_{GSSR} | Gate - Body Leakage, Reverse | $V_{GS} = -20\text{ V}, V_{DS} = 0\text{ V}$ | | | -100 | nA |

ON CHARACTERISTICS (Note 1)

| | | | | | | |
|--------------|-----------------------------------|--|-----|-------|-------|----------|
| $V_{GS(th)}$ | Gate Threshold Voltage | $V_{DS} = V_{GS}, I_D = 250\ \mu\text{A}$ | 2 | 2.9 | 4 | V |
| | | $T_J = 125^\circ\text{C}$ | 1.4 | 2.2 | 3.6 | |
| $R_{DS(on)}$ | Static Drain-Source On-Resistance | $V_{GS} = 10\text{ V}, I_D = 35\text{ A}$ | | 0.013 | 0.016 | Ω |
| | | $T_J = 125^\circ\text{C}$ | | 0.021 | 0.032 | |
| $I_{D(on)}$ | On-State Drain Current | $V_{GS} = 10\text{ V}, V_{DS} = 10\text{ V}$ | 60 | | | A |
| g_{FS} | Forward Transconductance | $V_{DS} = 10\text{ V}, I_D = 35\text{ A}$ | | 30 | | S |

DYNAMIC CHARACTERISTICS

| | | | | | | |
|-----------|------------------------------|--|--|------|--|----|
| C_{iss} | Input Capacitance | $V_{DS} = 25\text{ V}, V_{GS} = 0\text{ V},$ $f = 1.0\text{ MHz}$ | | 1930 | | pF |
| C_{oss} | Output Capacitance | | | 870 | | pF |
| C_{rss} | Reverse Transfer Capacitance | | | 310 | | pF |

SWITCHING CHARACTERISTICS (Note 1)

| | | | | | | |
|--------------|-----------------------|---|--|------|-----|----|
| $t_{D(on)}$ | Turn - On Delay Time | $V_{DD} = 25\text{ V}, I_D = 64\text{ A},$ $V_{GS} = 10\text{ V}, R_{GEN} = 5\ \Omega$ | | 13 | 30 | nS |
| t_r | Turn - On Rise Time | | | 98 | 200 | nS |
| $t_{D(off)}$ | Turn - Off Delay Time | | | 36 | 80 | nS |
| t_f | Turn - Off Fall Time | | | 65 | 150 | nS |
| Q_g | Total Gate Charge | | | 67 | 100 | nC |
| Q_{gs} | Gate-Source Charge | $V_{DS} = 48\text{ V},$ $I_D = 64\text{ A}, V_{GS} = 10\text{ V}$ | | 11 | | nC |
| Q_{gd} | Gate-Drain Charge | | | 37.5 | | nC |

Electrical Characteristics ($T_c = 25^\circ\text{C}$ unless otherwise noted)

| Symbol | Parameter | Conditions | Min | Typ | Max | Units |
|---|---|--|---------------------------|-----|------|---------------------------|
| DRAIN-SOURCE DIODE CHARACTERISTICS | | | | | | |
| I_S | Maximum Continuous Drain-Source Diode Forward Current | | | | 64 | A |
| I_{SM} | Maximum Pulsed Drain-Source Diode Forward Current | | | | 190 | A |
| V_{SD} | Drain-Source Diode Forward Voltage | $V_{GS} = 0\text{ V}, I_S = 35\text{ A}$ (Note 1) | | 0.9 | 1.3 | V |
| | | | $T_J = 125^\circ\text{C}$ | 0.8 | 1.2 | |
| t_{rr} | Reverse Recovery Time | $V_{GS} = 0\text{ V}, I_F = 64\text{ A}, di_F/dt = 100\text{ A}/\mu\text{s}$ | 40 | 105 | 150 | ns |
| I_{rr} | Reverse Recovery Current | | 2 | 4.5 | 10 | A |
| THERMAL CHARACTERISTICS | | | | | | |
| $R_{\theta JC}$ | Thermal Resistance, Junction-to-Case | | | | 1.15 | $^\circ\text{C}/\text{W}$ |
| $R_{\theta JA}$ | Thermal Resistance, Junction-to-Ambient | | | | 62.5 | $^\circ\text{C}/\text{W}$ |

Note:

1. Pulse Test: Pulse Width $\leq 300\ \mu\text{s}$, Duty Cycle $\leq 2.0\%$.

Typical Electrical Characteristics

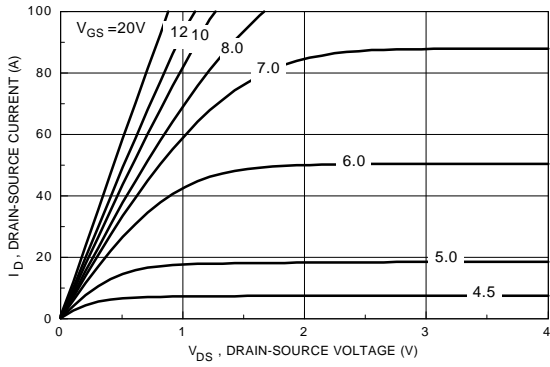

Figure 1. On-Region Characteristics

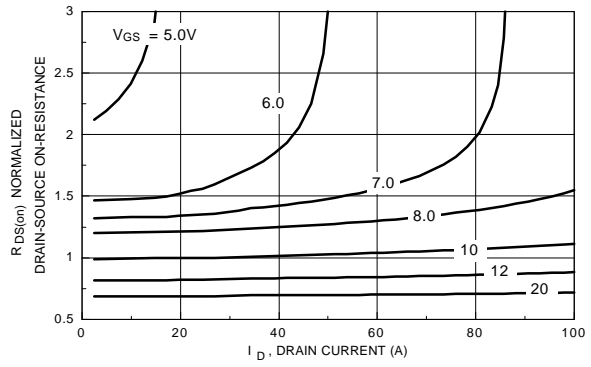

Figure 2. On-Resistance Variation with Gate Voltage and Drain Current

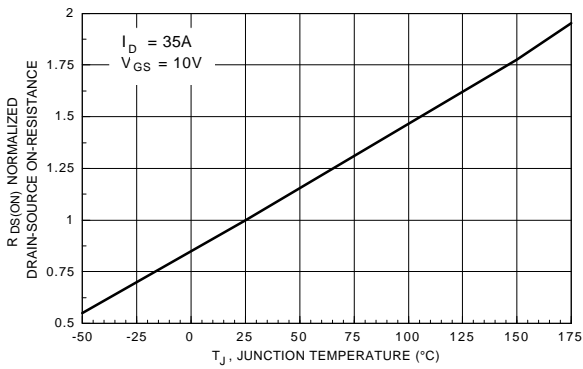

Figure 3. On-Resistance Variation with Temperature

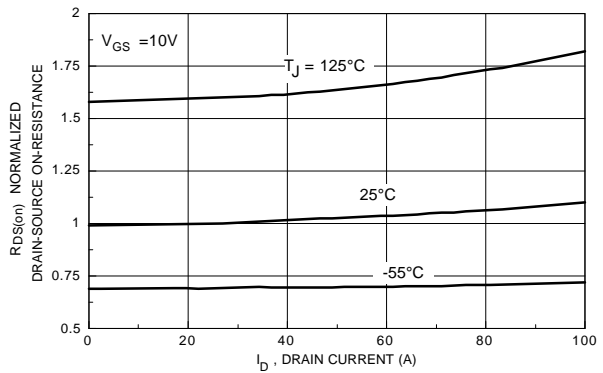

Figure 4. On-Resistance Variation with Drain Current and Temperature

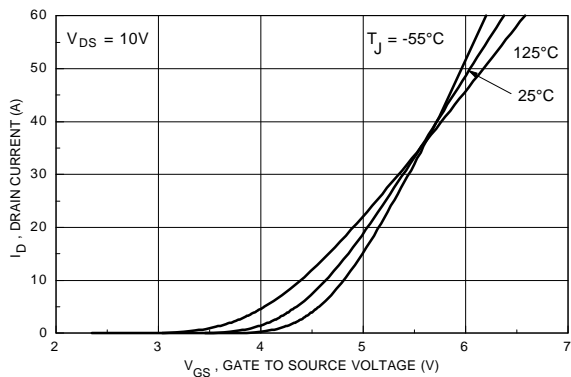

Figure 5. Transfer Characteristics

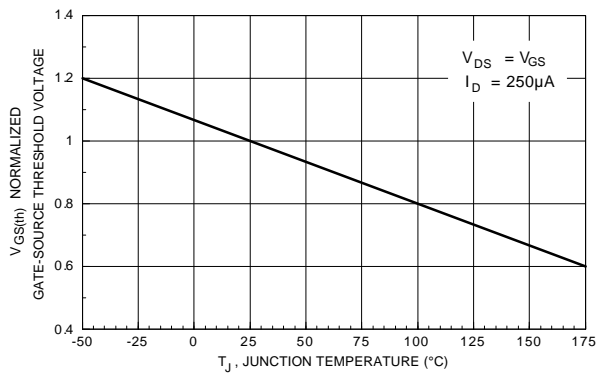

Figure 6. Gate Threshold Variation with Temperature

Typical Electrical Characteristics (continued)

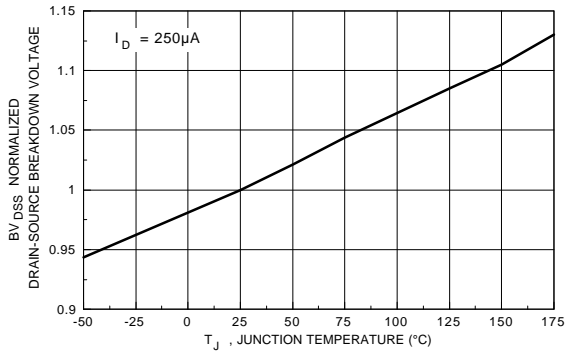

Figure 7. Breakdown Voltage Variation with Temperature

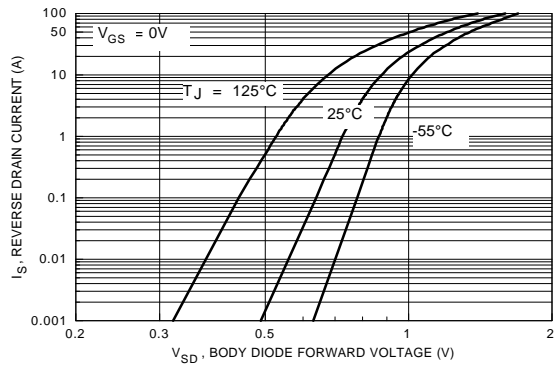

Figure 8. Body Diode Forward Voltage Variation with Current and Temperature

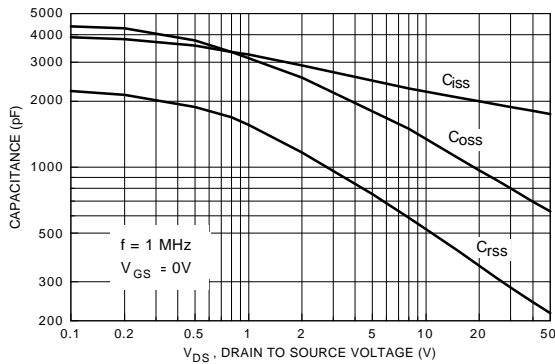

Figure 9. Capacitance Characteristics

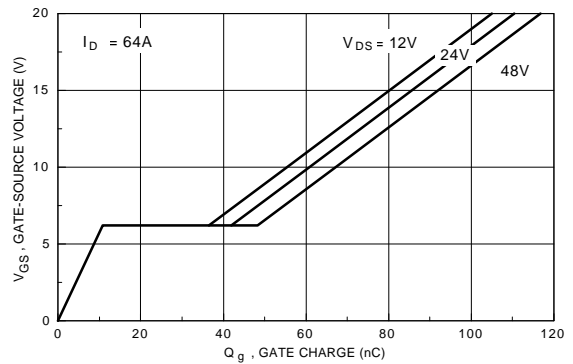

Figure 10. Gate Charge Characteristics

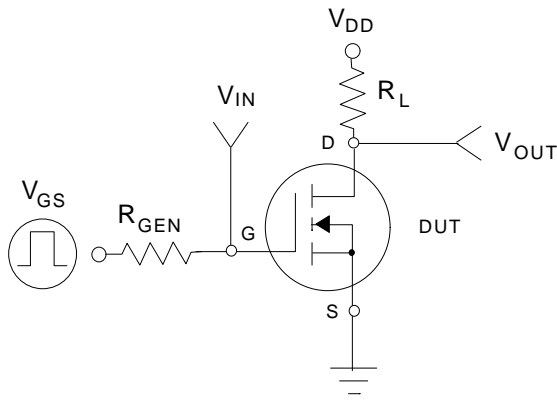

Figure 11. Switching Test Circuit

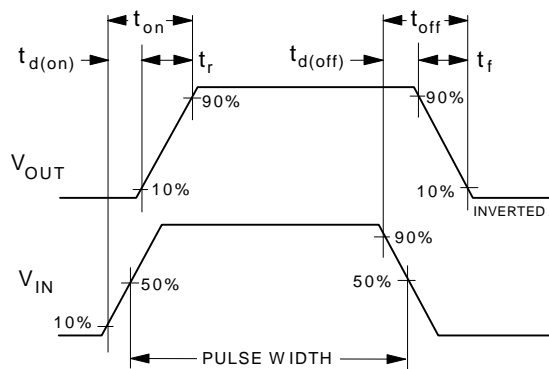

Figure 12. Switching Waveforms

Typical Electrical Characteristics (continued)

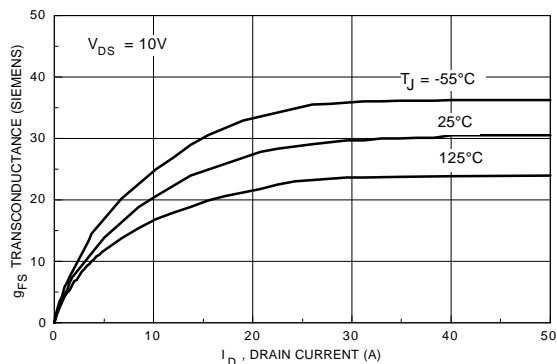

Figure 13. Transconductance Variation with Drain Current and Temperature

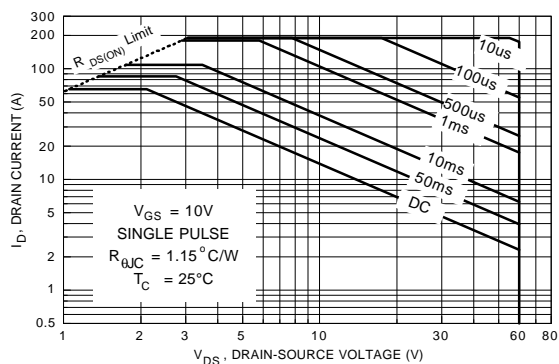

Figure 14. Maximum Safe Operating Area

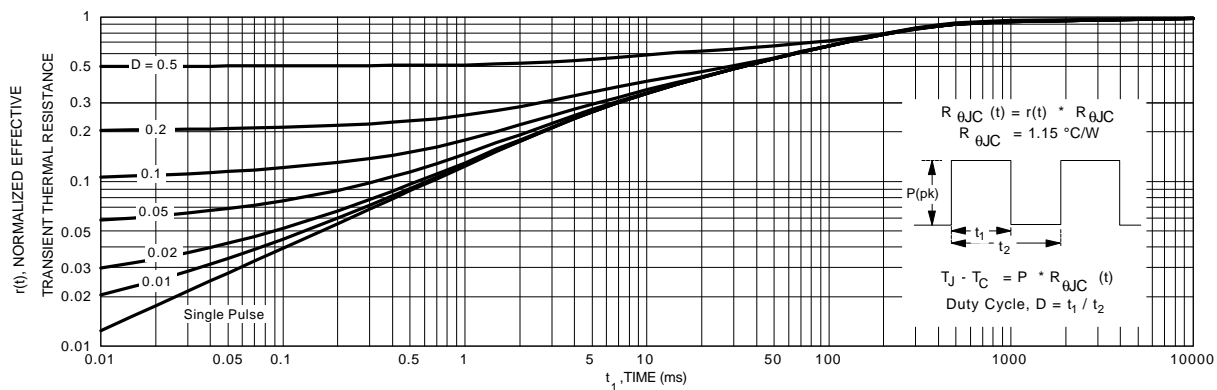
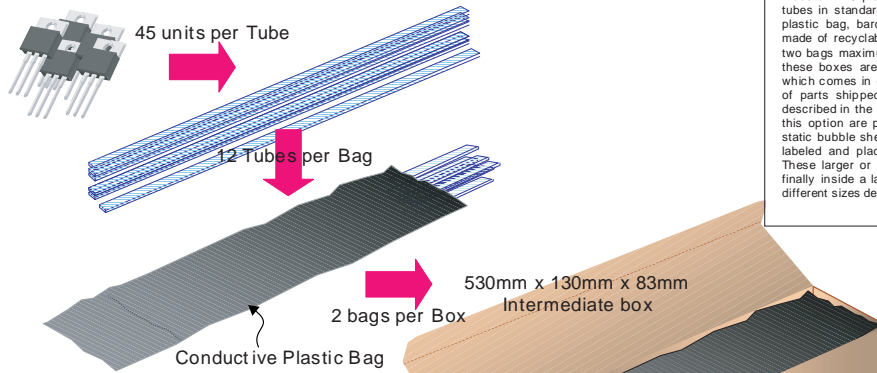

Figure 15. Transient Thermal Response Curve

TO-220 Tape and Reel Data and Package Dimensions



TO-220 Tube Packing Configuration: Figure 1.0



Packaging Description:

TO-220 parts are shipped normally in tube. The tube is made of PVC plastic treated with anti-static agent. These tubes in standard option are placed inside a dissipative plastic bag, barcode labeled, and placed inside a box made of recyclable corrugated paper. One box contains two bags maximum (see fig. 1.0). And one or several of these boxes are placed inside a labeled shipping box which comes in different sizes depending on the number of parts shipped. The other option comes in bulk as described in the Packaging information table. The units in this option are placed inside a small box laid with anti-static bubble sheet. These smaller boxes are individually labeled and placed inside a larger box (see fig. 3.0). These larger or intermediate boxes then will be placed finally inside a labeled shipping box which still comes in different sizes depending on the number of units shipped.

TO-220 Packaging Information: Figure 2.0

| TO-220 Packaging Information | | |
|------------------------------|-------------------------|------------|
| Packaging Option | Standard (no flow code) | S62Z |
| Packaging type | Rail/Tube | BULK |
| Qty per Tube/Box | 45 | 300 |
| Box Dimension (mm) | 530x130x83 | 114x102x51 |
| Max qty per Box | 1,080 | 1,500 |
| Weight per unit (gm) | 1.4378 | 1.4378 |
| Note/Comments | | |

FSCINT Label sample



TO-220 bulk Packing Configuration: Figure 3.0

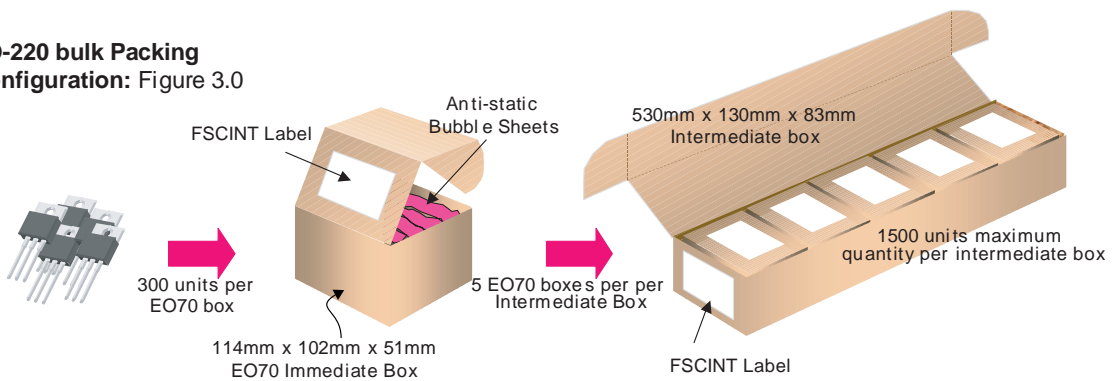

TO-220 Tube Configuration: Figure 4.0

Note: All dimensions are in inches

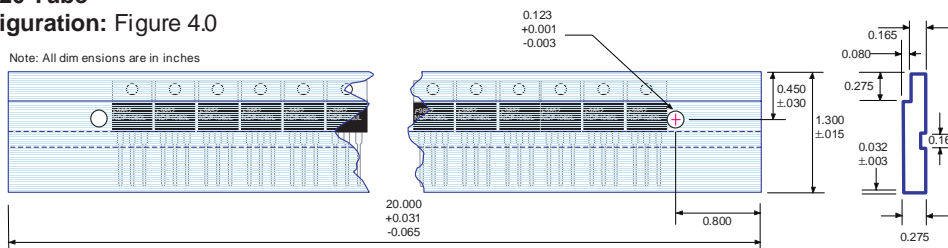

TO-220 Tape and Reel Data and Package Dimensions, continued

TO-220 (FS PKG Code 37)

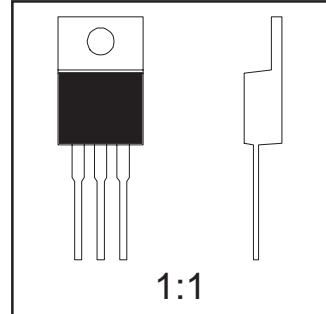
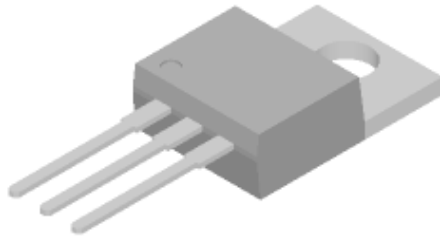

Scale 1:1 on letter size paper

Dimensions shown below are in:
inches [millimeters]

Part Weight per unit (gram): 1.4378

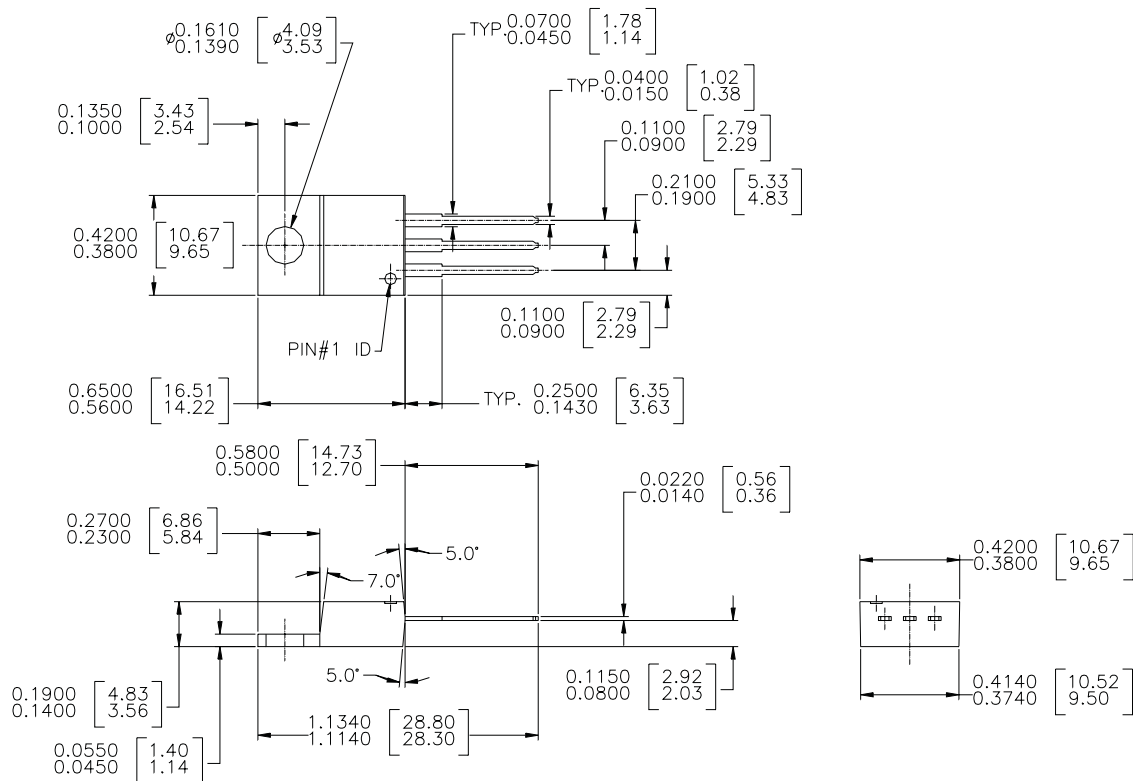

NOTE : UNLESS OTHERWISE SPECIFIED

1. STANDARD LEAD FINISH :
200 MICRONS / 5.08 MICRON MINIMUM
LEAD / TIN 15/85 ON OLIN 194 COPPER OR EQUIVALENT

2. DIMENSION BASED ON JEDEC STANDARD TO-220
VARIATION AB, ISSUE J, DATED 3/24/87

TO 220 3 LEAD

TO-263AB/D²PAK Tape and Reel Data and Package Dimensions



TO-263AB/D²PAK Packaging Configuration: Figure 1.0

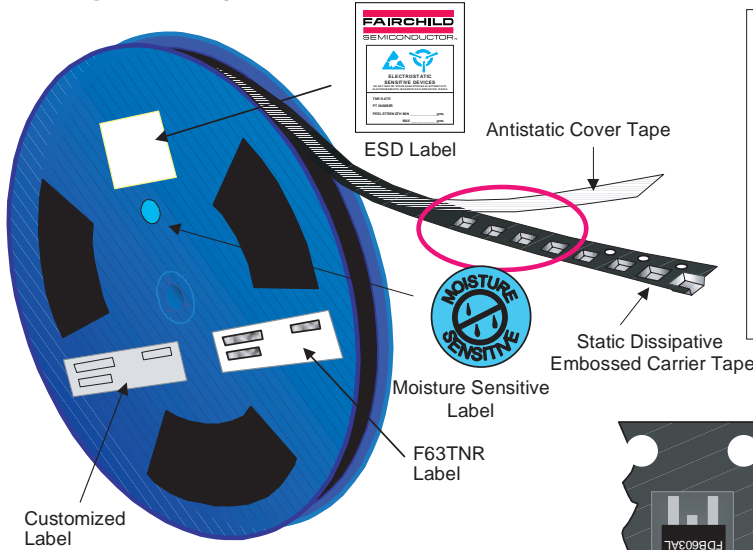

Packaging Description:

TO-263/D²PAK parts are shipped in tape. The carrier tape is made from a dissipative (carbon filled) polycarbonate resin. The cover tape is a multilayer film (Heat Activated Adhesive in nature) primarily composed of polyester film, adhesive layer, sealer, and anti-static sprayed agent. These reeled parts in standard option are shipped with 800 units per 13' or 330cm diameter reel. The reels are dark blue in color and is made of polystyrene plastic (anti-static coated). This and some other options are further described in the Packaging Information table.

These full reels are individually barcode labeled, dry packed, and placed inside a standard intermediate box (illustrated in figure 1.0) made of recyclable corrugated brown paper. One box contains one reel maximum. And these boxes are placed inside a barcode labeled shipping box which comes in different sizes depending on the number of parts shipped.

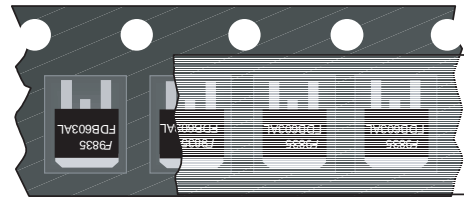

TO-263AB/D²PAK Unit Orientation

| TO-263AB/D ² PAK Packaging Information | | |
|---|-------------------------|------------|
| Packaging Option | Standard (no flow code) | L86Z |
| Packaging type | TNR | Rail/Tube |
| Qty per Reel/Tube/Bag | 800 | 45 |
| Reel Size | 13" Dia | - |
| Box Dimension (mm) | 359x359x57 | 530x130x83 |
| Max qty per Box | 800 | 1,080 |
| Weight per unit (gm) | 1.4378 | 1.4378 |
| Weight per Reel | 1.6050 | - |
| Note/Comments | | |

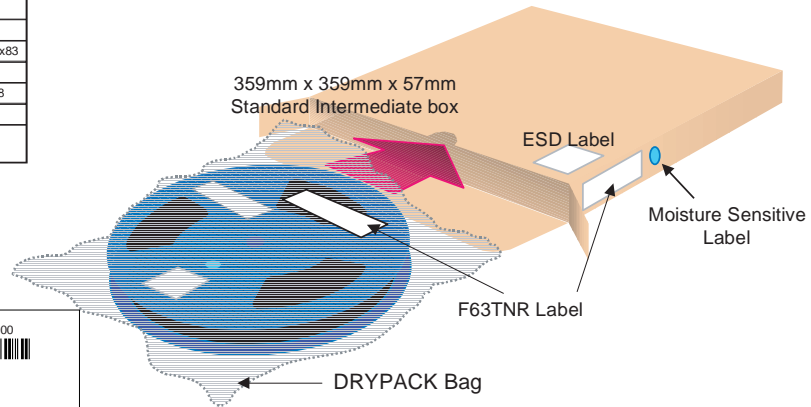

F63TNR Label sample



TO-263AB/D²PAK Tape Leader and Trailer Configuration: Figure 2.0

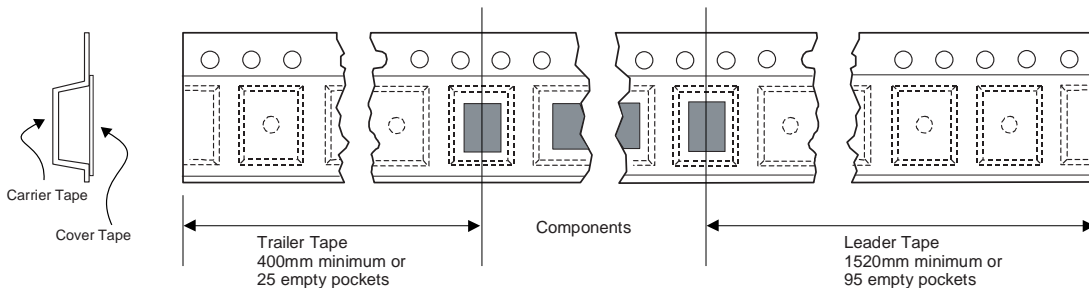

TO-263AB/D²PAK Tape and Reel Data and Package Dimensions, continued

TO-263AB/D²PAK Embossed Carrier Tape

Configuration: Figure 3.0

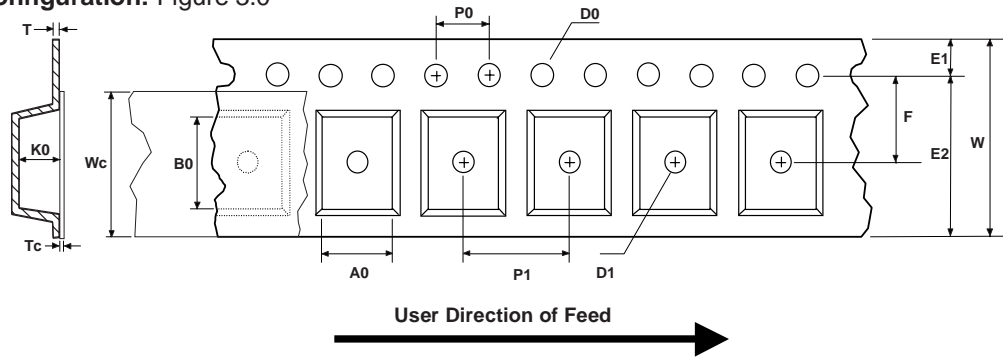

| Dimensions are in millimeter | | | | | | | | | | | | | | |
|--|------------------|------------------|----------------|-----------------|-----------------|-----------------|--------------|------------------|----------------|---------------|-----------------|-------------------|----------------|-----------------|
| Pkg type | A0 | B0 | W | D0 | D1 | E1 | E2 | F | P1 | P0 | K0 | T | Wc | Tc |
| TO263AB/ D ² PAK (24mm) | 10.60 +/-0.10 | 15.80 +/-0.10 | 24.0 +/-0.3 | 1.55 +/-0.05 | 1.60 +/-0.10 | 1.75 +/-0.10 | 22.25 min | 11.50 +/-0.10 | 16.0 +/-0.1 | 4.0 +/-0.1 | 4.90 +/-0.10 | 0.450 +/-0.150 | 21.0 +/-0.3 | 0.06 +/-0.02 |

Notes: A0, B0, and K0 dimensions are determined with respect to the EIA/Jedec RS-481 rotational and lateral movement requirements (see sketches A, B, and C).

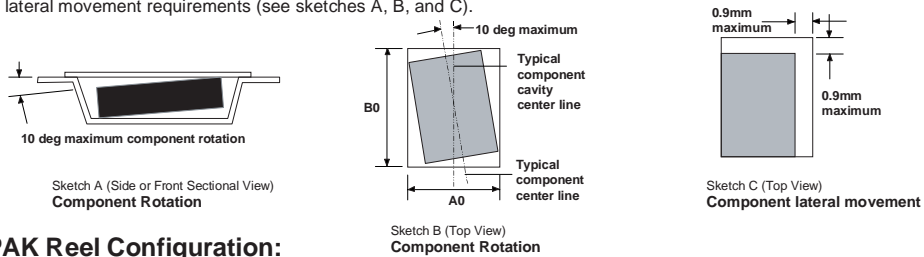

TO-263AB/D²PAK Reel Configuration: Figure 4.0

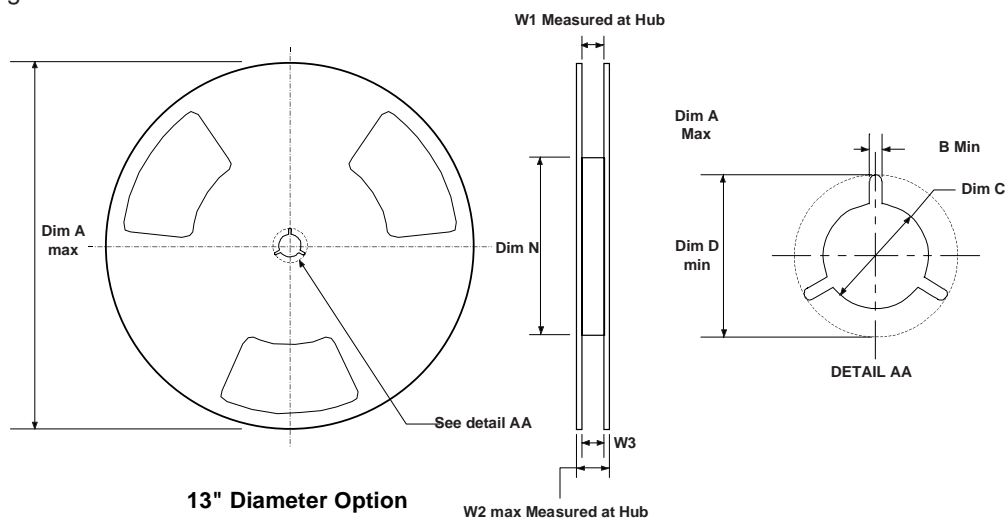

| Dimensions are in inches and millimeters | | | | | | | | | |
|--|-------------|--------------|--------------|-----------------------------------|---------------|-------------|----------------------------------|---------------|--------------------------------|
| Tape Size | Reel Option | Dim A | Dim B | Dim C | Dim D | Dim N | Dim W1 | Dim W2 | Dim W3 (LSL-USL) |
| 24mm | 13" Dia | 13.00 330 | 0.059 1.5 | 512 +0.020/-0.008 13 +0.5/-0.2 | 0.795 20.2 | 4.00 100 | 0.961 +0.078/-0.000 24.4 +2/0 | 1.197 30.4 | 0.941 - 0.1.079 23.9 - 27.4 |

TO-263AB/D²PAK Tape and Reel Data and Package Dimensions, continued

TO-263AB/D²PAK (FS PKG Code 45)

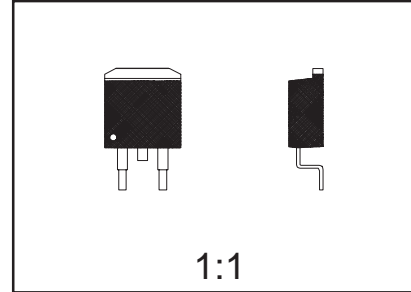
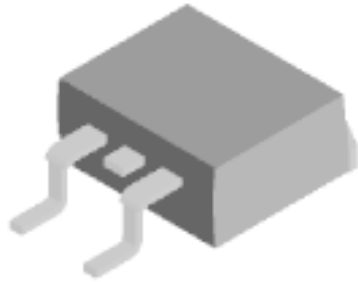

Scale 1:1 on letter size paper

Dimensions shown below are in:
inches [millimeters]

Part Weight per unit (gram): 1.4378

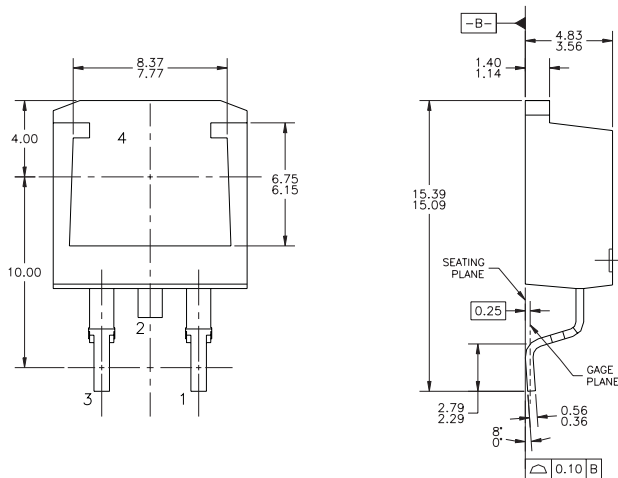
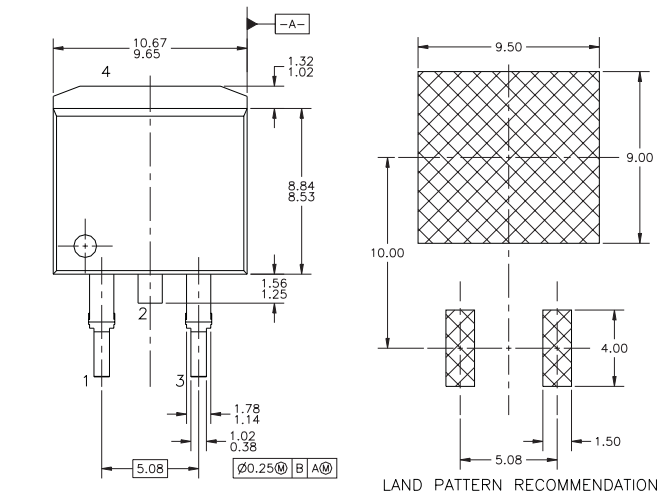

- NOTES: UNLESS OTHERWISE SPECIFIED
- ALL DIMENSIONS ARE IN MILLIMETERS.
 - STANDARD LEAD FINISH:
200 MICRONS / 5.08 MICROMETERS MIN.
LEAD/TIN 15/85 ON OLIN 194 COPPER OR EQUIVALENT.
 - MAXIMUM VERTICAL BURR ON HEATSINK NOT TO EXCEED 0.003 INCH / 0.05mm.
 - NO PACKAGE CHIPS, CRACKS OR SURFACE IDENTIFICATION ALLOWED AFTER FORMING.
 - REFERENCE JEDEC, TO-263, ISSUE C, VARIATION AB, DATED 2/92.

TRADEMARKS

The following are registered and unregistered trademarks Fairchild Semiconductor owns or is authorized to use and is not intended to be an exhaustive list of all such trademarks.

| | | |
|----------------------|---------------|------------|
| ACEx™ | ISOPLANAR™ | SyncFET™ |
| CoolFET™ | MICROWIRE™ | TinyLogic™ |
| CROSSVOLT™ | POP™ | UHC™ |
| E ² CMOS™ | PowerTrench® | VCX™ |
| FACT™ | QFET™ | |
| FACT Quiet Series™ | QS™ | |
| FAST® | Quiet Series™ | |
| FASTr™ | SuperSOT™-3 | |
| GTO™ | SuperSOT™-6 | |
| HiSeC™ | SuperSOT™-8 | |

DISCLAIMER

FAIRCHILD SEMICONDUCTOR RESERVES THE RIGHT TO MAKE CHANGES WITHOUT FURTHER NOTICE TO ANY PRODUCTS HEREIN TO IMPROVE RELIABILITY, FUNCTION OR DESIGN. FAIRCHILD DOES NOT ASSUME ANY LIABILITY ARISING OUT OF THE APPLICATION OR USE OF ANY PRODUCT OR CIRCUIT DESCRIBED HEREIN; NEITHER DOES IT CONVEY ANY LICENSE UNDER ITS PATENT RIGHTS, NOR THE RIGHTS OF OTHERS.

LIFE SUPPORT POLICY

FAIRCHILD'S PRODUCTS ARE NOT AUTHORIZED FOR USE AS CRITICAL COMPONENTS IN LIFE SUPPORT DEVICES OR SYSTEMS WITHOUT THE EXPRESS WRITTEN APPROVAL OF FAIRCHILD SEMICONDUCTOR CORPORATION. As used herein:

1. Life support devices or systems are devices or systems which, (a) are intended for surgical implant into the body, or (b) support or sustain life, or (c) whose failure to perform when properly used in accordance with instructions for use provided in the labeling, can be reasonably expected to result in significant injury to the user.
2. A critical component is any component of a life support device or system whose failure to perform can be reasonably expected to cause the failure of the life support device or system, or to affect its safety or effectiveness.

PRODUCT STATUS DEFINITIONS

Definition of Terms

| Datasheet Identification | Product Status | Definition |
|--------------------------|------------------------|---|
| Advance Information | Formative or In Design | This datasheet contains the design specifications for product development. Specifications may change in any manner without notice. |
| Preliminary | First Production | This datasheet contains preliminary data, and supplementary data will be published at a later date. Fairchild Semiconductor reserves the right to make changes at any time without notice in order to improve design. |
| No Identification Needed | Full Production | This datasheet contains final specifications. Fairchild Semiconductor reserves the right to make changes at any time without notice in order to improve design. |
| Obsolete | Not In Production | This datasheet contains specifications on a product that has been discontinued by Fairchild semiconductor. The datasheet is printed for reference information only. |