



# NEC's NPN SILICON TRANSISTOR

# NE851M13

## FEATURES

- **NEW MINIATURE M13 PACKAGE:**
  - Small transistor outline
  - 1.0 X 0.5 X 0.5 mm
  - Low profile / 0.50 mm package height
  - Flat lead style for better RF performance
- **IDEAL FOR  $\leq 3$  GHz OSCILLATORS**
- **LOW PHASE NOISE**
- **LOW PUSHING FACTOR**

## DESCRIPTION

NEC's NE851M13 transistor is designed for oscillator applications up to 3 GHz. The NE851M13 features low voltage operation, low phase noise, and high immunity to pushing effects. NEC's new low profile/flat lead style "M13" package is ideal for today's portable wireless applications.

## OUTLINE DIMENSIONS (Units in mm)

PACKAGE OUTLINE M13

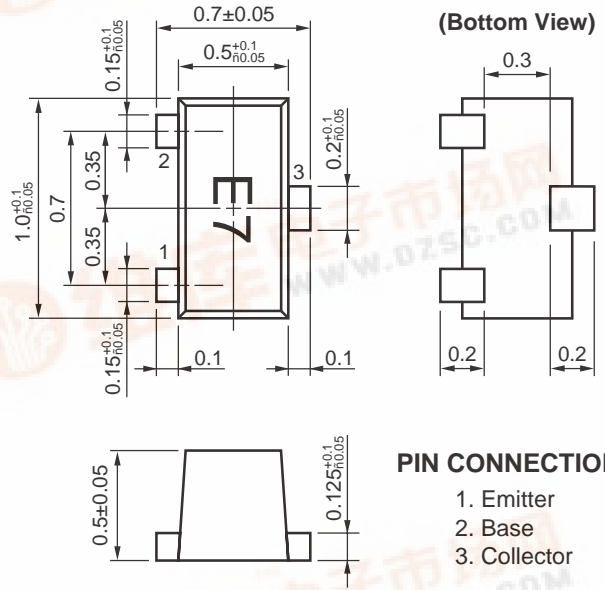

## PIN CONNECTIONS

1. Emitter
2. Base
3. Collector

## ELECTRICAL CHARACTERISTICS (TA = 25°C)

PART NUMBER EIAJ <sup>1</sup> REGISTERED NUMBER PACKAGE OUTLINE		NE851M13 2SC5801 M13			
SYMBOLS	PARAMETERS AND CONDITIONS	UNITS	MIN	TYP	MAX
ft	Gain Bandwidth at VCE = 1 V, IC = 5 mA, f = 2 GHz at VCE = 1 V, IC = 15 mA, f = 2 GHz	GHz GHz	3.0 5.0	4.5 6.5	–
S21E  <sup>2</sup>	Insertion Power Gain at VCE = 1 V, IC = 5 mA, f = 2 GHz at VCE = 1 V, IC = 15 mA, f = 2 GHz	dB dB	3.0 4.5	4.0 5.5	– –
NF	Noise Figure at VCE = 1 V, IC = 10 mA, f = 2 GHz	dB	–	1.9	2.5
CRE	Reverse Transfer Capacitance <sup>3</sup> at VCB = 0.5 V, IE = 0 mA, f = 1 MHz	pF	–	0.6	0.8
ICBO	Collector Cutoff Current at VCB = 5 V, IE = 0	nA	–	–	600
IEBO	Emitter Cutoff Current at VEB = 1 V, IC = 0	nA	–	–	600
hFE	DC Current Gain <sup>2</sup> at VCE = 1 V, IC = 5 mA		100	120	145

Notes:

1. Electronic Industrial Association of Japan.
2. Pulsed measurement, pulse width  $\leq 350 \mu s$ , duty cycle  $\leq 2\%$ .
3. Collector to base capacitance when the emitter is grounded



# NE851M13

## ABSOLUTE MAXIMUM RATINGS<sup>1</sup> (T<sub>A</sub> = 25°C)

SYMBOLS	PARAMETERS	UNITS	RATINGS
V <sub>CB0</sub>	Collector to Base Voltage	V	9
V <sub>CEO</sub>	Collector to Emitter Voltage	V	5.5
V <sub>EB0</sub>	Emitter to Base Voltage	V	1.5
I <sub>c</sub>	Collector Current	mA	100
P <sub>T2</sub>	Total Power Dissipation	mW	140
T <sub>J</sub>	Junction Temperature	°C	150
T <sub>STG</sub>	Storage Temperature	°C	-65 to +150

Notes:

1. Operation in excess of any one of these parameters may result in permanent damage.
2. With device mounted on 1.08 cm<sup>2</sup> X 1.0 mm glass epoxy board.

## ORDERING INFORMATION

PART NUMBER	QUANTITY
NE851M13-T3	10 k pcs./reel

## TYPICAL PERFORMANCE CURVES (T<sub>A</sub> = 25°C)

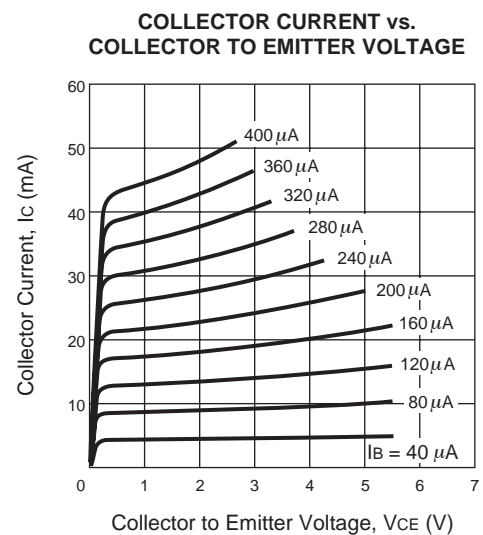
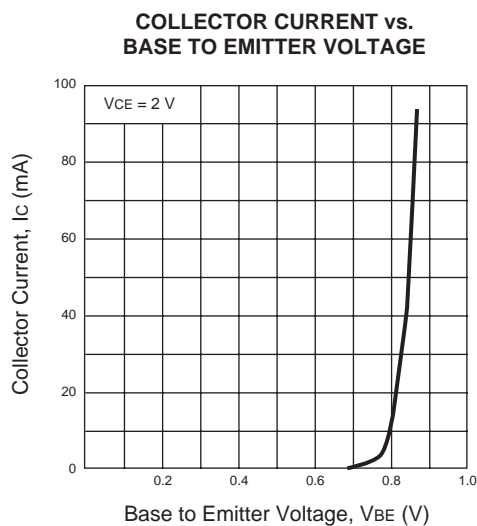
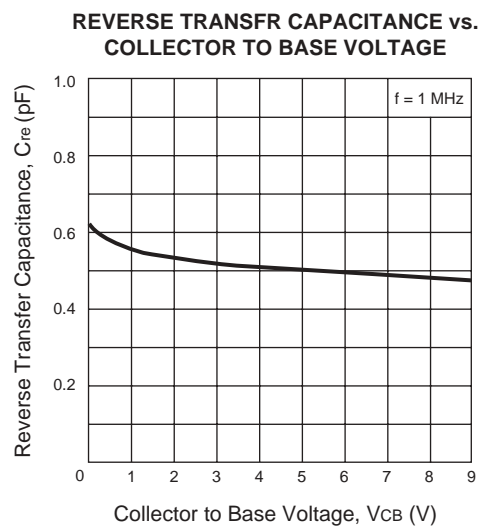
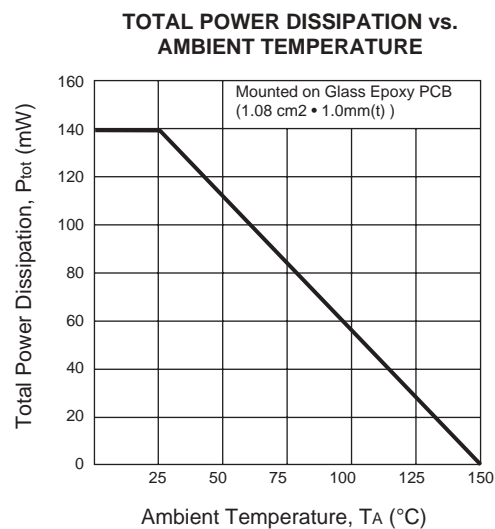

**TYPICAL PERFORMANCE CURVES** ( $T_A = 25^\circ\text{C}$ )

**GAIN BANDWIDTH PRODUCT vs. COLLECTOR CURRENT**

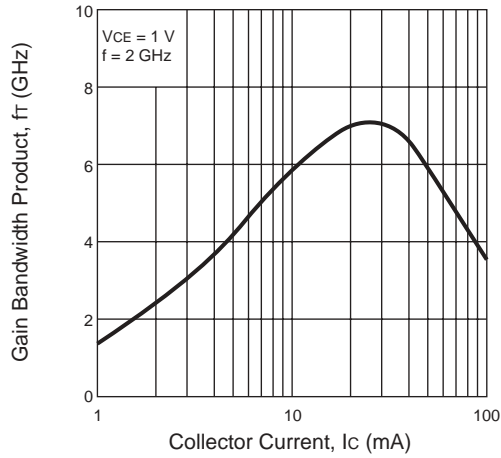

**GAIN BANDWIDTH PRODUCT vs. COLLECTOR CURRENT**

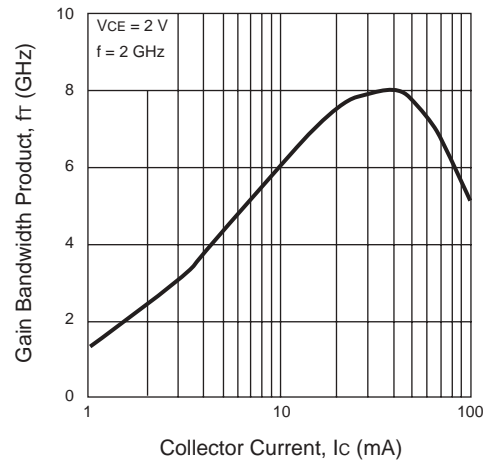

**INSERTION POWER GAIN vs. FREQUENCY**

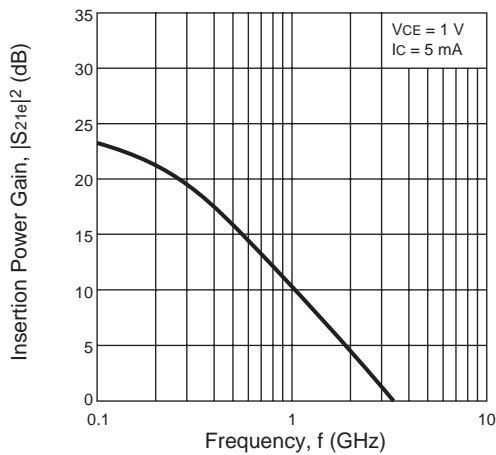

**INSERTION POWER GAIN vs. FREQUENCY**

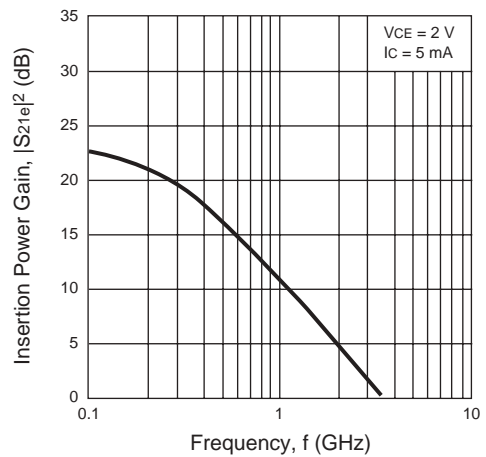

**INSERTION POWER GAIN vs. FREQUENCY**

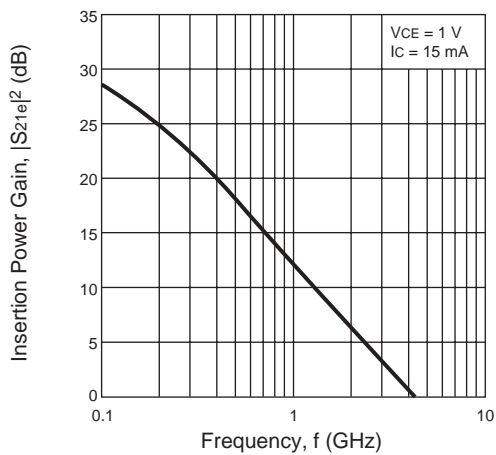

**INSERTION POWER GAIN vs. FREQUENCY**

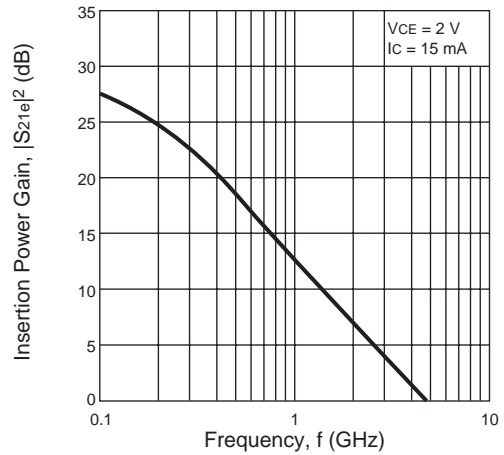

TYPICAL PERFORMANCE CURVES (TA = 25°C)

INSERTION POWER GAIN, MAG, MSG vs. COLLECTOR CURRENT

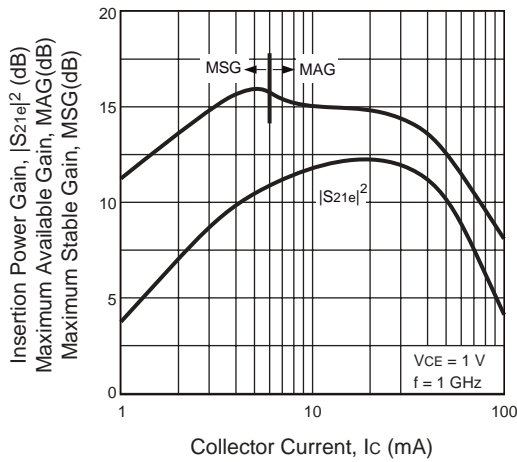

INSERTION POWER GAIN, MAG, MSG vs. COLLECTOR CURRENT

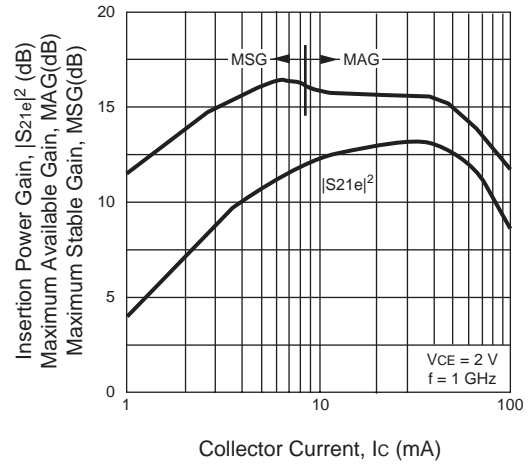

INSERTION POWER GAIN and MAG vs. COLLECTOR CURRENT

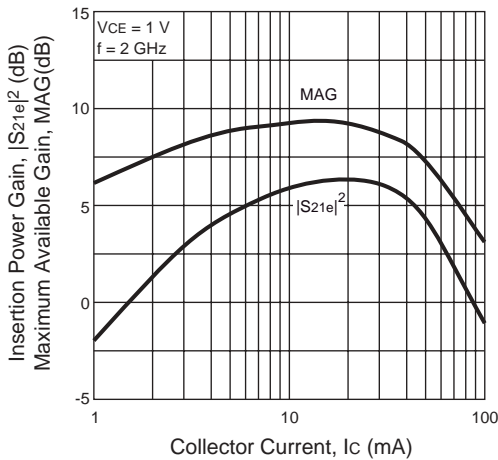

INSERTION POWER GAIN and MAG vs. COLLECTOR CURRENT

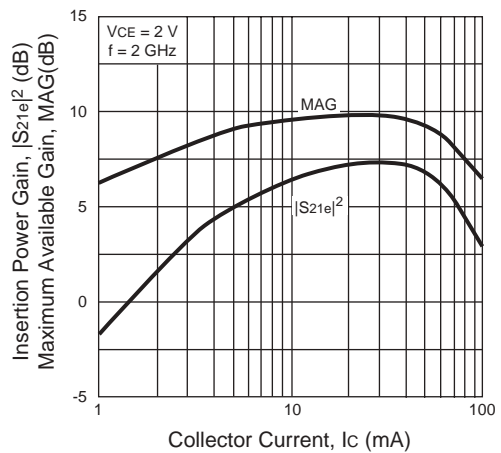

INSERTION POWER GAIN, MAG, MSG vs. COLLECTOR CURRENT

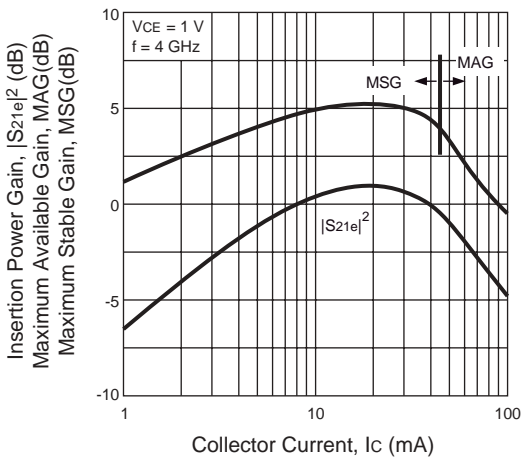

INSERTION POWER GAIN, MAG, MSG vs. COLLECTOR CURRENT

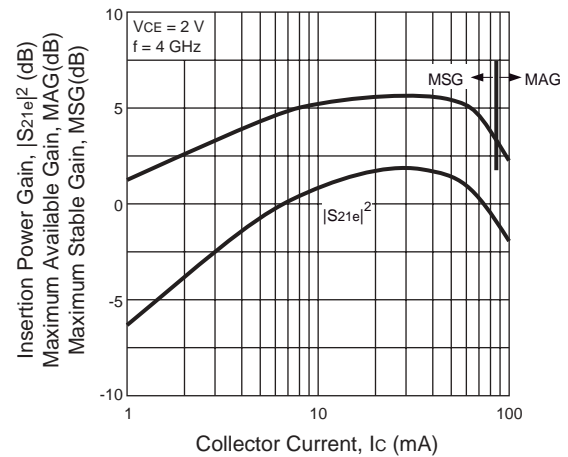

TYPICAL PERFORMANCE CURVES (T<sub>A</sub> = 25°C)

NOISE FIGURE and ASSOCIATED GAIN vs. COLLECTOR CURRENT

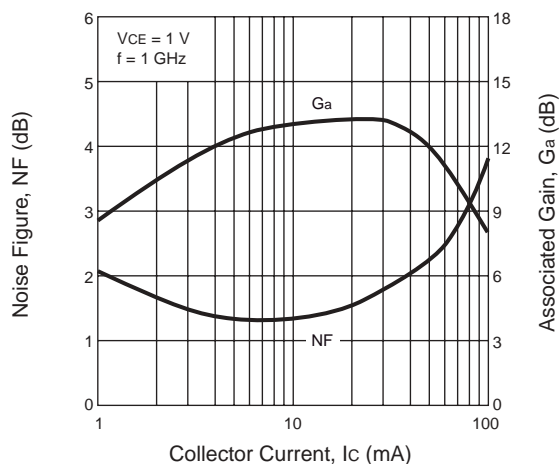

NOISE FIGURE and ASSOCIATED GAIN vs. COLLECTOR CURRENT

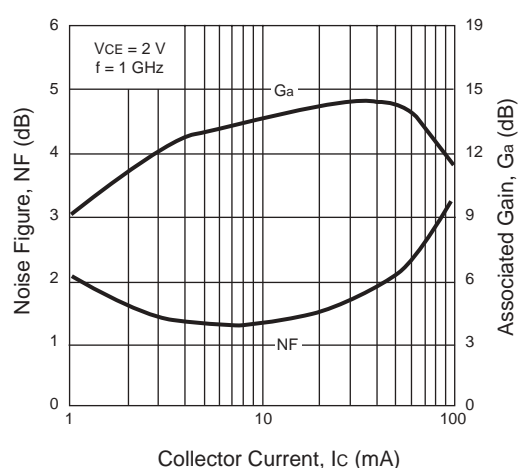

NOISE FIGURE and ASSOCIATED GAIN vs. COLLECTOR CURRENT

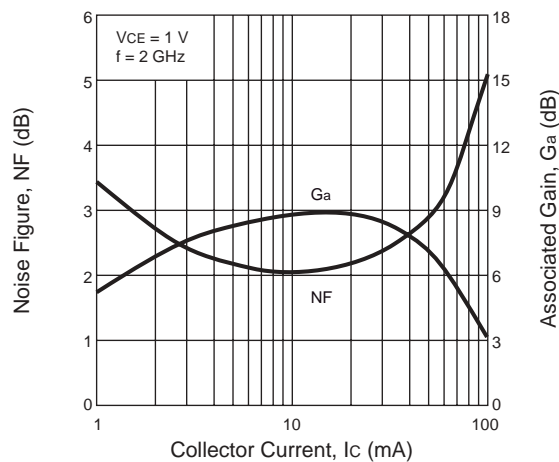

NOISE FIGURE and ASSOCIATED GAIN vs. COLLECTOR CURRENT

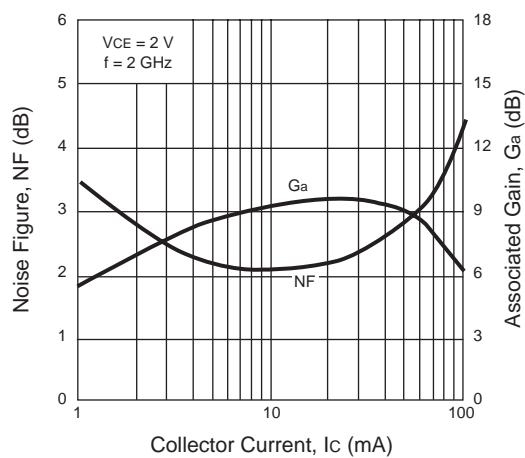

OUTPUT POWER AND COLLECTOR CURRENT vs. INPUT POWER

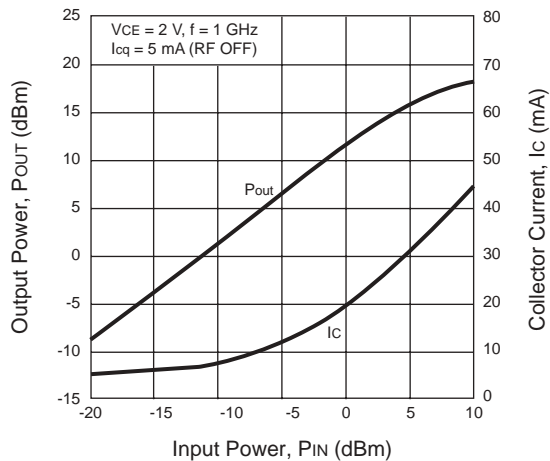

OUTPUT POWER AND COLLECTOR CURRENT vs. INPUT POWER

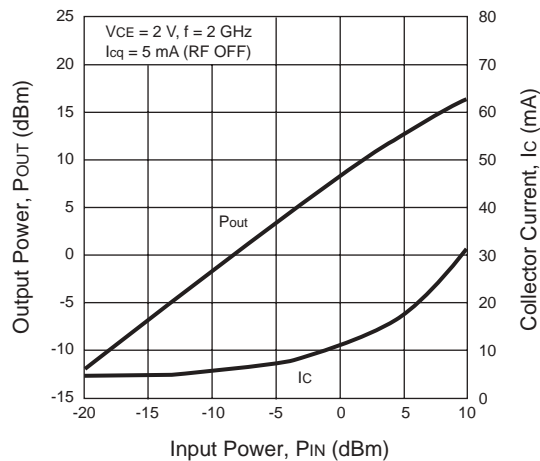

# NE851M13

## TYPICAL SCATTERING PARAMETERS (T<sub>A</sub> = 25°C)

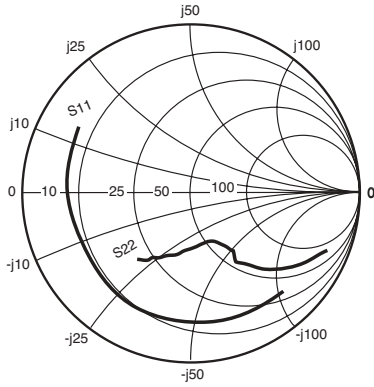

0.100 to 4.000 GHz by 0.050

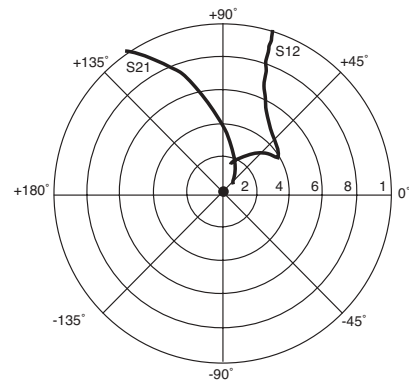

0.100 to 4.000GHz by 0.050

### NE851M13

V<sub>c</sub> = 1 V, I<sub>c</sub> = 5 mA

FREQUENCY GHz	S <sub>11</sub>		S <sub>21</sub>		S <sub>12</sub>		S <sub>22</sub>		K	MAG <sup>1</sup> (dB)
	MAG	ANG	MAG	ANG	MAG	ANG	MAG	ANG		
0.100	0.831	-46.49	13.764	152.54	0.036	66.4	0.901	-23.1	0.068	25.83
0.200	0.789	-81.92	11.335	132.55	0.058	50.3	0.742	-38.6	0.134	22.93
0.300	0.765	-106.07	9.135	118.99	0.069	40.9	0.618	-47.8	0.192	21.23
0.400	0.750	-122.16	7.476	109.52	0.075	35.5	0.533	-53.5	0.250	20.01
0.500	0.706	-133.99	6.157	103.05	0.077	33.0	0.460	-53.3	0.394	19.04
0.600	0.699	-142.06	5.251	97.76	0.078	31.6	0.414	-55.7	0.478	18.26
0.700	0.697	-148.74	4.576	93.13	0.080	31.0	0.382	-58.2	0.551	17.59
0.800	0.696	-153.88	4.062	89.34	0.081	31.4	0.363	-59.5	0.619	17.02
0.900	0.697	-158.33	3.646	85.83	0.082	32.0	0.350	-61.5	0.682	16.51
1.000	0.697	-161.97	3.308	82.71	0.082	33.1	0.339	-63.3	0.751	16.05
1.500	0.704	-174.56	2.262	69.58	0.087	41.9	0.328	-74.5	1.012	13.47
2.000	0.712	176.89	1.721	59.12	0.098	53.1	0.342	-86.9	1.152	10.09
2.500	0.724	169.88	1.391	50.09	0.118	62.5	0.376	-98.8	1.122	8.58
3.000	0.732	163.33	1.166	42.52	0.147	68.6	0.415	-109.4	1.042	7.75
3.500	0.743	156.42	1.002	36.21	0.182	71.3	0.458	-117.8	0.939	7.41
4.000	0.746	150.06	0.879	31.47	0.222	71.8	0.498	-125.3	0.877	5.98

Note:

1. Gain Calculations:

$$\text{MAG} = \frac{|S_{21}|}{|S_{12}|} \left( K \pm \sqrt{K^2 - 1} \right). \text{ When } K \leq 1, \text{ MAG is undefined and MSG values are used. } \text{MSG} = \frac{|S_{21}|}{|S_{12}|}, K = \frac{1 + |\Delta|^2 - |S_{11}|^2 - |S_{22}|^2}{2 |S_{12} S_{21}|}, \Delta = S_{11} S_{22} - S_{21} S_{12}$$

MAG = Maximum Available Gain

MSG = Maximum Stable Gain

**TYPICAL SCATTERING PARAMETERS** (T<sub>A</sub> = 25°C)

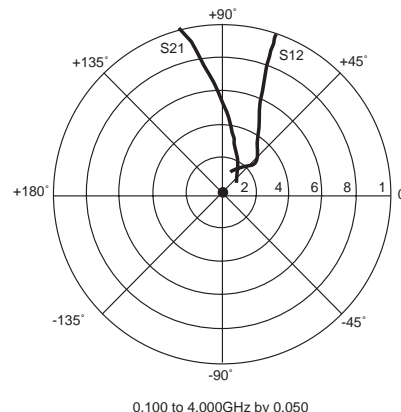
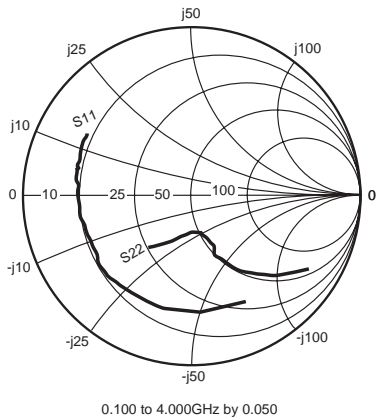

**NE851M13**

V<sub>c</sub> = 2 V, I<sub>c</sub> = 10 mA

FREQUENCY GHz	S <sub>11</sub>		S <sub>21</sub>		S <sub>12</sub>		S <sub>22</sub>		K	MAG <sup>1</sup> (dB)
	MAG	ANG	MAG	ANG	MAG	ANG	MAG	ANG		
0.100	0.718	-62.67	22.758	144.89	0.029	61.8	0.823	-32.5	0.135	28.99
0.200	0.689	-102.19	16.867	123.83	0.042	47.7	0.615	-50.6	0.239	26.05
0.300	0.680	-124.30	12.737	111.69	0.048	42.0	0.486	-60.3	0.334	24.22
0.400	0.677	-137.54	10.068	103.82	0.052	40.1	0.408	-66.1	0.423	22.85
0.500	0.648	-147.55	8.180	98.85	0.055	40.8	0.335	-65.2	0.582	21.74
0.600	0.645	-153.87	6.913	94.59	0.057	41.9	0.296	-67.9	0.679	20.81
0.700	0.647	-158.99	5.980	90.88	0.060	43.5	0.270	-70.9	0.755	19.98
0.800	0.648	-162.97	5.282	87.80	0.063	45.4	0.253	-72.1	0.819	19.23
0.900	0.651	-166.43	4.725	84.93	0.066	47.2	0.243	-74.0	0.871	18.55
1.000	0.652	-169.32	4.275	82.38	0.069	49.2	0.234	-75.8	0.922	17.92
1.500	0.661	-179.34	2.907	71.36	0.087	57.6	0.226	-86.3	1.059	13.75
2.000	0.669	173.47	2.212	62.32	0.109	63.9	0.241	-97.3	1.097	11.18
2.500	0.679	167.37	1.795	54.17	0.135	67.6	0.274	-107.0	1.061	9.73
3.000	0.687	161.58	1.515	47.00	0.164	69.6	0.311	-115.5	1.013	8.96
3.500	0.696	155.30	1.313	40.58	0.197	70.1	0.353	-121.7	0.947	8.24
4.000	0.699	149.56	1.161	35.18	0.232	69.6	0.393	-127.3	0.901	6.99

Note:

1. Gain Calculations:

$$MAG = \frac{|S_{21}|}{|S_{12}|} \left( K \pm \sqrt{K^2 - 1} \right). \text{ When } K \leq 1, \text{ MAG is undefined and MSG values are used. } MSG = \frac{|S_{21}|}{|S_{12}|}, K = \frac{1 + |\Delta|^2 - |S_{11}|^2 - |S_{22}|^2}{2 |S_{12} S_{21}|}, \Delta = S_{11} S_{22} - S_{21} S_{12}$$

MAG = Maximum Available Gain

MSG = Maximum Stable Gain

# NE851M13

## TYPICAL SCATTERING PARAMETERS (T<sub>A</sub> = 25°C)

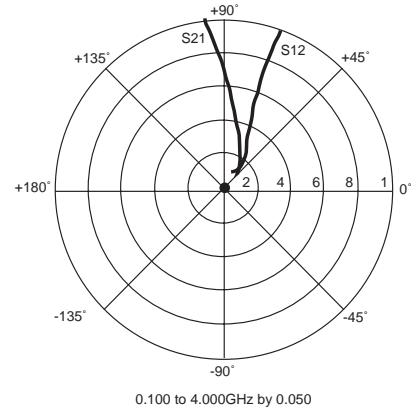
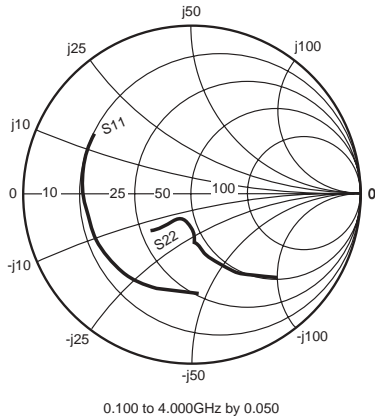

### NE851M13

V<sub>C</sub> = 3 V, I<sub>C</sub> = 20 mA

FREQUENCY GHz	S <sub>11</sub>		S <sub>21</sub>		S <sub>12</sub>		S <sub>22</sub>		K	MAG <sup>1</sup> (dB)
	MAG	ANG	MAG	ANG	MAG	ANG	MAG	ANG		
0.100	0.592	-86.11	33.025	135.40	0.022	57.5	0.710	-44.7	0.243	31.86
0.200	0.610	-124.37	21.656	115.31	0.031	48.3	0.483	-65.2	0.402	28.50
0.300	0.620	-141.71	15.554	105.23	0.036	47.6	0.370	-75.9	0.532	26.41
0.400	0.626	-151.34	12.032	98.91	0.040	49.1	0.309	-82.6	0.635	24.80
0.500	0.610	-159.31	9.710	95.19	0.044	52.1	0.241	-83.3	0.781	23.47
0.600	0.610	-163.96	8.162	91.77	0.048	54.4	0.212	-87.6	0.862	22.32
0.700	0.613	-167.68	7.032	88.75	0.052	56.5	0.194	-92.2	0.917	21.29
0.800	0.615	-170.58	6.194	86.21	0.057	58.6	0.181	-94.3	0.956	20.36
0.900	0.620	-173.15	5.529	83.82	0.062	60.3	0.173	-96.9	0.983	19.53
1.000	0.621	-175.39	4.996	81.67	0.067	61.8	0.167	-99.4	1.010	18.15
1.500	0.632	-176.71	3.387	72.14	0.092	66.6	0.166	-109.9	1.059	14.16
2.000	0.639	-170.54	2.578	64.13	0.119	69.0	0.183	-118.5	1.064	11.79
2.500	0.648	-165.15	2.096	56.72	0.148	69.7	0.214	-124.5	1.035	10.35
3.000	0.654	-159.90	1.775	50.03	0.178	69.5	0.248	-129.5	1.005	9.56
3.500	0.662	-154.05	1.546	43.87	0.210	68.7	0.285	-132.5	0.963	8.68
4.000	0.664	-148.76	1.376	38.44	0.243	67.5	0.321	-135.5	0.929	7.54

Note:

1. Gain Calculations:

$$\text{MAG} = \frac{|S_{21}|}{|S_{12}|} \left( K \pm \sqrt{K^2 - 1} \right). \text{ When } K \leq 1, \text{ MAG is undefined and MSG values are used. } \text{MSG} = \frac{|S_{21}|}{|S_{12}|}, K = \frac{1 + |\Delta|^2 - |S_{11}|^2 - |S_{22}|^2}{2 |S_{12} S_{21}|}, \Delta = S_{11} S_{22} - S_{21} S_{12}$$

MAG = Maximum Available Gain

MSG = Maximum Stable Gain



## NONLINEAR MODEL

### SCHEMATIC

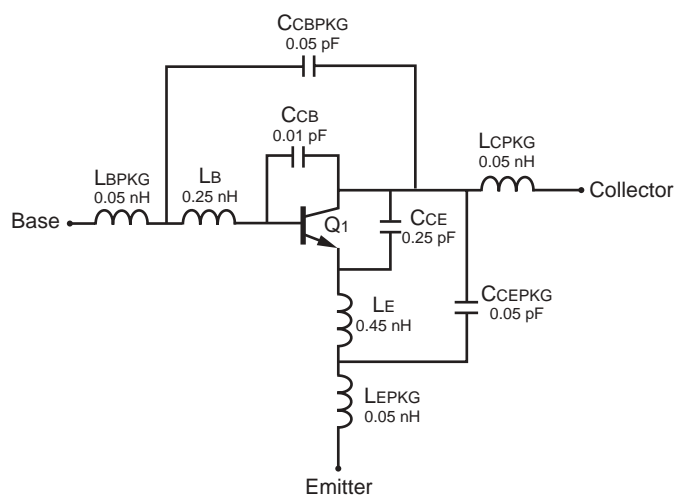

### BJT NONLINEAR MODEL PARAMETERS(1)

Parameters	Q1	Parameters	Q1
IS	137e-18	MJC	0.14
BF	166	XCJC	0.5
NF	0.9871	CJS	0
VAF	20.4	VJS	0.75
IKF	50	MJS	0
ISE	80.4e-15	FC	0.55
NE	2.4	TF	15e-12
BR	28.7	XTF	0.1
NR	0.9889	VTF	2
VAR	2.7	ITF	0.03
IKR	0.021	PTF	0
ISC	532e-18	TR	1.0e-9
NC	1.28	EG	1.11
RE	0.45	XTB	0
RB	4	XTI	3
RBM	1	KF	170e-15
IRB	0	AF	1.65
RC	1.7		
CJE	2.4e-12		
VJE	0.87		
MJE	0.34		
CJC	0.65e-12		
VJC	0.52		

(1) Gummel-Poon Model

#### Life Support Applications

These NEC products are not intended for use in life support devices, appliances, or systems where the malfunction of these products can reasonably be expected to result in personal injury. The customers of CEL using or selling these products for use in such applications do so at their own risk and agree to fully indemnify CEL for all damages resulting from such improper use or sale.

### ADDITIONAL PARAMETERS

Parameters	NE851M13
CCB	0.01 pF
CCE	0.25 pF
LB	0.25 nH
LE	0.45 nH
CCBPKG	0.05 pF
CCEPKG	0.05 pF
LBX	0.05 nH
LCX	0.05 nH
LEX	0.05 nH

#### MODEL TEST CONDITIONS

Frequency: 0.1 to 5.0 GHz  
 Bias:  $V_{CE} = 1\text{ V to }4\text{ V}$ ,  $I_C = 1\text{ mA to }40\text{ mA}$   
 Date: 09/2001