



HIGH SPEED PIN PHOTO DIODE

■ GENERAL DESCRIPTION

The NJL6163R is the PIN photo diode, which attain high speed ($f_c : 200\text{MHz}$) and high sensitivity ($S : 0.65\text{A/W}$).

It shrinks the outline by COBP(Chip on Board Package), and attain under half package volume compared with lead frame type.

■ FEATURES

- High speed, high sensitivity
- Super miniature, super thin type (2.5mmX4.9mmX1.16mm)

■ APPLICATIONS

- Laser monitor for CD-R/RW etc.
- Reading the signal for optical communication etc.

■ OUTLINE (typ.) Unit : mm

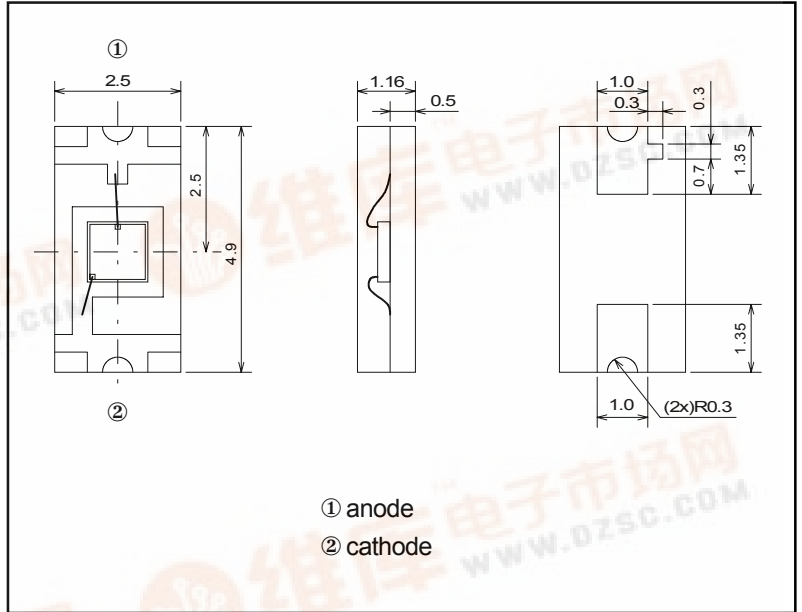

■ ABSOLUTE MAXIMUM RATINGS (Ta=25°C)

PARAMETER	SYMBOL	RATINGS	UNIT
Reverse Voltage	VR	35	V
Operating Temperature	Topr	-30 ~ +85	°C
Storage Temperature	Tstg	-40 ~ +100	°C
Soldering Temperature	Tsol	260 (10sec.)	°C

■ ELECTRO-OPTICAL CHARACTERISTICS (Ta=25°C)

PARAMETER	SYMBOL	TEST CONDITION	MIN	TYP	MAX	UNIT
Dark Current	ID	VR=10V	—	0.1	2.0	nA
Forward Voltage	VF	IF=1mA	—	—	1.0	V
Capacitance	Ct	VR=2.0V, f=1MHz	—	10	—	pF
Peak Wavelength	λ_P	—	—	800	—	nm
Sensitivity	S	VR=2.0V, $\lambda=780\text{nm}$	0.50	0.65	—	A/W
Cut off Frequency	fc	VR=0.7V, $\lambda=780\text{nm}$, RL=50Ω	—	150	—	MHz
		VR=2.0V, $\lambda=780\text{nm}$, RL=50Ω (-3dB)	—	200	—	MHz



NJL6163R

TYPICAL CHARACTERISTICS

Relative Sensitivity vs. Illuminance (Ta=25°C)

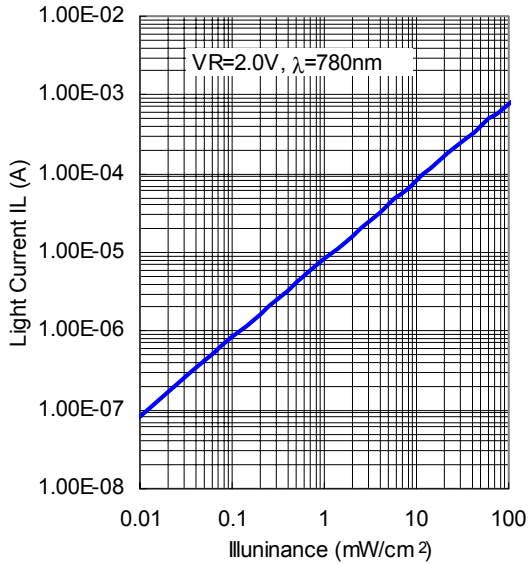

Spectral Response (Ta=25°C)

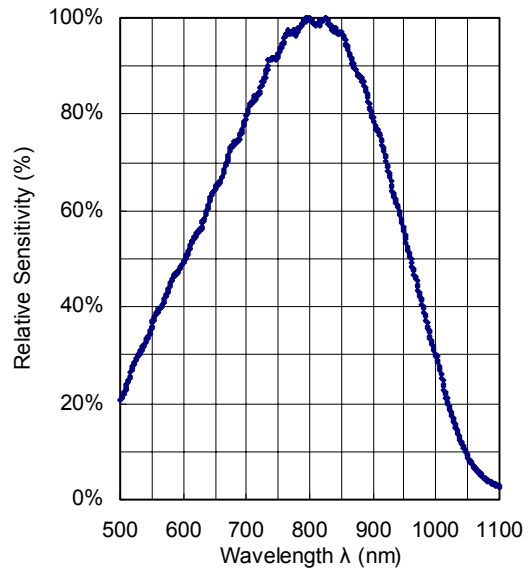

Dark Current vs. Temperature

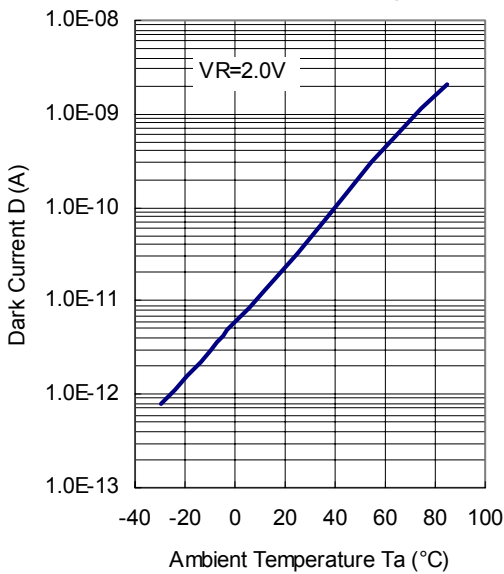

Relative Sensitivity vs. Temperature

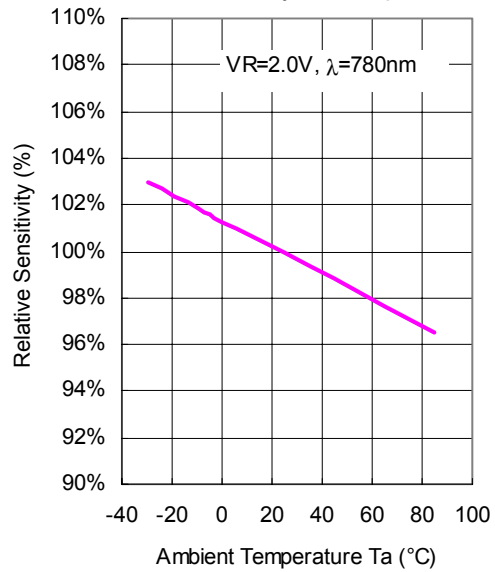

Rise Time vs. Reverse Voltage (Ta=25°C)

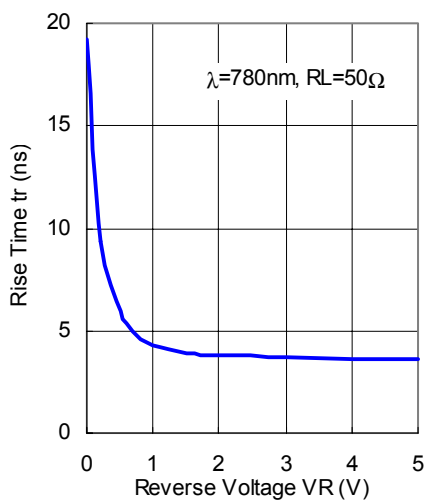

Fall Time vs. Reverse Voltage (Ta=25°C)

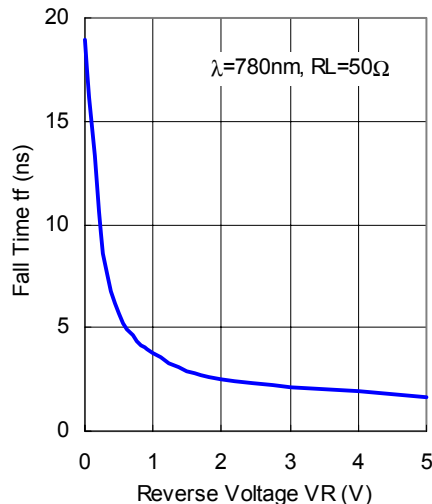

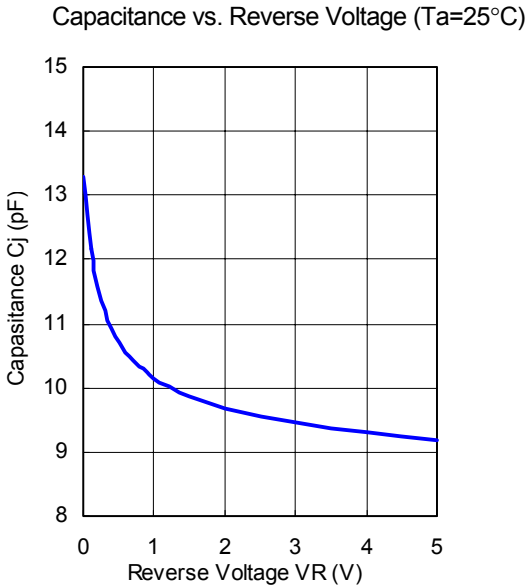
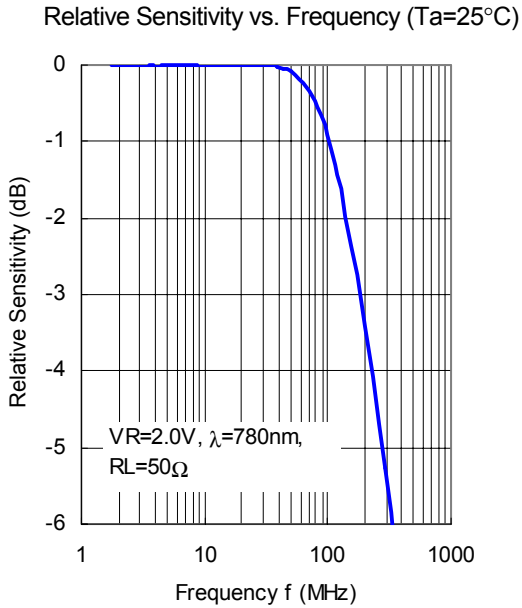

MEASURING CIRCUIT FOR RESPONSE TIME

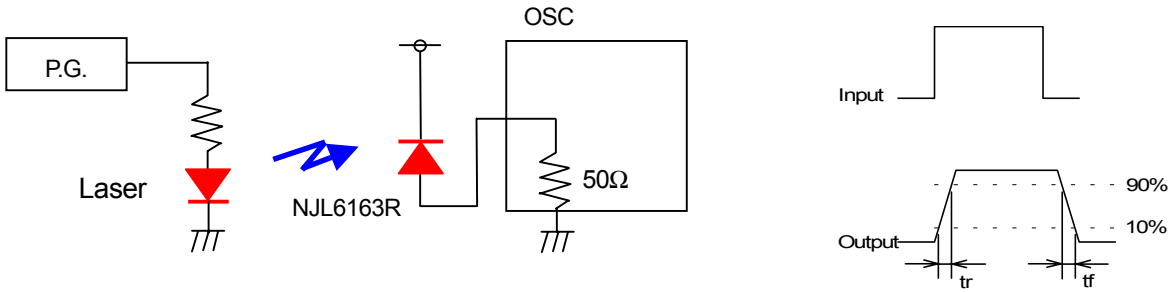

NJL6163R

PRECAUTION FOR HANDLING

1. Soldering to actual circuit board

Soldering condition

- Heated condition of plastic package.

Lower than 240°C of maximum surface temperature, less than 30 seconds of time kept higher than 200°C.

Soldering Method

1) Reflow Method

Recommended temperature profile of its method.

- ① Preparatory heating condition : 120 ~ 150°C about 60 sec.
- ② Recommended soldering temperature : 230 ~ 240°C about 3 ~ 5 sec.
- ③ Slowly cool down right after soldering.
- ④ Soldering to be done within twice under this condition.

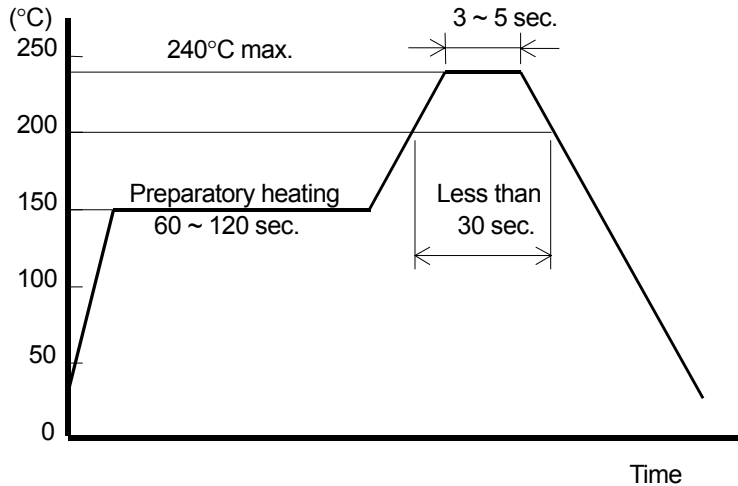

2) Reflow Method (In case of infrared heating)

- Temperature profile : Same to the above

- Avoid direct irradiation to the plastic package because it is mold resin, absorbs the Infrared Radiation and its surface temperature will be higher than lead itself.

3) The other method

Avoid rapid heating up like dipping the devices directly into the melting solder or vapor phase method (VPS).

If the device is heated to high temperature and kept in its condition for longer time, it would affect to its reliability.

It is necessary to solder in short time as soon as possible.

2. Cleaning

Avoid washing of the device after soldering by reflow method.

3. Attention in handling

- 1) Treat not to touch the lens surface.
- 2) Avoid dust and any other foreign materials (paint, bonding material, etc.) on the lens surface.
- 3) When mounting, special care has to be taken on the mounting position and tilting of the device because it is very important to place the device to the optimum position to the object.

4. Storage

In order to prevent from degradation of this device in moisturing at reflow method, so that this device is contained in dampproof packaging. So that mount the device as short as possible after opening the envelope.

NJL6163R Taping Specification

(TE1)

1. Taping Size

- 1) Carrier tape is used with Styrene type Carbonated Plastic.
- 2) Cover tape is used with electro statistically prevention treated Polyester type tape.
- 3) Product taping direction is to place the index mark against the pull out direction of the tape as in the drawing.

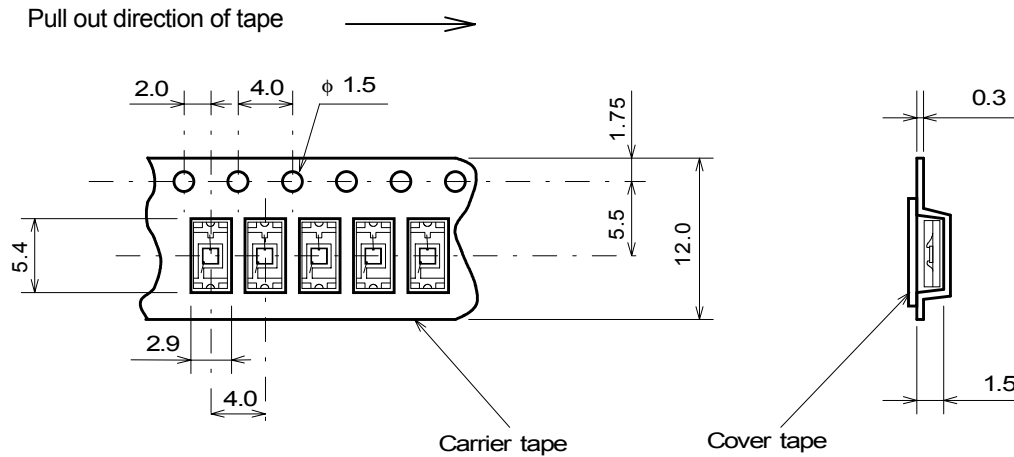

2. Taping Strength

Pullup the cover tape from the carrier tape, and when the opening angle comes around 10 ~ 15°, and the peeling-off strength is to be within the power of 20 ~ 70g.

3. Packaging

- 1) The taped products are to be rolled up on the taping reel as on the drawing.
- 2) Rolling up specification
 - ① Start Rolling : Carrier tape open space more than 20 Pieces.
 - ② End of Rolling : Carrier tape open space more than 20 Pieces, and 2 round of reel space at the cover tape only.
- 3) Taping quantity : 2,000 Pieces
- 4) Seal off after putting each reels in a dampproof bag with silica gel (3 bags).

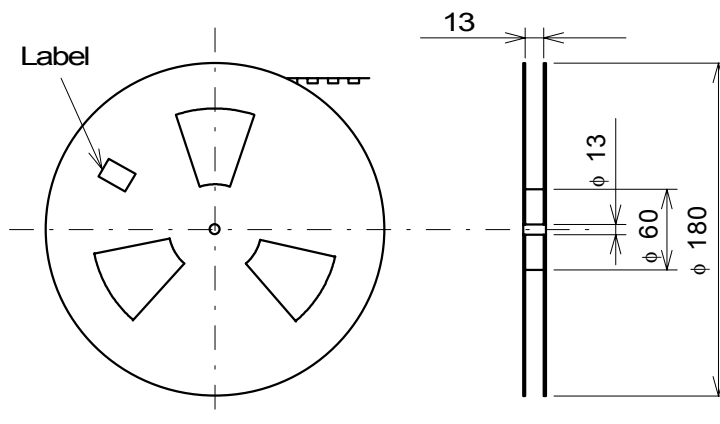

NJL6163R

MEMO

[CAUTION]

The specifications on this databook are only given for information, without any guarantee as regards either mistakes or omissions. The application circuits in this databook are described only to show representative usages of the product and not intended for the guarantee or permission of any right including the industrial rights.